

User Manual



WCA230A & WCA280A 3 GHz & 8 GHz Portable Wireless Communication Analyzers 071-1253-02

This document applies to firmware version 2.0
and above.

www.tektronix.com

Copyright © Tektronix Japan, Ltd. All rights reserved.

Copyright © Tektronix, Inc. All rights reserved.

Tektronix products are covered by U.S. and foreign patents, issued and pending. Information in this publication supercedes that in all previously published material. Specifications and price change privileges reserved.

Tektronix Japan, Ltd., Shinagawa Intercity Building B 6th Floor, 2-15-2 Konan, Minato-ku, Tokyo 108-6106 Japan
Tektronix, Inc., P.O. Box 500, Beaverton, OR 97077

TEKTRONIX and TEK are registered trademarks of Tektronix, Inc.

Windows and Windows 98 are trademarks of Microsoft Corporation.

End User License Agreement for Windows 98

You have acquired a device ("DEVICE") that includes software licensed by Tektronix Japan, Ltd. ("TJ") from Microsoft Licensing Inc. or its affiliates ("MS"). Those installed software products of MS origin, as well as associated media, printed materials, and "online" or electronic documentation ("SOFTWARE") are protected by international intellectual property laws and treaties. The SOFTWARE is licensed, not sold. All rights reserved.

IF YOU DO NOT AGREE TO THIS END USER LICENSE AGREEMENT ("EULA"), DO NOT USE THE DEVICE OR COPY THE SOFTWARE. INSTEAD, PROMPTLY CONTACT TJ FOR INSTRUCTIONS ON RETURN OF THE UNUSED DEVICE(S) FOR A REFUND. ANY USE OF THE SOFTWARE, INCLUDING BUT NOT LIMITED TO USE ON THE DEVICE, WILL CONSTITUTE YOUR AGREEMENT TO THIS EULA (OR RATIFICATION OF ANY PREVIOUS CONSENT).

GRANT OF SOFTWARE LICENSE. This EULA grants you the following license:

You may use the SOFTWARE only on the DEVICE.

NOT FAULT TOLERANT.

THE SOFTWARE IS NOT FAULT TOLERANT. TJ HAS INDEPENDENTLY DETERMINED HOW TO USE THE SOFTWARE IN THE DEVICE, AND MS HAS RELIED UPON TJ TO CONDUCT SUFFICIENT TESTING TO DETERMINE THAT THE SOFTWARE IS SUITABLE FOR SUCH USE.

NO WARRANTIES FOR THE SOFTWARE.

THE SOFTWARE IS PROVIDED "AS IS" AND WITH ALL FAULTS. THE ENTIRE RISK AS TO SATISFACTORY QUALITY, PERFORMANCE, ACCURACY, AND EFFORT (INCLUDING LACK OF NEGLIGENCE) IS WITH YOU. ALSO, THERE IS NO WARRANTY AGAINST INTERFERENCE WITH YOUR ENJOYMENT OF THE SOFTWARE OR AGAINST INFRINGEMENT. IF YOU HAVE RECEIVED ANY WARRANTIES REGARDING THE DEVICE OR THE SOFTWARE, THOSE WARRANTIES DO NOT ORIGINATE FROM, AND ARE NOT BINDING ON, MS.

NOTE ON JAVA SUPPORT.

The SOFTWARE may contain support for programs written in Java. Java technology is not fault tolerant and is not designed, manufactured, or intended for use or resale as online control equipment in hazardous environments requiring fail-safe performance, such as in the operation of nuclear facilities, aircraft navigation or communication systems, air traffic control, direct life support machines, or weapons systems, in which the failure of Java technology could lead directly to death, personal injury, or severe physical or environmental damage. Sun Microsystems, Inc. has contractually obligated MS to make this disclaimer.

NO LIABILITY FOR CERTAIN DAMAGES.

EXCEPT AS PROHIBITED BY LAW, MS SHALL HAVE NO LIABILITY FOR ANY INDIRECT, SPECIAL, CONSEQUENTIAL OR INCIDENTAL DAMAGES ARISING FROM OR IN CONNECTION WITH THE USE OR PERFORMANCE OF THE SOFTWARE. THIS LIMITATION SHALL APPLY EVEN IF ANY REMEDY FAILS OF ITS ESSENTIAL PURPOSE. IN NO EVENT SHALL MS BE LIABLE FOR ANY AMOUNT IN EXCESS OF U.S. TWO HUNDRED FIFTY DOLLARS (U.S.\$250.00).

LIMITATIONS ON REVERSE ENGINEERING, DECOMPILATION, AND DISASSEMBLY.

You may not reverse engineer, decompile, or disassemble the SOFTWARE, except and only to the extent that such activity is expressly permitted by applicable law notwithstanding this limitation.

SOFTWARE TRANSFER ALLOWED BUT WITH RESTRICTIONS.

You may permanently transfer rights under this EULA only as part of a permanent sale or transfer of the Device, and only if the recipient agrees to this EULA. If the SOFTWARE is an upgrade, any transfer must also include all prior versions of the SOFTWARE.

EXPORT RESTRICTIONS.

You acknowledge that SOFTWARE is of US–origin. You agree to comply with all applicable international and national laws that apply to the SOFTWARE, including the U.S. Export Administration Regulations, as well as end–user, end–use and country destination restrictions issued by U.S. and other governments. For additional information on exporting the SOFTWARE, see <http://www.microsoft.com/exporting/>.

LIMITATION ON SOFTWARE PROGRAMS USED ON THE DEVICE.

The combination of software programs you use on the DEVICE shall address not more than two (2) general office automation or consumer computing functions. Such functions include, but are not limited to: email, word processing, spreadsheets, database, network browsing, scheduling, and personal finance.

STORAGE/NETWORK USE.

The SOFTWARE may not be installed, accessed, displayed, run, shared or used concurrently on or from different computers, including a workstation, terminal or other digital electronic device (“Computing System”). Notwithstanding the foregoing and except as otherwise provided below, any number of Computing Systems, may access or otherwise utilize the file and print services and internet information services of the SOFTWARE, if included.

You may use the SOFTWARE on a single DEVICE as interactive workstation software, but not as server software. However, you may permit a maximum of ten (10) Computing Systems to connect to the DEVICE to access and use services of the SOFTWARE, such as file and print services and internet information services. The ten–connection maximum includes any indirect connections made through other software or hardware which pools or aggregates connections.

Hardware Warranty

Tektronix warrants that the products that it manufactures and sells will be free from defects in materials and workmanship for a period of one (1) year from the date of shipment. If a product proves defective during this warranty period, Tektronix, at its option, either will repair the defective product without charge for parts and labor, or will provide a replacement in exchange for the defective product.

In order to obtain service under this warranty, Customer must notify Tektronix of the defect before the expiration of the warranty period and make suitable arrangements for the performance of service. Customer shall be responsible for packaging and shipping the defective product to the service center designated by Tektronix, with shipping charges prepaid. Tektronix shall pay for the return of the product to Customer if the shipment is to a location within the country in which the Tektronix service center is located. Customer shall be responsible for paying all shipping charges, duties, taxes, and any other charges for products returned to any other locations.

This warranty shall not apply to any defect, failure or damage caused by improper use or improper or inadequate maintenance and care. Tektronix shall not be obligated to furnish service under this warranty a) to repair damage resulting from attempts by personnel other than Tektronix representatives to install, repair or service the product; b) to repair damage resulting from improper use or connection to incompatible equipment; c) to repair any damage or malfunction caused by the use of non-Tektronix supplies; or d) to service a product that has been modified or integrated with other products when the effect of such modification or integration increases the time or difficulty of servicing the product.

THIS WARRANTY IS GIVEN BY TEKTRONIX IN LIEU OF ANY OTHER WARRANTIES, EXPRESS OR IMPLIED. TEKTRONIX AND ITS VENDORS DISCLAIM ANY IMPLIED WARRANTIES OF MERCHANTABILITY OR FITNESS FOR A PARTICULAR PURPOSE. TEKTRONIX' RESPONSIBILITY TO REPAIR OR REPLACE DEFECTIVE PRODUCTS IS THE SOLE AND EXCLUSIVE REMEDY PROVIDED TO THE CUSTOMER FOR BREACH OF THIS WARRANTY. TEKTRONIX AND ITS VENDORS WILL NOT BE LIABLE FOR ANY INDIRECT, SPECIAL, INCIDENTAL, OR CONSEQUENTIAL DAMAGES IRRESPECTIVE OF WHETHER TEKTRONIX OR THE VENDOR HAS ADVANCE NOTICE OF THE POSSIBILITY OF SUCH DAMAGES.

Software Warranty

Tektronix warrants that the media on which this software product is furnished and the encoding of the programs on the media will be free from defects in materials and workmanship for a period of three (3) months from the date of shipment. If a medium or encoding proves defective during the warranty period, Tektronix will provide a replacement in exchange for the defective medium. Except as to the media on which this software product is furnished, this software product is provided "as is" without warranty of any kind, either express or implied. Tektronix does not warrant that the functions contained in this software product will meet Customer's requirements or that the operation of the programs will be uninterrupted or error-free.

In order to obtain service under this warranty, Customer must notify Tektronix of the defect before the expiration of the warranty period. If Tektronix is unable to provide a replacement that is free from defects in materials and workmanship within a reasonable time thereafter, Customer may terminate the license for this software product and return this software product and any associated materials for credit or refund.

THIS WARRANTY IS GIVEN BY TEKTRONIX IN LIEU OF ANY OTHER WARRANTIES, EXPRESS OR IMPLIED. TEKTRONIX AND ITS VENDORS DISCLAIM ANY IMPLIED WARRANTIES OF MERCHANTABILITY OR FITNESS FOR A PARTICULAR PURPOSE. TEKTRONIX' RESPONSIBILITY TO REPLACE DEFECTIVE MEDIA OR REFUND CUSTOMER'S PAYMENT IS THE SOLE AND EXCLUSIVE REMEDY PROVIDED TO THE CUSTOMER FOR BREACH OF THIS WARRANTY. TEKTRONIX AND ITS VENDORS WILL NOT BE LIABLE FOR ANY INDIRECT, SPECIAL, INCIDENTAL, OR CONSEQUENTIAL DAMAGES IRRESPECTIVE OF WHETHER TEKTRONIX OR THE VENDOR HAS ADVANCE NOTICE OF THE POSSIBILITY OF SUCH DAMAGES.

Service Options

Tektronix provides service to cover repair under warranty as well as other services that are designed to meet your specific service needs. Advancing technology has brought incredible change to the power of measurement instruments. Manufacturing methods and calibration techniques have been revolutionized, making the service challenge tougher than ever. By using Tektronix as your service provider you make use of our technology and product knowledge, our world-wide logistics infrastructure, and our ISO9000 approved service centers. Tektronix technicians are trained on the latest products and are equipped with the most current information on product improvements and upgrades for optimum product performance.

Warranty Repair Service. Tektronix technicians provide warranty service at most Tektronix service locations worldwide. The warranty period for this product can be found behind the title page in this manual.

Calibration and Repair Service. Tektronix offers calibrations, non-warranty repair, and support for customers performing their own service. Where appropriate, calibrations are compliant to ANSI/NCSL Z-540/ISO17025 and ISO9000 Quality Systems. If you prefer to perform your own service, Tektronix supports repair to the replaceable-part level through providing for circuit board exchange. All services can be purchased through a variety of agreements to fit your specific requirements.

For more information regarding service offerings or service locations worldwide, please see the Tektronix product catalog or visit us on our Customer Services World Center web site at:

<http://www.tek.com/Measurement/Service>.

Table of Contents

General Safety Summary	xiii
Preface	xv
About This Manual	xv
Related Documents	xvi
Conventions	xvii
Contacting Tektronix	xviii

Getting Started

Product Overview	1-1
Features	1-1
Application	1-2
Difference between WCA230A and WCA280A	1-2
Real-Time Analysis	1-3
Architecture	1-6
Installation	1-9
Unpacking to Check Contents	1-9
Applying Power	1-10
Setting Up the Stand	1-13
Functional Check	1-14
Powering Off the Analyzer	1-18
Restart	1-19
Backing Up User Files	1-20
About Installation of Other Applications	1-20
Calibration	1-21
Gain Calibration	1-21
Center Offset Calibration	1-23
DC Offset Calibration	1-24
Display Brightness Adjustment	1-25
Confirming Performance	1-25

Operating Basics

Functional Overview	2-1
Interface Maps	2-1
Menu Operations	2-11
Menu Functions	2-17
Measurement Menu	2-18
Display Menu	2-32
Utility Menu	2-37
Tutorial	2-43
Preparations	2-44
Displaying Spectrum	2-48
Using Markers and Peak Search	2-57
Using Averaging and Comparison Displays	2-63
Displaying a Spectrogram	2-66
Spectrum Analysis	2-69

Modulation Analysis	2-73
Turning Off the Power	2-80

Reference

Spectrum Analysis (S/A Mode)	3-1
Measurement Screen Layout	3-2
Spectrum Analysis	3-4
Channel Power Measurement	3-5
ACPR Measurement	3-7
C/N Measurement	3-9
OBW Measurement	3-11
Carrier Frequency Measurement	3-13
EBW Measurement	3-15
Spurious Signal Measurement	3-17
Spectrogram Display	3-20
Real-Time Analysis	3-22
Modulation Analysis (Demod Mode)	3-27
Layout of the Measurement Screen	3-28
Analog Modulation Analysis	3-35
Digital Modulation Analysis	3-42
Time Analysis (Time Mode)	3-53
Measurement Screen Layout	3-54
Time Variation Measurement	3-56
CCDF Measurement	3-60
Scale and Format of Views	3-63
Basic Procedure	3-64
Setting up the Spectrum View	3-65
Setting up the Spectrogram View	3-66
Setting up the Time Domain View	3-68
Setting up the CCDF View	3-70
Setting up the Constellation View	3-71
Setting up the EVM View	3-72
Setting up the Symbol Table	3-75
Setting up the Eye Diagram	3-76
Setting Frequency and Span	3-79
Basic Procedure	3-80
Setting Range	3-83
Vector Span	3-85
Setting Amplitude	3-87
Basic Procedure	3-87
Over-Voltage Input	3-90
Amplitude Correction	3-91
Selecting Input Source	3-99
FFT and RBW	3-101
Setting RBW/FFT Parameters	3-102
FFT Points	3-103
FFT Window	3-104

Acquiring Data	3-109
Starting/Stopping Data Acquisition	3-109
Seamless Acquisition	3-111
Time Parameters (Real Time S/A, Demod, and Time Modes Only)	3-112
Trigger	3-115
Setting Trigger	3-116
IF Trigger	3-120
Creating a Trigger Mask (Option 02 Only)	3-123
Trigger Point Indicator	3-130
Trace Comparison Display and Average Function	3-131
Displaying Trace 1 and 2	3-132
Averaging the Waveform	3-133
Saving/Loading Waveform Data	3-137
Trace Compression	3-138
Marker Operation and Peak Search	3-141
Marker Operation	3-141
Peak Search	3-147
Display Line	3-149
Horizontal Display Line	3-151
Vertical Display Line	3-152
File Operations	3-153
Using a Disk	3-153
File Type	3-154
Saving and Loading Files	3-154
Entering a File Name	3-160
Deleting a File	3-162
Creating/Deleting a Directory	3-162
File Format	3-163
Data File Format	3-163
Trace File Format	3-171
Connecting to LAN	3-175
Attaching a Cable	3-175
Network Settings	3-176
Sharing Resources	3-176
Connecting USB Devices	3-177
Using Windows 98	3-179
Connecting a Mouse and Keyboard	3-179
Starting Windows 98 Applications	3-179
Setting Date and Time	3-179
Displaying the Windows Desktop Screen	3-179
Switching from Windows 98 to the Analyzer View	3-180
Screen Copy	3-181
Print Menu	3-181
Printing a Screen Copy	3-182
Creating a File	3-184
Using the Online Help	3-185
Displaying the Online Help	3-185
Using a Mouse and Keyboard	3-188

Displaying the Version and Options 3-189

Appendices

Appendix A: Specifications A-1
Electrical Characteristics A-1
Physical Characteristics A-15
Environmental Characteristics A-15

Appendix B: Default Settings B-1

Appendix C: Inspection and Cleaning C-1
Inspecting the Exterior C-1
Cleaning the Exterior C-2
Lubrication C-2
Cleaning the Interior C-2

Appendix D: Options and Accessories D-1
Options D-1
Standard Accessories D-3
Optional Accessories D-4

Glossary

Index

List of Figures

Figure 1–1: Concept of the swept spectrum analyzer	1–3
Figure 1–2: Sweep of resolution filter	1–3
Figure 1–3: Concept of the real-time spectrum analyzer	1–4
Figure 1–4: Concurrent acquisition	1–4
Figure 1–5: Frame acquisition	1–5
Figure 1–6: Block diagram	1–6
Figure 1–7: AC Input (rear panel)	1–10
Figure 1–8: Principal power switch (rear panel)	1–11
Figure 1–9: Front panel power switch (ON/STANDBY switch)	1–11
Figure 1–10: Initial screen	1–12
Figure 1–11: RF INPUT connector	1–12
Figure 1–12: Setting up the stand	1–13
Figure 1–13: Spectrum of the calibration signal (50 MHz, about –20 dBm)	1–14
Figure 1–14: Setup display	1–15
Figure 1–15: Reference level setting and A/D overflow indicator ...	1–16
Figure 1–16: Spectrogram display	1–17
Figure 1–17: UNCAL display	1–21
Figure 1–18: Calibration menu	1–22
Figure 1–19: Center offset	1–23
Figure 1–20: DC offset	1–24
Figure 1–21: System menu	1–25
Figure 2–1: Front panel	2–1
Figure 2–2: Rear panel	2–2
Figure 2–3: Side panel	2–4
Figure 2–4: Operation with mouse and keyboard	2–5
Figure 2–5: Display screen configuration	2–6
Figure 2–6: Status display	2–8
Figure 2–7: Pre- and post-trigger regions	2–8
Figure 2–8: Key lock display	2–9
Figure 2–9: Setup display	2–10
Figure 2–10: Examples of menu item display	2–11
Figure 2–11: Menu item types	2–12
Figure 2–12: Numeric setting menu	2–12

Figure 2–13: Changing value with the knob	2–13
Figure 2–14: Changing value with the keypad	2–14
Figure 2–15: Numeric keypad	2–14
Figure 2–16: Changing the step size for the center frequency	2–15
Figure 2–17: Changing the step size for the center frequency	2–15
Figure 2–18: Menu keys	2–17
Figure 2–19: Measurement menu keys	2–18
Figure 2–20: Setting frequency, span, and amplitude	2–20
Figure 2–21: Display menu keys	2–32
Figure 2–22: Display line	2–33
Figure 2–23: Marker display	2–34
Figure 2–24: Utility menu keys	2–37
Figure 2–25: Cable connection	2–44
Figure 2–26: Principal power switch (rear panel)	2–45
Figure 2–27: Power switch (ON/STANDBY)	2–45
Figure 2–28: Initial screen	2–46
Figure 2–29: Frequency, span, and amplitude settings	2–48
Figure 2–30: Menu items for numeric value input	2–49
Figure 2–31: Numeric value entry keypad	2–50
Figure 2–32: Center frequency of 800 MHz, span of 15 MHz	2–50
Figure 2–33: Center frequency of 800 MHz, span of 100 kHz	2–52
Figure 2–34: Setting amplitude	2–53
Figure 2–35: Menu items for numeric value input	2–54
Figure 2–36: Reference level of 10 dBm	2–54
Figure 2–37: Status indicator	2–55
Figure 2–38: Measurement with a single marker	2–58
Figure 2–39: Measurement with the delta marker	2–60
Figure 2–40: Searching for the peak	2–62
Figure 2–41: Comparing a new waveform with an averaged waveform	2–64
Figure 2–42: Comparison display with averaged waveform	2–65
Figure 2–43: Concurrent display of spectrum and spectrogram	2–66
Figure 2–44: Tall display of spectrum and spectrogram	2–67
Figure 2–45: Spectrogram view	2–68
Figure 2–46: Channel power measurement	2–70
Figure 2–47: Channel power measurement (Channel Bandwidth = 40 kHz)	2–71
Figure 2–48: Carrier frequency measurement	2–72
Figure 2–49: MODE keys	2–73

Figure 2–50: IQ level measurement	2–74
Figure 2–51: Analysis range settings	2–76
Figure 2–52: Frame and block	2–76
Figure 2–53: Changing the acquisition length	2–77
Figure 2–54: Single view display	2–78
Figure 2–55: Scale settings	2–79
Figure 3–1: S/A measurement screen	3–2
Figure 3–2: “Flex” grid style	3–3
Figure 3–3: Channel power measurement band power markers	3–6
Figure 3–4: Channel power measurement	3–6
Figure 3–5: ACPR measurement band power markers	3–8
Figure 3–6: Example of ACPR measurement	3–8
Figure 3–7: C/N measurement band power markers	3–10
Figure 3–8: Example of C/N measurement	3–10
Figure 3–9: OBW measurement band power marker	3–12
Figure 3–10: Example of OBW measurement	3–12
Figure 3–11: Carrier frequency measurement	3–14
Figure 3–12: EBW measurement band power markers	3–16
Figure 3–13: EBW measurement	3–16
Figure 3–14: Setting up spurious signal measurement	3–18
Figure 3–15: Example of spurious signal measurement	3–19
Figure 3–16: Spectrum and spectrogram concurrent display	3–20
Figure 3–17: View orientation	3–21
Figure 3–18: Single display	3–21
Figure 3–19: Difference between normal and real-time modes	3–22
Figure 3–20: Real-time mode	3–25
Figure 3–21: Demod mode screen	3–28
Figure 3–22: Analysis range setting in the overview	3–29
Figure 3–23: MARKERS keys	3–30
Figure 3–24: Specifying the range with the marker and the reference cursor	3–31
Figure 3–25: FFT processing range setting on the overview	3–31
Figure 3–26: Changing the overview and subview	3–33
Figure 3–27: One-view display	3–34
Figure 3–28: AM signal measurement	3–37
Figure 3–29: FM signal measurement	3–39
Figure 3–30: PM signal measurement	3–40
Figure 3–31: IQ level measurement	3–41

Figure 3–32: Process flow of a digitally-modulated signal	3–44
Figure 3–33: Constellation analysis	3–47
Figure 3–34: EVM analysis	3–48
Figure 3–35: IQ level/frequency measurement	3–49
Figure 3–36: Symbol table analysis	3–50
Figure 3–37: Eye diagram analysis	3–51
Figure 3–38: Time mode screen	3–54
Figure 3–39: Example of IQ level change measurement	3–57
Figure 3–40: Power variance measurement	3–58
Figure 3–41: Frequency measurement	3–59
Figure 3–42: CCDF calculation process	3–60
Figure 3–43: CCDF measurement	3–62
Figure 3–44: Setting the scale in spectrum view	3–65
Figure 3–45: Scale and format settings in spectrogram view	3–67
Figure 3–46: Setting the scale in time domain view	3–69
Figure 3–47: Setting the scale in CCDF view	3–70
Figure 3–48: Vector and constellation displays	3–71
Figure 3–49: Setting the scale in the EVM view	3–73
Figure 3–50: EVM, magnitude and phase error displays	3–73
Figure 3–51: Constellation view and error vectors in $1/4\pi$ QPSK ...	3–74
Figure 3–52: Symbol table	3–75
Figure 3–53: Example of eye diagram view	3–77
Figure 3–54: Setting frequency and span	3–80
Figure 3–55: Setting the center frequency using MARKER ➡	3–82
Figure 3–56: Relationship between the frequency and span settings .	3–84
Figure 3–57: Vector mode and scalar mode	3–85
Figure 3–58: Setting the amplitude	3–88
Figure 3–59: A/D overflow indicator	3–90
Figure 3–60: Concept of the amplitude correction	3–91
Figure 3–61: Amplitude correction example	3–92
Figure 3–62: Amplitude correction data input	3–95
Figure 3–63: Amplitude offset	3–97
Figure 3–64: Frequency offset	3–97
Figure 3–65: Amplitude correction setup display	3–98
Figure 3–66: FFT and RBW process	3–101
Figure 3–67: Process flow when RBW/FFT = FFT	3–102
Figure 3–68: Generating spurious signals by increasing the number of FFT points	3–103
Figure 3–69: Windowing process of time domain data	3–105

Figure 3-70: Frame cycle	3-111
Figure 3-71: Seamless acquisition	3-111
Figure 3-72: Timing parameters	3-113
Figure 3-73: Trigger level and slope	3-118
Figure 3-74: Trigger position	3-119
Figure 3-75: Acquiring and displaying data by Trigger and Repeat modes	3-119
Figure 3-76: Trigger level vs. Amplitude (reference level = +3 dBm)	3-120
Figure 3-77: Waveforms in time domain and in frequency domain .	3-121
Figure 3-78: IF trigger detection range	3-122
Figure 3-79: Trigger mask	3-123
Figure 3-80: Filling operation for creating a mask	3-125
Figure 3-81: Example mask	3-126
Figure 3-82: Default mask	3-127
Figure 3-83: Changing the position of Point A	3-127
Figure 3-84: Changing the position of Point B	3-128
Figure 3-85: Adding Point C	3-128
Figure 3-86: Trigger point display	3-130
Figure 3-87: Comparison display of Trace 1 and 2	3-131
Figure 3-88: Displaying an averaged waveform	3-135
Figure 3-89: Compared display	3-136
Figure 3-90: Relationships between frame, bin, and pixel	3-139
Figure 3-91: Compression method for displaying the waveform	3-140
Figure 3-92: Measurement with a single marker	3-142
Figure 3-93: Using the delta marker to take measurements	3-143
Figure 3-94: Measurement with the reference cursor	3-144
Figure 3-95: Changing the Trace	3-145
Figure 3-96: Interlock of markers	3-146
Figure 3-97: Functions of the peak search keys	3-147
Figure 3-98: Setting the minimum frequency jump	3-148
Figure 3-99: Horizontal and vertical line	3-150
Figure 3-100: Two horizontal lines	3-150
Figure 3-101: Two horizontal and two vertical lines	3-151
Figure 3-102: Disk drive (side panel)	3-153
Figure 3-103: Save to the preset file (lower right of the screen)	3-155
Figure 3-104: Selecting the folder	3-156
Figure 3-105: Save to File menu	3-157
Figure 3-106: Load from the preset file (lower right of the screen) ..	3-158
Figure 3-107: Load from File menu	3-159

Figure 3–108: Alphanumeric keypad	3–160
Figure 3–109: Data file structure	3–163
Figure 3–110: Adding dummy frames	3–165
Figure 3–111: Data block	3–167
Figure 3–112: Trace file structure	3–171
Figure 3–113: Trace file example	3–171
Figure 3–114: Data block	3–173
Figure 3–115: 10/100BASE–T connector (side panel)	3–175
Figure 3–116: Sharing settings dialog box	3–176
Figure 3–117: USB ports (side panel)	3–177
Figure 3–118: Connecting USB devices	3–178
Figure 3–119: Displaying the Windows 98 accessory menu	3–180
Figure 3–120: USB ports (side panel)	3–182
Figure 3–121: Print command	3–183
Figure 3–122: Save screen to file	3–184
Figure 3–123: Online help for the front panel key	3–186
Figure 3–124: Online user manual	3–187
Figure 3–125: Word search using the keyboard	3–188
Figure 3–126: Displaying versions and options	3–189

List of Tables

Table 1–1: Span and RBW	1–15
Table 2–1: Key functions of the keyboard	2–5
Table 2–2: Status display	2–8
Table 2–3: Span setting range	2–20
Table 2–4: Reference level setting range	2–21
Table 2–5: RF attenuation level setting	2–22
Table 2–6: Mixer level setting	2–22
Table 2–7: Vertical scale setting range	2–22
Table 3–1: Standard menu in the S/A mode	3–1
Table 3–2: Measurement items in the S/A mode	3–4
Table 3–3: Features of the real-time mode	3–23
Table 3–4: Span setting range	3–23
Table 3–5: Standard menu in the Demod mode	3–27
Table 3–6: Analog modulation analysis	3–35
Table 3–7: Digital modulation analysis	3–42
Table 3–8: Communication standard and parameters	3–43
Table 3–9: Time variation measurement	3–56
Table 3–10: Frequency and span setting range	3–83
Table 3–11: Reference level setting range	3–87
Table 3–12: RF attenuation level setting	3–89
Table 3–13: Mixer level setting	3–89
Table 3–14: Vertical units and scale setting	3–89
Table 3–15: Characteristics and usage of FFT windows	3–104
Table 3–16: FFT window and bandpass filter	3–106
Table 3–17: How to acquire a waveform	3–110
Table 3–18: Trigger level setting range	3–117
Table 3–19: Averaging method	3–133
Table 3–20: Number of bins (FFT points: 1024)	3–138
Table 3–21: File save operation	3–155
Table 3–22: Preset file names	3–156
Table 3–23: File load operation	3–158
Table 3–24: Combinations of valid A, P, I and Q	3–168
Table 3–25: Front panel keys for online help	3–186

Table A-1: Frequency	A-1
Table A-2: Spectrum purity	A-2
Table A-3: Noise sideband	A-2
Table A-4: Input	A-4
Table A-5: Amplitude	A-4
Table A-6: Dynamic range	A-5
Table A-7: Spurious response	A-6
Table A-8: Acquisition	A-6
Table A-9: Sampling rate	A-7
Table A-10: Frame time	A-8
Table A-11: Digital demodulation	A-8
Table A-12: Analog demodulation	A-10
Table A-13: RBW (Resolution Bandwidth)	A-11
Table A-14: Trigger	A-12
Table A-15: Measurement function	A-12
Table A-16: Display	A-12
Table A-17: Marker, trace, and display line	A-13
Table A-18: Controller and interface	A-13
Table A-19: Power requirements	A-14
Table A-20: Power connector	A-14
Table A-21: Physical characteristics	A-15
Table A-22: Environmental characteristics	A-15
Table A-23: Certifications and compliances	A-16
Table B-1: Measurement menu	B-2
Table B-2: Display menu	B-4
Table B-3: Utility menu	B-4
Table C-1: External inspection check list	C-1
Table D-1: Power cord identification	D-2
Table D-2: Standard accessories	D-3
Table D-3: Accessories for optional software	D-3
Table D-4: Optional accessories	D-4

General Safety Summary

Review the following safety precautions to avoid injury and prevent damage to this product or any products connected to it. To avoid potential hazards, use this product only as specified.

Only qualified personnel should perform service procedures.

To Avoid Fire or Personal Injury

Use Proper Power Cord. Use only the power cord specified for this product and certified for the country of use.

Connect and Disconnect Properly. Do not connect or disconnect probes or test leads while they are connected to a voltage source.

Ground the Product. This product is grounded through the grounding conductor of the power cord. To avoid electric shock, the grounding conductor must be connected to earth ground. Before making connections to the input or output terminals of the product, ensure that the product is properly grounded.

Observe All Terminal Ratings. To avoid fire or shock hazard, observe all ratings and markings on the product. Consult the product manual for further ratings information before making connections to the product.

Do Not Operate Without Covers. Do not operate this product with covers or panels removed.

Avoid Exposed Circuitry. Do not touch exposed connections and components when power is present.

Do Not Operate With Suspected Failures. If you suspect there is damage to this product, have it inspected by qualified service personnel.

Do Not Operate in Wet/Damp Conditions.

Do Not Operate in an Explosive Atmosphere.

Keep Product Surfaces Clean and Dry.

Provide Proper Ventilation. Refer to the manual's installation instructions for details on installing the product so it has proper ventilation.

Symbols and Terms

Terms in this Manual. These terms may appear in this manual:



WARNING. *Warning statements identify conditions or practices that could result in injury or loss of life.*



CAUTION. *Caution statements identify conditions or practices that could result in damage to this product or other property.*

Terms on the Product. These terms may appear on the product:

DANGER indicates an injury hazard immediately accessible as you read the marking.

WARNING indicates an injury hazard not immediately accessible as you read the marking.

CAUTION indicates a hazard to property including the product.

Symbols on the Product. The following symbols may appear on the product:



Protective Ground
(Earth) Terminal



CAUTION
Refer to Manual

Preface

This is the user manual for the WCA230A and WCA280A Portable Wireless Communication Analyzers. It covers the following information:

- Describes the capabilities of the analyzer and how to install it
- Explains how to operate the analyzer: how to control acquisition of, processing of, and input/output of information
- Lists specifications and accessories of the analyzer

About This Manual

This manual is composed of the following chapters:

- *Getting Started* describes the product overview, architecture, installation, and calibration of the analyzer.
- *Operating Basics* explains the functions of the front, rear, and side panels and menu items of the analyzer, and describes the basic menu operations. This section also provides the tutorials for beginners. It gives step-by-step procedures for measurement using a signal generator.
- *Reference* explains the basic concepts of measurement processes and application-specific operations. It also gives the combined procedures of the front panel keys and menu operations.
- *Appendices* provide additional information including the specifications, accessories, and cleaning information.

First time users should complete the installation as described in *Getting Started*, then go to *Operating Basics* and perform the procedures shown in *Tutorial* beginning on Page 2–43.

The analyzer uses Windows 98 as the operating system. This manual does not describe common usage of Windows 98. Refer to your Windows manuals as necessary.

Related Documents

In addition to this user manual, the following documentation is available for your analyzer. Tektronix part numbers are supplied in *Appendix D: Options and Accessories*.

- *WCA230A and WCA280A Programmer Manual* (standard accessory) contains an alphabetical listing of the programming commands and other information related to controlling the analyzer over the GPIB interface.
- *WCA230A and WCA280A Service Manual* (optional accessory) describes how to verify the characteristics of, adjust, disassemble, assemble, and troubleshoot the analyzer, and contains the information required for repair, including module replacement, and calibration.

When using the optional software, refer to the following manuals:

- *WCA230A and WCA280A Option 22: W-CDMA Downlink Analysis Software User Manual* (071-1475-00) provides operating basics and GPIB programming information for the W-CDMA downlink analysis.
- *WCA230A and WCA280A Option 23: W-CDMA Uplink Analysis Software User Manual* (071-1477-00) provides operating basics and GPIB programming information for the W-CDMA uplink analysis.
- *WCA230A and WCA280A Option 24: GSM/EDGE Analysis Software User Manual* (071-1479-00) provides operating basics and GPIB programming information for the GSM/EDGE analysis.
- *WCA230A and WCA280A Option 25: cdma2000 Analysis Software User Manual* (071-1367-00) provides operating basics and GPIB programming information for the cdma2000 forward and reverse link analysis.
- *WCA230A and WCA280A Option 26: cdma2000 1xEV-DO Analysis Software User Manual* (071-1371-00) provides operating basics and GPIB programming information for the cdma2000 forward and reverse link analysis.

Conventions

This manual uses the following conventions:

- Front-panel button and control labels are printed in the manual in upper case text. For example, SPAN, PEAK, PRINT. If it is part of a procedure, the button or control label is printed in boldface. For example:

Press **SPAN**.

- To easily find buttons on the front panel, the area name label is printed together with the button by concatenating with a colon (:), as in MODE: **DEMOD**, VIEW: **SCALE**, MARKERS: **SELECT**. For example:

Press the MODE: **DEMOD** key.

- Menu and on-screen form titles are printed in the manual in the same case (initial capitals) as they appear on the analyzer screen, such as Span, Source, and Channel Power. If it is part of a procedure, the menu title is shown in boldface. For example:

Press the **Source** side key.

- A list of keys, controls, and/or menu items separated by an arrow symbol (→) indicates the order in which to perform the listed tasks. For example:

Select **RBW/FFT** → **Filter Shape...** → **Gaussian**.

Contacting Tektronix

Phone	1-800-833-9200*
Address	Tektronix, Inc. Department or name (if known) 14200 SW Karl Braun Drive P.O. Box 500 Beaverton, OR 97077 USA
Web site	www.tektronix.com
Sales support	1-800-833-9200, select option 1*
Service support	1-800-833-9200, select option 2*
Technical support	Email: techsupport@tektronix.com 1-800-833-9200, select option 3* 6:00 a.m. – 5:00 p.m. Pacific time

* **This phone number is toll free in North America. After office hours, please leave a voice mail message. Outside North America, contact a Tektronix sales office or distributor; see the Tektronix web site for a list of offices.**

Getting Started

Product Overview

The WCA230A and the WCA280A are portable wireless communication analyzers capable of real-time spectrum analysis and modulated-signal analysis. The analyzers enable transmitter characteristic evaluation required for mobile communication systems. Large capacity memory that collects W-CDMA data up to 2.5 seconds is standard, ensuring even accurate collection and analysis of super frame signals defined in the 3GPP standard.

Features

- Measurement frequency range:
DC to 3 GHz for WCA230A, DC to 8 GHz for WCA280A
- Measurement span: 100 Hz to 3 GHz
Vector span: 15 MHz
- Memory depth: 64 MB (Standard), 256 MB (Option 02)
- Real-time analysis
- Spectrum analysis: power, ACPR, C/N, OBW, EBW, spurious
- Digital modulation analysis: constellation, eye diagram, symbol table, EVM
- Analog modulation analysis: AM, PM, FM
- Time characteristic analysis
- CCDF measurement
- Various displays of analysis results:
 - Spectrum display (frequency versus power)
 - Spectrogram display (frequency versus time versus power)
 - Time characteristic analysis display (IS-95 standard)
 - Analog demodulation display
(time versus modulation factor, phase, or frequency)
 - Digital demodulation display
(constellation, eye diagram, symbol table, EVM)
- 8.4 inch TFT color display and sturdy cabinet

Application

The WCA230A and the WCA280A can perform real-time analysis for the following purposes:

- Research and development of second and third generation communication instruments: 3GPP, W-CDMA, GSM, IS-95, T-53, PDC
- Research and development of Bluetooth communication instruments
- Digital modulation analysis
- Analog modulation analysis
- Power measurement: power, noise, ACP, C/N, occupied bandwidth
- CCDF measurement
- Variation analysis of PLL frequency:
 - Jitter in reference oscillator circuits of mobile phones
 - Localization of radio equipment
 - Hard disk readout jitter
- Analysis of momentary noise: mixed noise measurement, EMI measurement
- Multi-path measurement: measurement of electric wave environment
- Electric wave interference: radar interference
- Electric wave analysis: analysis of electric waves from foreign countries

Difference between WCA230A and WCA280A

The WCA230A and the WCA280A have the same functions except for their measurement frequency ranges:

WCA230A DC to 3 GHz
WCA280A DC to 8 GHz

Descriptions in this manual apply to both the WCA230A and the WCA280A unless otherwise noted.

Real-Time Analysis

This section explains real-time analysis with the comparison of conventional swept spectrum analyzer and real-time spectrum analyzer.

Conventional Swept Spectrum Analyzer

Figure 1–1 is a block diagram of the conventional swept spectrum analyzer. There are two RF input signals in this example. The RF signal is converted to IF (intermediate frequency) by the swept local oscillator. IF output goes through a bandpass filter, where resolution of the spectrum analyzer is defined.

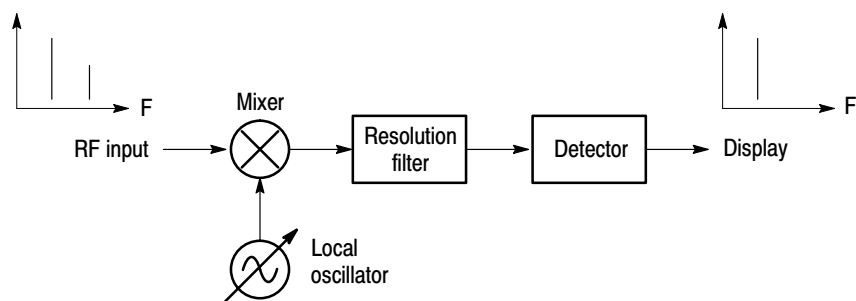

Figure 1–1: Concept of the swept spectrum analyzer

The filter is swept from F_{start} to F_{stop} . See Figure 1–2. Only signals within the filter bandwidth are observed at one point in time. Signal A is detected first and then signal B is detected and displayed.

NOTE. An intermittent signal, such as a burst phenomenon, will not be detected unless it is present at the exact moment that the filter is being swept past it.

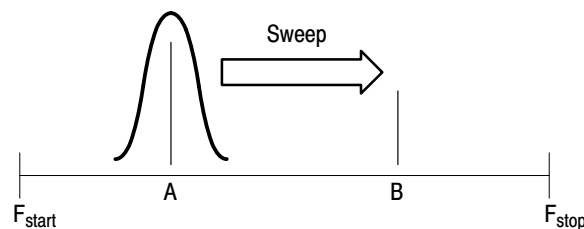

Figure 1–2: Sweep of resolution filter

Real-Time Spectrum Analyzer

The real-time spectrum analyzer is conceptually equipped with a series of bandpass filters as shown in Figure 1-3. Signals passing through those filters are concurrently observed and recorded continuously. Signals A and B are concurrently acquired and displayed as shown in Figure 1-4.

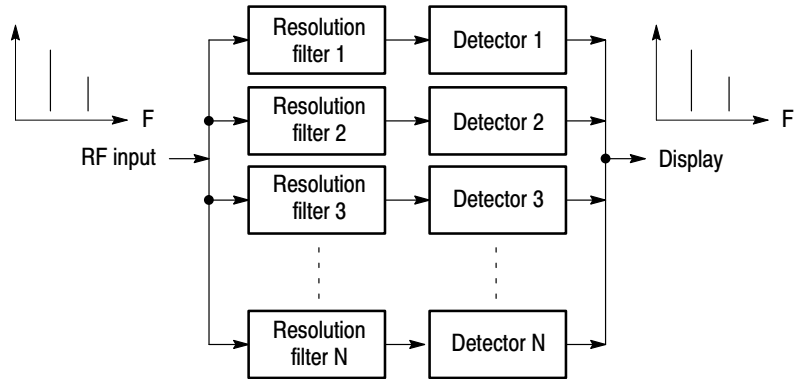

Figure 1-3: Concept of the real-time spectrum analyzer

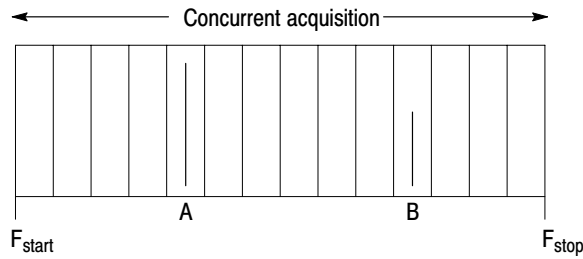

Figure 1-4: Concurrent acquisition

The method used to concurrently acquire signals in a certain frequency range is not bandpass filters, but FFT (Fast Fourier Transformation). The WCA230A or WCA280A first acquires a series of frames of data in the time domain, as shown in Figure 1–5, and then performs the FFT process for each frame. This method enables continuous analysis of spectra and ensures the capture of real-time phenomenon such as burst signals in digital mobile communication. The WCA230A and the WCA280A are equipped with a 51.2 MHz A/D converter to analyze the spectrum by single scanning for spans up to 15 MHz.

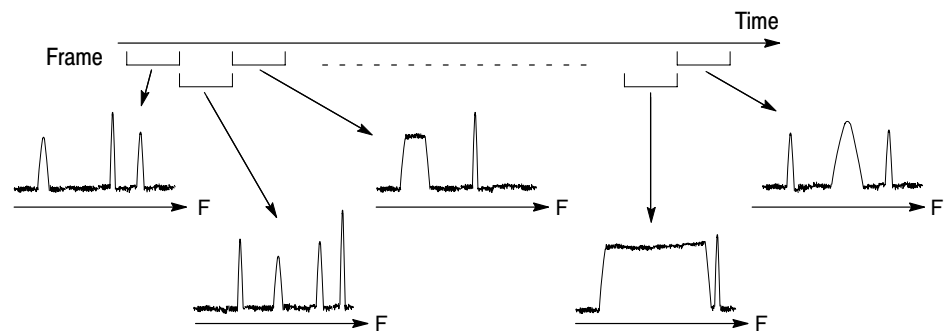

Figure 1–5: Frame acquisition

Architecture

Figure 1-6 shows the block diagram of the signal processing system.

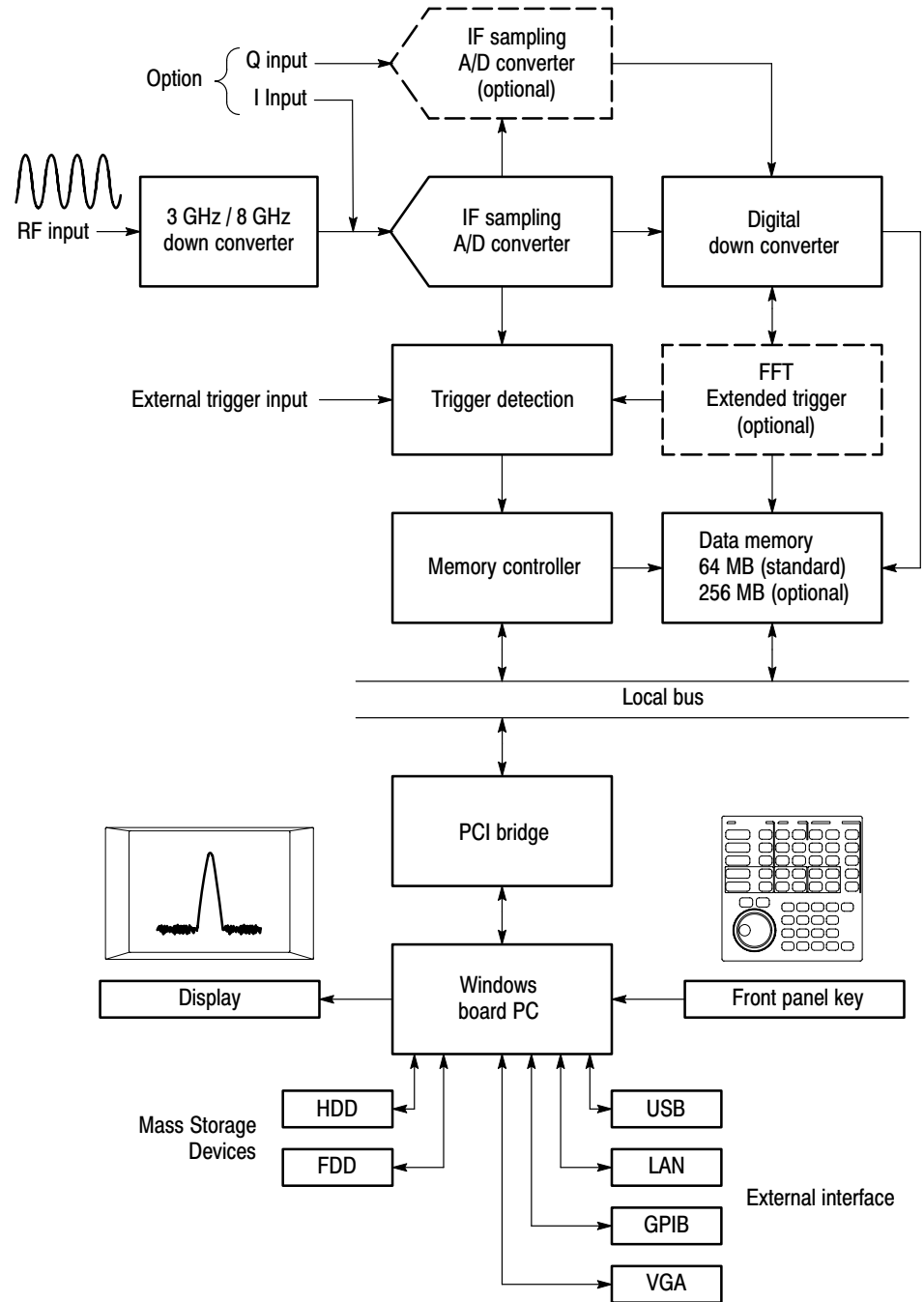

Figure 1-6: Block diagram

**3 GHz / 8 GHz
Down Converter**

Converts the RF signal, input through the front-panel INPUT connector, into a 20 MHz IF signal. This converter processes signals up to 3 GHz for WCA230A and 8 GHz for WCA280A by IF conversions in three stages. A 10 MHz oscillator provides a high-accuracy reference for all stages of IF conversion. The converter also adjusts signals for A/D conversion using a low-noise amplifier, fine-tuning attenuator, and anti-alias filter. The output signal from the down converter is sent to the IF sampling A/D converter described below.

IF Sampling A/D Converter

The IF analog output from the down converter enters the A/D converter through the fine-tuning attenuator, low-noise amplifier, and anti-alias filter, to be converted into a digital signal. The sampling rate of the A/D converter is 51.2 MHz with a resolution of 14 bits.

Digital Down Converter

The digital down converter splits the real signal from the A/D converter into complex (I and Q) components and limits the frequency span of the resulting signal.

With Option 03, you can enter I and Q signals at this point in the block diagram.

The down converter performs span and center frequency fine-tuning. This converter consists of two primary stages. In the baseband, the first stage converts a 0 to 15 MHz real signal into a complex signal of ± 7.5 MHz. The second stage converts frequency to set any center frequency.

A decimating filter between stages changes the span by effectively reducing the sampling rate. A 503 tap FIR filter and four stage comb filter allows extremely accurate filtering with minimal spurious emissions.

The data streams from the digital down converter are then divided into frames and saved in data memory.

**FFT/Extended Trigger
(Optional)**

Option 02 provides a real-time digital trigger function that monitors the frequency spectrum for the occurrence of specific events. A trigger mask is used to set conditions for trigger.

The FFT processor performs high-speed calculations to create extended trigger signals. The FFT processor performs 1024-point complex FFT at high speed to create extended trigger signals. The FFT processor consists of an input buffer, FFT calculation DSP, output buffer, and timing control circuit. Performing a 1024-point complex FFT at 12,500 times per second allows the trigger to operate in real time in spans up to 15 MHz.

Because the trigger comparator is continuously operating at the maximum rate, no events will be missed. The pre-trigger and post-trigger positions can be set as needed; events before and after the trigger event can be measured.

Data Memory

A high-speed 64 MB standard SDRAM stores spectrum data. It is expanded to 256 MB with Option 02. For each data point, I and Q data use 2 bytes. This memory can store 16,000 frames for 1 waveform = 1024 points of analysis, and 64,000 frames for Option 02. For example, W-CDMA communication data can be captured for up to 2.5 seconds on standard and 10 seconds on Option 02. The memory is accessed from the system controller via the ISA/PCI bridge.

Windows Board PC

The system controller board has an Intel Pentium III CPU. It runs on Windows 98, and controls menu operation from the front panel keys. It is equipped with a 10 GB hard disk and 3.5 inch disk drive to store data and settings. Waveforms, menus, and measurement results are shown on the color display, which uses an 8.4 inch XGA TFT-LCD module.

The standard analyzer has the following external interfaces:

- USB (for mouse, keyboard, and/or printer)
- LAN (Ethernet 10/100BASE-T)
- GPIB
- VGA (for an external monitor)

Installation

This section describes how to install this instrument. The topics are organized as follows:

- Unpacking to check contents
- Applying the power
- Setting up the stand
- Functional check
- Powering off the analyzer
- Restart
- Backing up the user file

Before starting installation, you should become familiar with the *General Safety Summary* on page xiii.

Unpacking to Check Contents

1. This product is packed in a cardboard box for delivery. Before opening the box, make sure that there is no damage on the surface.
2. Open the box, check that the product has no damage and that all the standard accessories are found inside. For a list of accessories, refer to *Standard Accessories* on page D-3. If you find any damaged or missing components, contact your local Tektronix representative.
3. It is recommended to keep the box and packing materials. You may need them to send this product to Tektronix for calibration or repair.



CAUTION. *The analyzer has exhaust fans on the side panel. Leave a space of at least 5 cm (2 in) on both sides for proper air circulation.*

Applying Power

Power on the analyzer using the following procedure:

AC Power Requirements

The analyzer operates from an AC line frequency of 47–63 Hz, over the range of 90–250 Volts, without the need for configuration, except the power cord. Refer to page D–2 for the power cord options.

The maximum power consumption is 350 W. Refer to *Appendix A, Specifications*, for additional information on power and environmental requirements.



CAUTION. Use only power cords that are approved for the country of use. Using non-approved power cords could result in fire or shock hazard.

Connecting the Power Cord

1. Plug the power cord into the AC input on the rear panel.

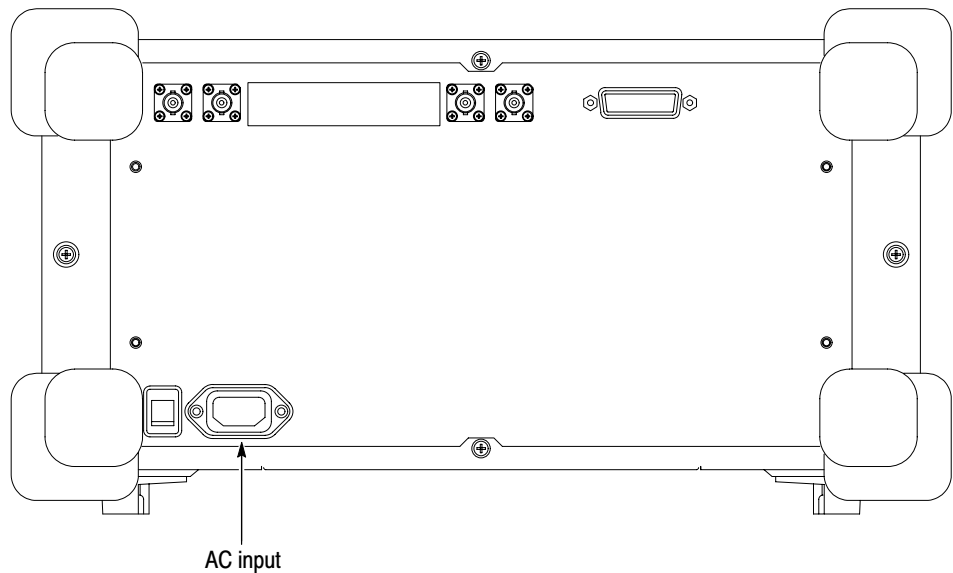
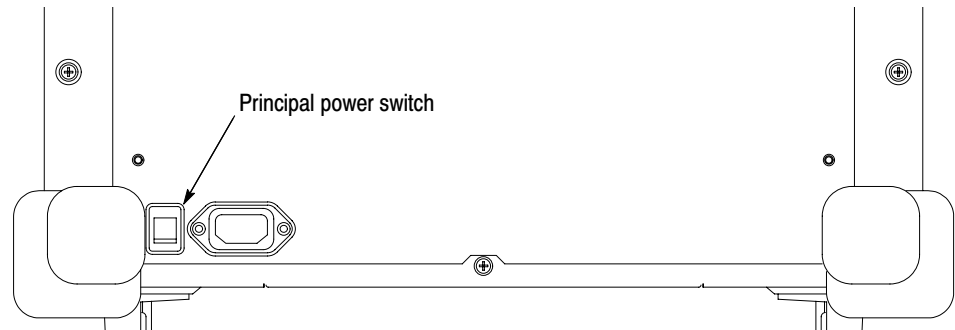

Figure 1-7: AC Input (rear panel)

2. Connect the plug of the power cord to a properly grounded outlet.

Turning on the Analyzer

1. Turn on the principal power switch on the rear panel.

**Figure 1-8: Principal power switch (rear panel)**

When you turn on the principal power switch, a voltage is applied to the analyzer standby circuit. Make sure the LED next to the power switch on the front panel lights up in orange.

2. Turn on the power switch (**ON/STANDBY**) on the lower left of the front panel. The LED next to the power switch changes to green.

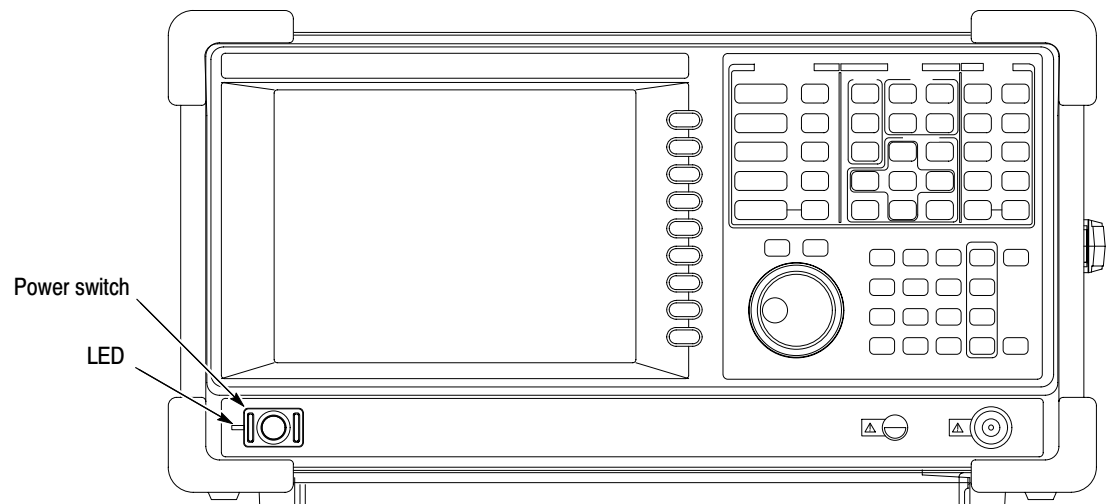
**Figure 1-9: Front panel power switch (ON/STANDBY switch)**

When you turn on the analyzer, Windows 98 boots up. After several minutes, the analyzer application starts up.

The initial screen appears as shown in Figure 1-10. The displayed spectrum represents the noise floor of the analyzer.

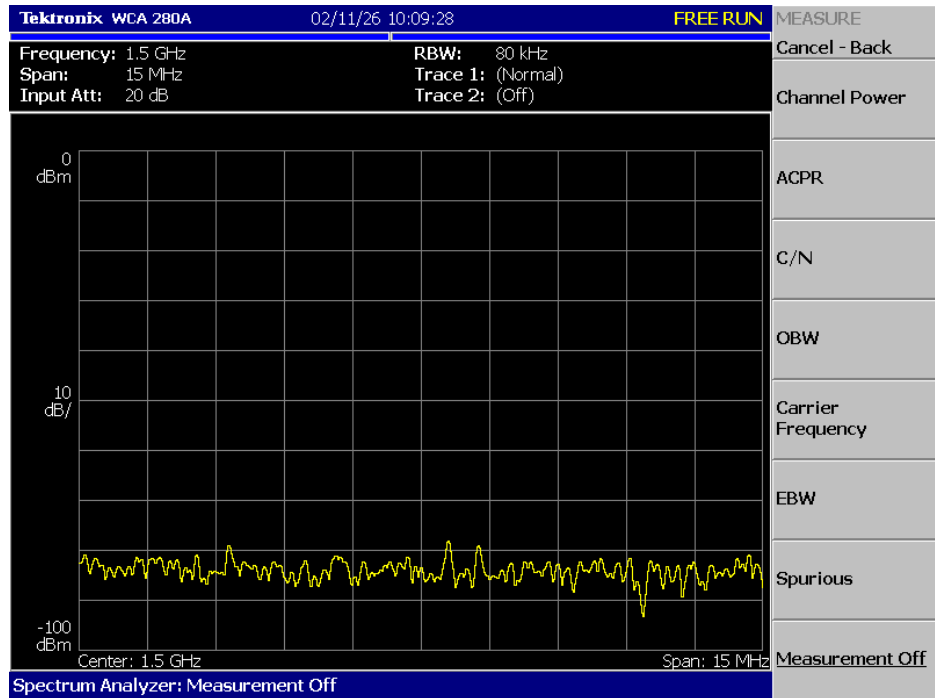

Figure 1-10: Initial screen

If “UNCAL” is displayed on top of the screen, run the gain calibration routine (refer to *Gain Calibration* on page 1-21).



CAUTION. *Never apply signals with a combined amplitude greater than +30 dBm to the RF INPUT connector. If you exceed this input rating, you can permanently damage the analyzer. (The RF INPUT connector is shown in Figure 1-11.)*

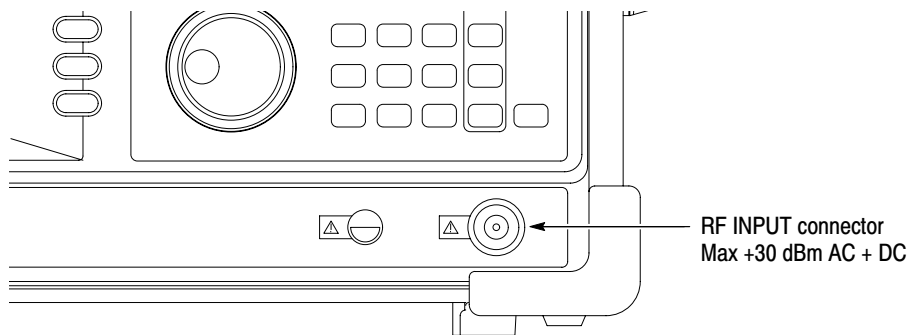

Figure 1-11: RF INPUT connector

Setting Up the Stand

To set up the stand, place the analyzer on a table. Lift the front of the analyzer and pull out the stand until it is perpendicular to the analyzer.

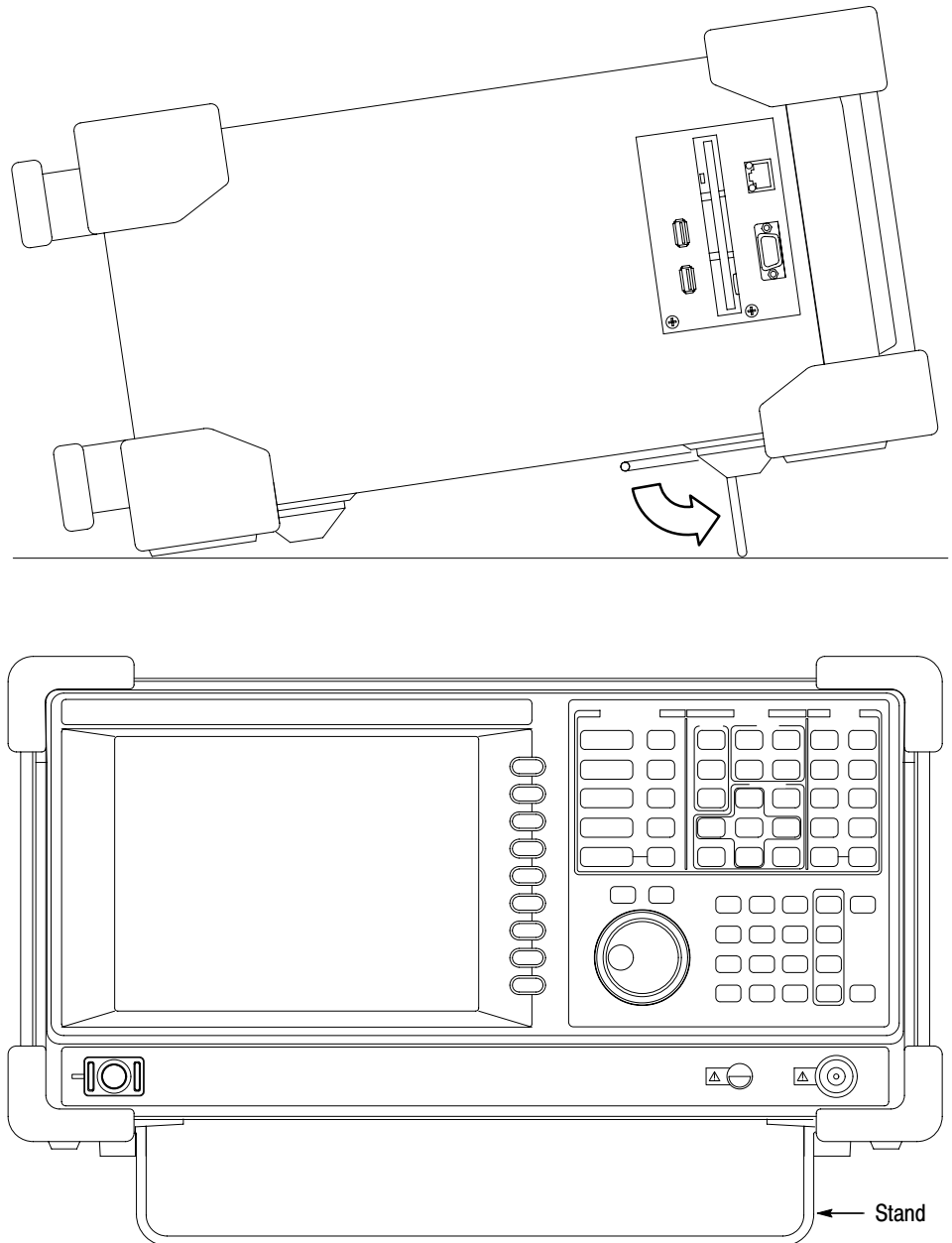

Figure 1-12: Setting up the stand

Functional Check

The analyzer has a built-in calibration signal source with frequency of 50 MHz and amplitude of approximately -20 dBm. Using this source, perform this quick functional check to verify that your instrument is operating correctly.

1. Turn on the analyzer.
2. Display the spectrum of the calibration signal:
 - a. Press the **S/A** key on the front panel and then press the **Spectrum Analyzer** side key.
 - b. Press the **PRESET** key on the front panel to reset the analyzer.
 - c. Press the **INPUT** key on the front panel.
 - d. Press the **Signal Input Port...** side key to select **Cal**.

The spectrum of the calibration signal appears.

- e. Check that “INPUT: CAL” and “FREE RUN” are displayed in the status indicator at the upper right of the screen (see Figure 1–13).

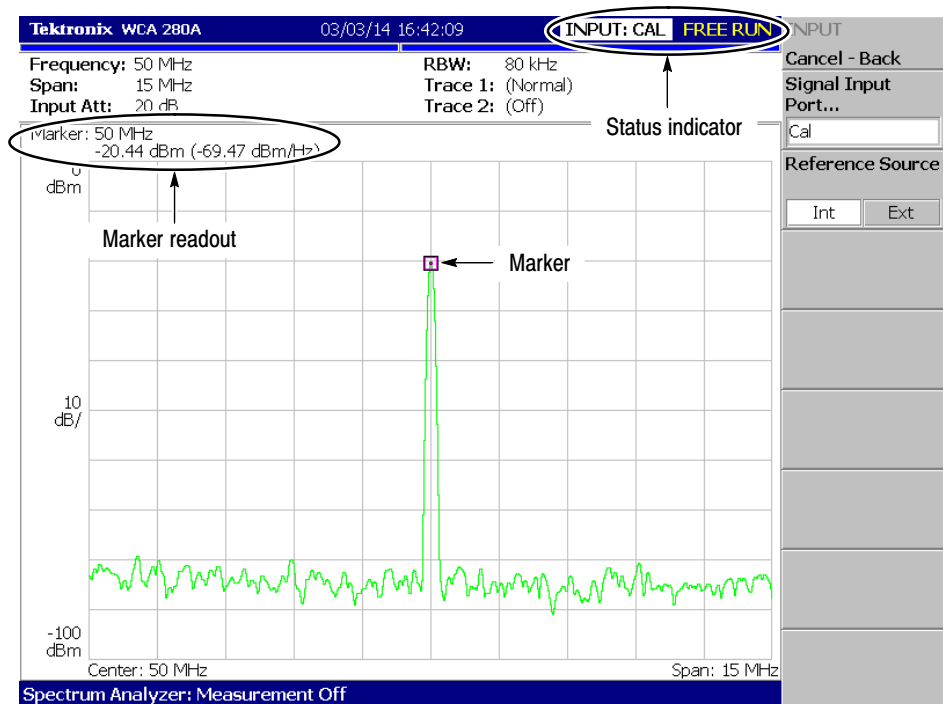

Figure 1–13: Spectrum of the calibration signal (50 MHz, about -20 dBm)

3. Check the center frequency and peak amplitude using the marker:
 - a. Press the **PEAK** key on the front panel to place the marker on the peak (see Figure 1–13).
 - b. Check the marker readouts on screen. The frequency should be 50 MHz and the amplitude should be approximately –20 dBm.
 - c. Press the **MARKER SETUP** key on the front panel and then the **Markers** side key to select Off. Check that the marker disappears.
4. Check the RBW (Resolution Bandwidth) while changing the span setting.
 - a. Press the **SPAN** key on the front panel.
 - b. Confirm that the span is 15 MHz and the RBW is 80 kHz in the setup display on the upper part of the screen (see Figure 1–14).

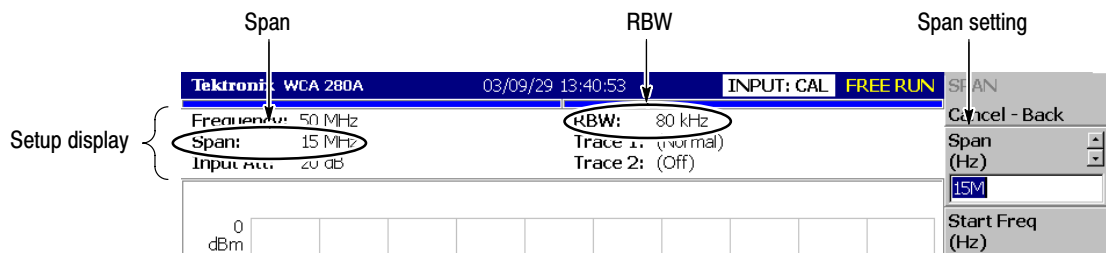

Figure 1–14: Setup display

- c. Using the general purpose knob, change the span setting as listed in Table 1–1 and check that the RBW is displayed correctly.

Table 1–1: Span and RBW

Span	RBW
15 MHz	80 kHz
5 MHz	20 kHz
100 kHz	500 Hz
1 kHz	20 Hz

- d. Using the numeric keypad, set the span back to 15 MHz. (Press **1** → **5** → **MHz**, in that order, on the keypad.)

5. Check the reference level:
 - a. Press the **AMPLITUDE** key on the front panel.
 - b. Make sure that the reference level is set to 0 dBm with the **Ref Level** side key. Check that 0 dBm is displayed on the upper left side of the graticule (see Figure 1–15).
 - c. Use the general purpose knob to set the reference level to –30 dBm.
 - d. Confirm that A/D OVERFLOW is indicated in the red box at the top center of the screen. Make sure that –30 dBm is displayed on the upper left side of the graticule and that the spectrum waveform is distorted as shown in Figure 1–15.

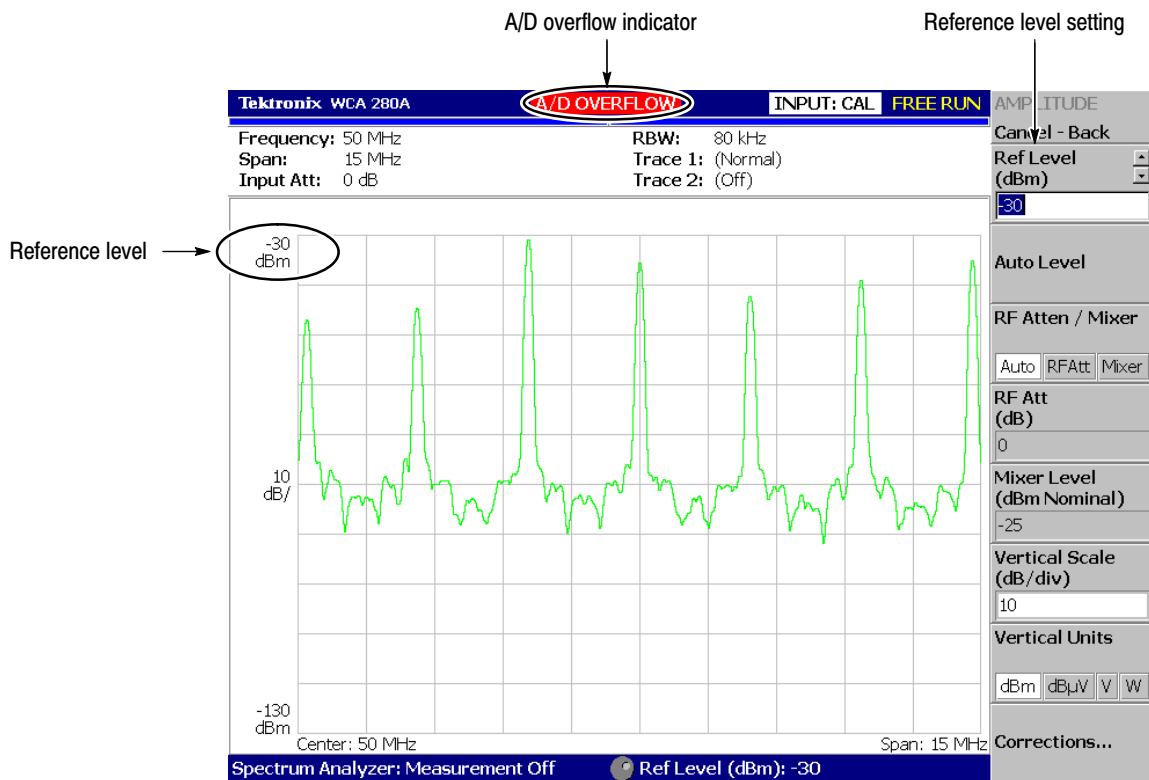

Figure 1–15: Reference level setting and A/D overflow indicator

- e. Using the numeric keypad, set the reference level back to 0 dBm. (Press **0** → **ENTER**, in that order, on the keypad.)

6. Check the spectrogram display:
 - a. Press the **S/A** key on the front panel.
 - b. Press the **S/A with Spectrogram** side key. Check that the spectrogram is displayed on the lower side of the screen (see Figure 1–16).
 - c. Press the **RUN/STOP** key on the front panel to stop data acquisition. Confirm that the trace display freezes and **PAUSE** is displayed in the status indicator at the top right of the screen.

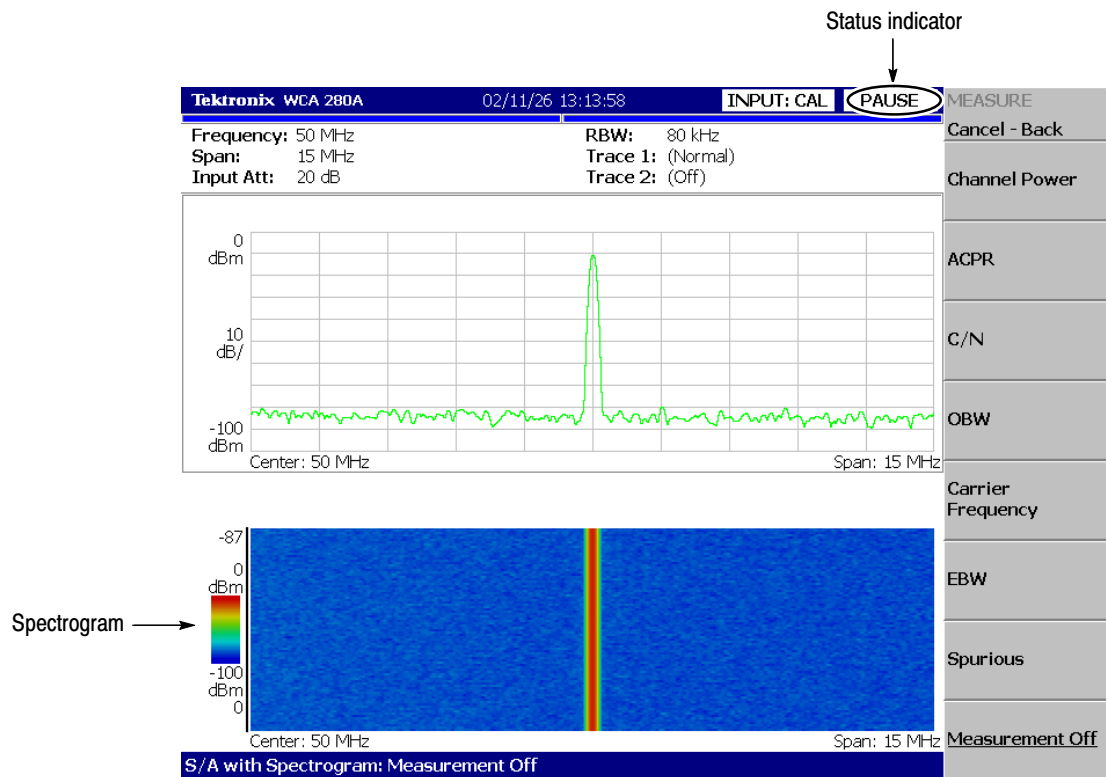

Figure 1–16: Spectrogram display

Powering Off the Analyzer

Turn off the power switch on the front panel.



CAUTION. *When you power on or off the analyzer, you must use the front-panel power switch. Failure to do so may cause the operating system to shut down improperly.*

When you power on the analyzer again, wait at least 10 seconds after the last power off.

When you press the front-panel ON/STANDBY switch, the analyzer starts a shutdown process (including a Windows shutdown) to preserve settings and then power off. The LED next to the power switch changes to orange. Avoid using the rear-panel power switch or disconnecting the power cord to power off the analyzer.

To completely remove power to the analyzer, perform the shutdown just described, and then set the power switch on the rear panel to off.

NOTE. *Turning off the front-panel power switch does not shut down the principal power supply completely. To turn off the principal power supply, press the principal power switch on the rear panel. Turning off the principal power switch turns off the front-panel LED. When you do not use the analyzer for a long time or in case of emergency, you should unplug the power cord.*

Restart

When the analyzer operates abnormally, use the following procedure to turn the analyzer off and on again.

NOTE. *When the analyzer operates abnormally, it will not be shut down by turning off the front-panel power switch alone.*

1. Make sure that the front-panel power switch is in the turned-off position.
2. Turn off the principal power switch on the rear panel.
3. Wait at least 10 seconds and then turn on the principal power switch again.
4. Turn on the front-panel power switch.

When Scan Disk Appears

If the analyzer was not shut down properly, Windows Scan Disk may run when you turn on the analyzer. When the Scan Disk screen appears, wait until the Scan Disk is completed. If an error is detected, refer to the Windows manual for treatment. For more information on accessing Windows on the analyzer, refer to *Using Windows 98* on page 3–179.

When the Display Brightness Is Not Even

It is a characteristic of the LCD (Liquid Crystal Display) panel to sometimes have uneven brightness, dead pixels (dots that never turn on) or stuck pixels (dots that always stay on). This is neither a malfunction nor a defect, and not a cause for repair or exchange.

Backing Up User Files

You should back up your user files on a regular basis as an insurance against system failures. The Back Up tool is located in the System Tool folder in the Accessory folder of Windows. Start this tool to select the files and folders to back up. For more information, use Windows online help. For more information about access to Windows on the analyzer, refer to *Using Windows 98* on page 3-179.

The following files should be backed up more frequently:

- Status files (*.sta)
- Data files (*.iqt)
- Trace files (*.trc)
- Correction files (*.cor)

Refer to page 3-153 for details on file operations.

Using LAN

The analyzer is equipped with LAN Ethernet interface as standard, allowing you to save data in peripheral devices such as other PCs, hard disks, and MO via network. Refer to page 3-175 for details on connecting to LAN.

About Installation of Other Applications

The analyzer incorporates Windows 98 as the operating system. Some combinations of internal measurement applications and external applications may cause deterioration in the basic performance or conflicts between these applications.

It is not recommended that you install other applications, including Microsoft Word, Excel, and Outlook, on the analyzer. If you install an external application, you do so at your own risk, keeping in mind that it may lower the performance of the analyzer.

Calibration

Perform these routines to optimize the analyzer performance:

- Gain calibration
- Center offset calibration
- DC offset calibration
- Display brightness adjustment

Each item is explained in this section.

Gain Calibration

The gain calibration calibrates the analyzer's amplifier gain using the internal signal generator. Run this internal calibration routine as required when you boot the analyzer or when UNCAL (uncalibrated) is displayed during operation.

Allow the analyzer to warm up for 20 minutes before you begin the calibration. The warm-up period allows electrical performance of the analyzer to stabilize.

During normal operation, when the ambient temperature changes by more than $\pm 5\text{ }^{\circ}\text{C}$ from the temperature at the last calibration, UNCAL is displayed in the yellow box at the top of the screen (see Figure 1–17). If this happens, run the gain calibration

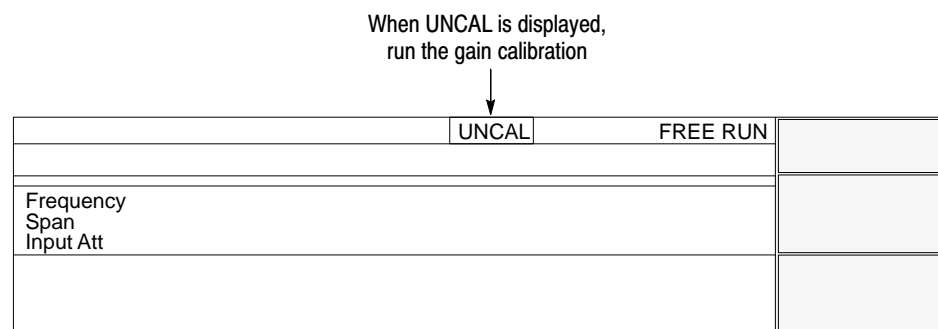

Figure 1–17: UNCAL display

To run the gain calibration, do the following:

NOTE. When you run the gain calibration during signal acquisition, the calibration begins after the acquisition is completed.

1. Press the **CAL** key on the front panel (see Figure 1–18).
2. Press the **Calibrate Gain** side key.

The calibration runs. It takes several seconds to complete the process.

When you want to perform the gain, center offset, and DC offset calibration together, press the **Calibrate All** side key.

3. **Auto Calibration** defaults to **Yes**, which means that the calibration will run automatically any time the analyzer gain drifts to an uncal state. If you run the calibration manually, press the **Auto Calibration** side key to select **No**.

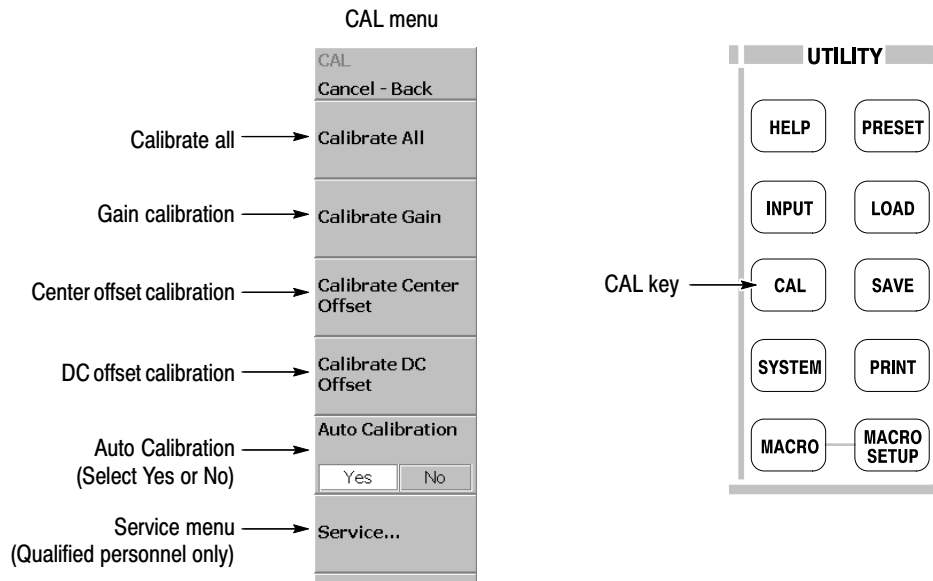

Figure 1–18: Calibration menu

Center Offset Calibration

When you display a spectrum and no input signal is present, a spurious emission at the center frequency may appear regardless of frequency settings. The center offset calibration cancels those spurious emissions. If the spurious emission is too obvious when you narrow the span, run the calibration.

NOTE. *Option 03 only. When you input I and Q signals from the rear panel connectors, set the IQ input signal level to zero externally.*

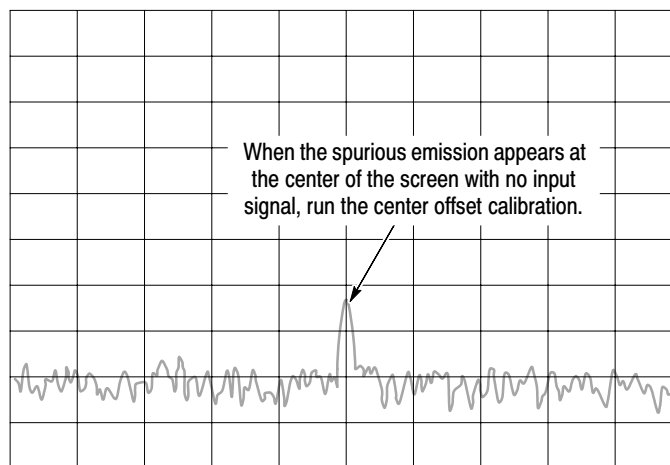

Figure 1-19: Center offset

1. Press the **CAL** key on the front panel (see Figure 1-18).
2. Press the **Calibrate Center Offset** side key.

The calibration runs. It takes several seconds to complete the process.

When you want to perform the gain, center offset, and DC offset calibration together, press the **Calibrate All** side key.

NOTE. *When Auto Calibration is Yes (see Figure 1-18), the center offset calibration runs automatically as analyzer settings change.*

DC Offset Calibration

The DC offset calibration cancels DC offset that appears at 0 Hz in the baseband. When you change the amplitude setting and the DC offset is too obvious, run the DC offset calibration.

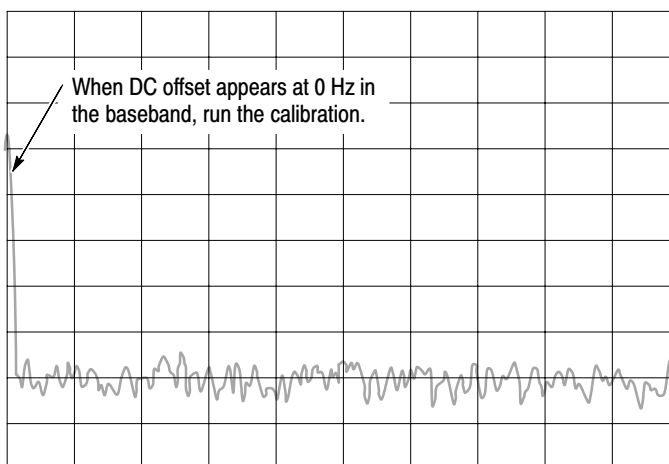

Figure 1-20: DC offset

1. Press the **CAL** key on the front panel (see Figure 1-18).
2. Press the **Calibrate DC Offset** side key.

The calibration runs. It takes several seconds to complete the process.

When you want to perform the gain, center offset, and DC offset calibration together, press the **Calibrate All** side key.

Display Brightness Adjustment

Adjust the brightness of the display according to your environment.

1. Press the **SYSTEM** key on the front panel (see Figure 1–21).

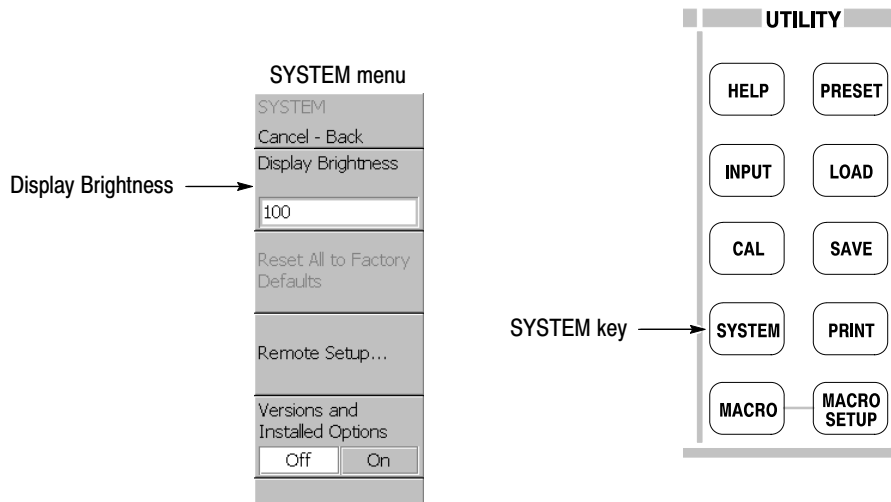

Figure 1-21: System menu

2. Press the **Display Brightness** side key.
3. Turn the general purpose knob to adjust the brightness. The setting range is 0 to 100.

Confirming Performance

The electrical characteristics described in *Appendix A: Specifications* can be checked only by our service personnel. If you need any service, contact your local Tektronix representative.

Operating Basics

Functional Overview

This section describes the controls, connectors, display, and menu operation.

Interface Maps

Controls and Connectors

Figures 2-1 through 2-3 on the following pages show the controls and connectors on the front, the side, and the rear panels.

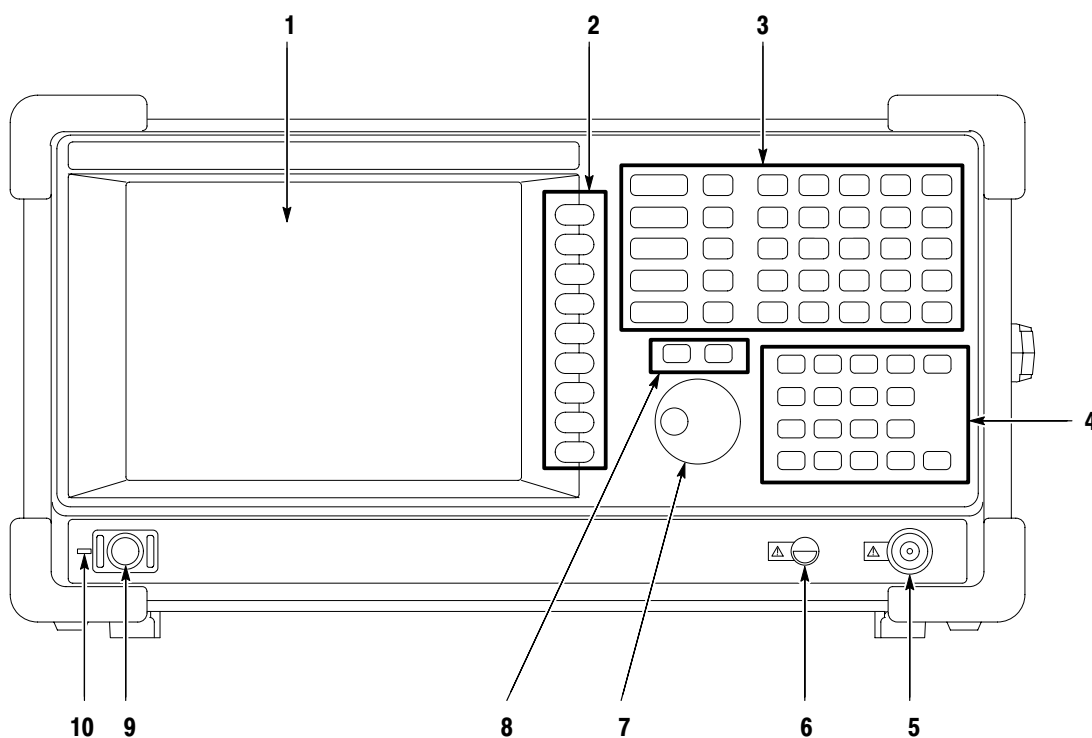

Figure 2-1: Front panel

1. **Display.** Size: 21.3 cm (8.4 inch)
Resolution: 800 X 600 dots
Color: 256 colors maximum
2. **Side Keys.** Select menu items associated with menu keys.
3. **Menu keys.** Select menus. Refer to page 2-17 for details on menus.

4. **Keypad.** Enters alpha and numeric characters. Details are on page 2–12 (for entering numbers) and page 3–108 (for entering other characters).
5. **RF input connector.** Connects an input signal. N-type connector, Input impedance: 50Ω. Maximum capacity of non-breakdown input: 30 dBm.
6. **Preamplifier power source.** Provides power source for a preamplifier (optional accessory). Refer to page A–14 for specifications.
7. **General purpose knob.** Changes a value.
8. **Up/Down keys.** Increase or decrease a value.
9. **Power switch (ON/STANDBY).** Refer to page 1–10 for a power on procedure.
10. **LED.** Green on operating, orange on standby.



CAUTION. Applying a signal of more than +30dBm may damage the instrument.

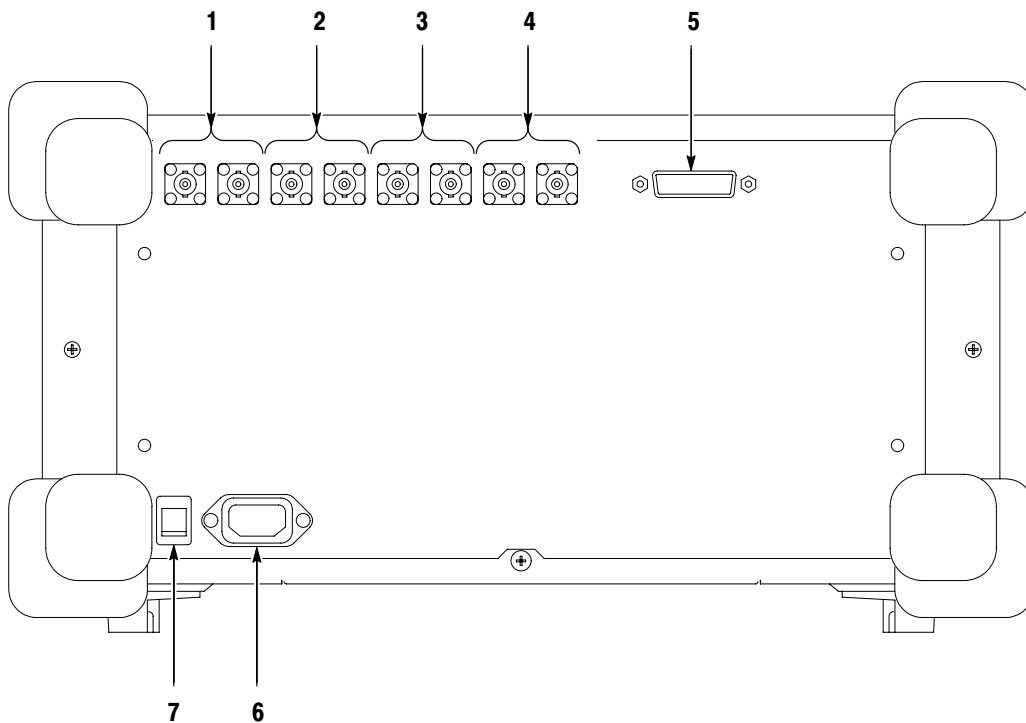

Figure 2-2: Rear panel

1. **REF IN/OUT connector.** 50 Ω BNC connector for reference signal input/output. Refer to page A-14 for specifications.
2. **I+/I- INPUT connector (Option 03 only).** 50 Ω BNC connector for I signal differential input. When using one connector as a single-ended input, terminate the other end in 50 Ω .
3. **Q+/Q- INPUT connector (Option 03 only).** 50 Ω BNC connector for Q signal differential input. When using one connector as a single-ended input, terminate the other end in 50 Ω .
4. **TRIG IN/OUT connector.** 50 Ω BNC connector for trigger signal input/output. Refer to page A-12 for specifications.
5. **GPIB connector.** Used to control the analyzer from an external controller. Refer to the *WCA230A and WCA280A Programmer Manual* for GPIB control.
6. **AC input.** Connect AC power cable.
7. **PRINCIPAL POWER SWITCH.** When this switch is on, the internal standby circuit is energized. Refer to page 1-10 for a power on procedure.

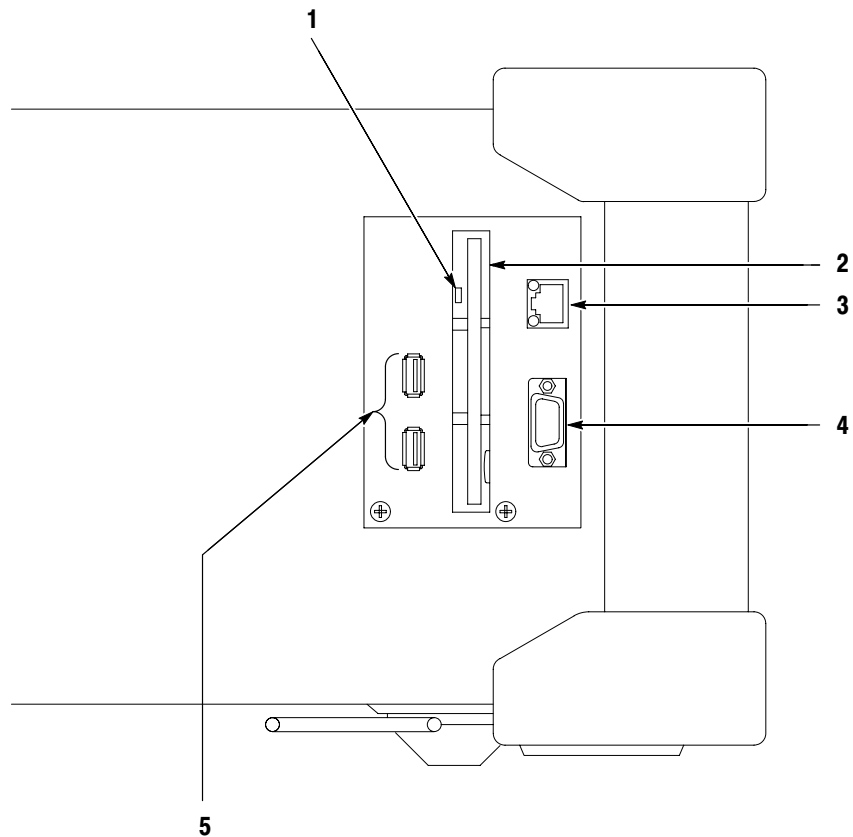

Figure 2-3: Side panel

1. Indicator.



CAUTION. When this indicator is lit, you must not remove the disk from the disk drive. If you do so, the data stored on the medium may be destroyed or an error may occur.

- 2. Disk drive.** Saves and loads data and settings. A 3.5-inch 2HD (1.44MB) or 2DD (720KB) disk formatted for MS-DOS can be used.
- 3. LAN Ethernet connector.** 10/100BASE-T connector. Connects this instrument to a network. Refer to page 3-175 for connection information.
- 4. VGA output connector.** Sends the display of this instrument to another monitor. 15 pin D-sub connector (female)
- 5. USB connector.** Connect a mouse, a keyboard and a printer that meets USB specifications. Refer to page 3-177 for connection information.

Using a Mouse and Keyboard

You can operate the analyzer using the standard accessory mouse and keyboard instead of the side keys and the front panel keypad (see Figure 2–4 and Table 2–1). For information about connecting the mouse and keyboard, refer to *Connecting USB Devices* on page 3–177.

The mouse and keyboard operations are as follows:

- Click the menu item instead of pressing the side keys.
- If the menu item has arrow buttons, click them to select the value.

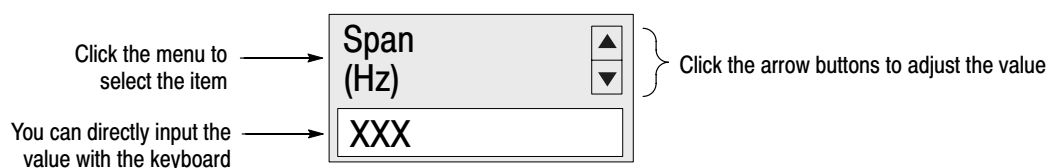

Figure 2–4: Operation with mouse and keyboard

Table 2–1: Key functions of the keyboard

Key	Purpose	Function
Numeric keys	Numeric input	Enter a numeric value in a numeric input field.
Left/Right arrow keys	Caret move	Moves the caret in an alpha or numeric input field.
Home	Caret move	Moves the caret to the beginning of an input field.
End	Caret move	Moves the caret to the end of an input field.
Backspace	Alphanumeric input	Deletes the character before the caret.
Delete	Alphanumeric input	Deletes the character after the caret.
ESC	Alphanumeric input	Aborts a numeric entry and restores the original value.
ENTER	Alphanumeric input	Accepts a value in the input field.
K or k key	Alphanumeric input	Kilo (10^3). Press ENTER to complete entry of the value.
M key	Alphanumeric input	Mega (10^6). Press ENTER to complete entry of the value.
G or g key	Alphanumeric input	Giga (10^9). Press ENTER to complete entry of the value.
m key	Alphanumeric input	milli (10^{-3}). Press ENTER to complete entry of the value.
U or u key	Alphanumeric input	micro (10^{-6}). Press ENTER to complete entry of the value.
N or n key	Alphanumeric input	nano (10^{-9}). Press ENTER to complete entry of the value.

Display Screen Figure 2–5 shows the elements of the display screen.

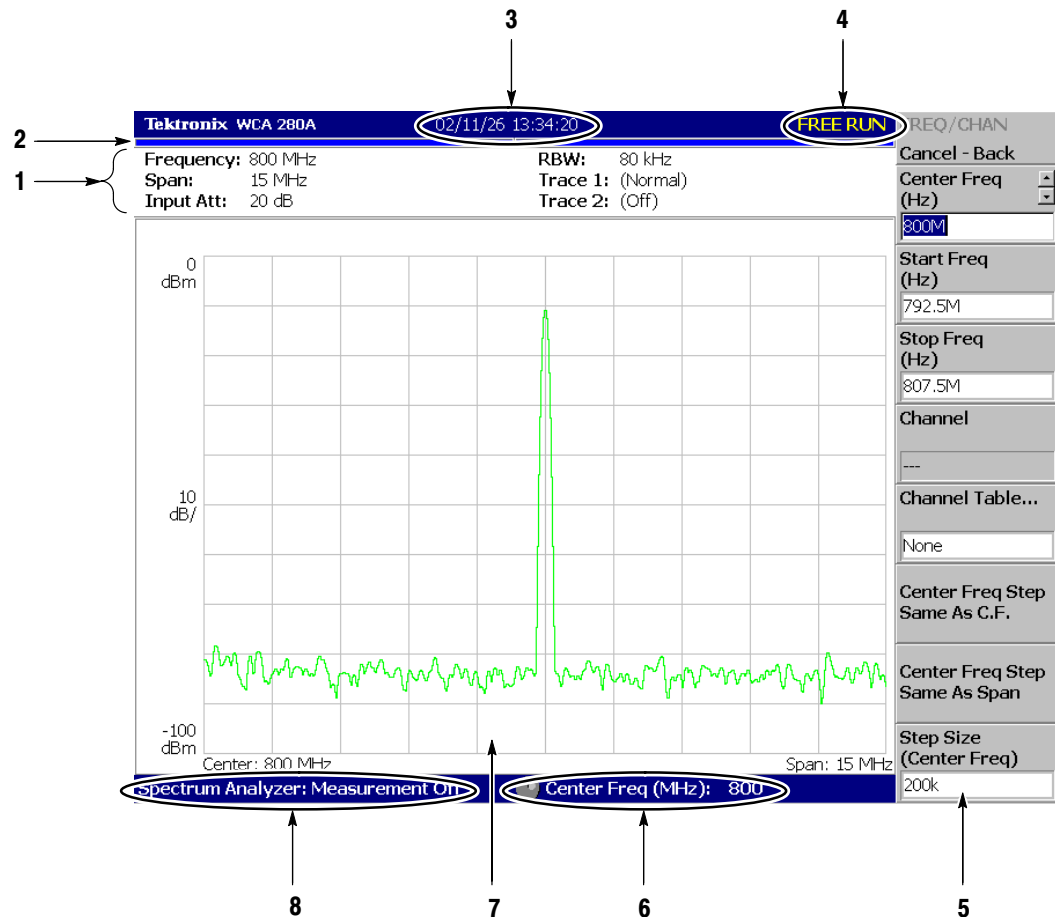

Figure 2–5: Display screen configuration

1. **Setup display area.** Displays the current hardware value. Refer to *Setup Display* on page 2–10.
2. **Progress bar.** Indicates the progress of the acquisition cycle on the left bar and the measurement cycle on the right bar. The progress fills up in blue from left to right.
3. **Date/Time display area.** Shows the current date and time.
4. **Status display area.** Shows the trigger status. Refer to *Status Display* on page 2–8.
5. **Side menu display area.** When you press a menu key on the front panel, the menu associated with that key is displayed. Refer to page 2–17 for details of menu items.

6. **Menu setting display area.** Displays the last setting of the menu item that can be set with the general purpose knob.
7. **View.** The View window displays the waveform or the measurement results. Multiple views can be displayed on one display screen, depending on the measurement mode.

For more information, refer to:

<u>Spectrum analysis (S/A mode)</u>	page 3-1
Modulation analysis (DEMODO mode)	page 3-27
Time analysis (TIME mode)	page 3-53
Scale and format	page 3-63

8. **Measurement function display area.** Displays the measurement function currently in use (the settings of the Mode and Measure menus).

Status Display

The status display area in the upper right side of the screen (see Figure 2–6) shows the instrument status as listed in Table 2–2.

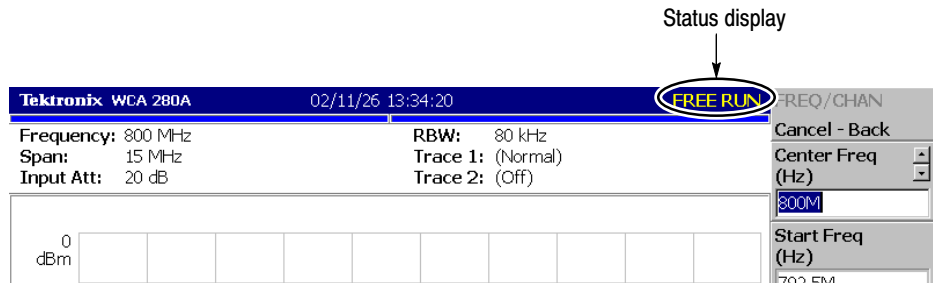

Figure 2–6: Status display

Table 2–2: Status display

Item	Description
ARM	The pre-trigger portion of the acquisition record is filling. A trigger event occurring during this state will not be recognized.
READY	Pre-trigger data has been acquired, and the instrument is waiting for a trigger event.
TRIG'D	Pre-trigger data has been acquired, and a trigger event has been detected. The instrument is now acquiring post-trigger data.
FREE RUN	The instrument acquires and measures without waiting for a trigger event.
PAUSE	The user has temporarily stopped acquisition/measurement cycling.

The acquired data is stored in the data memory from address zero in order of acquisition. When you set a trigger condition, the acquired data is stored in the pre-trigger region until the trigger event occurs. Thereafter, it is stored in the post-trigger region (see Figure 2–7).

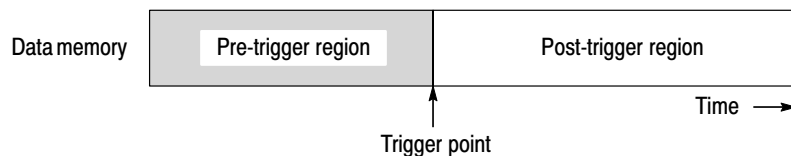

Figure 2–7: Pre- and post-trigger regions

Front Panel Key Lock

When controlling this instrument through GPIB, you can disable all the keys on the front panel except the power switch using the `:SYSTEM:KLOCK` command. At this time, the message “PANEL LOCK” is displayed on the top side key (see Figure 2–8).

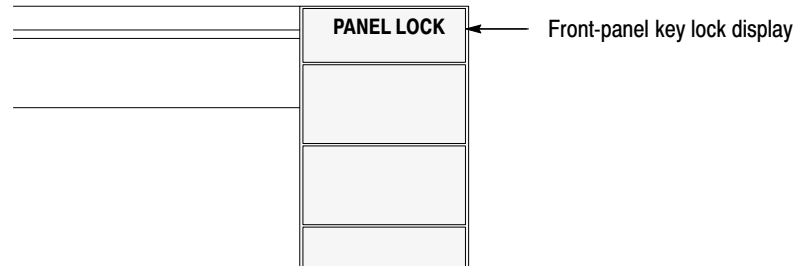

Figure 2–8: Key lock display

To cancel the key lock, the following two methods can be used:

- Use the `:SYSTEM:KLOCK` command to cancel.
- Turn off the power and then on.

Refer to the *WCA230A and WCA280A Programmer Manual* for information about the GPIB commands.

Setup Display The setup display area in the upper part of the screen shows the analyzer hardware settings (see Figure 2–9). The contents differ depending on the measurement mode: spectrum analysis (S/A), modulation analysis (Demod), or time analysis (Time).

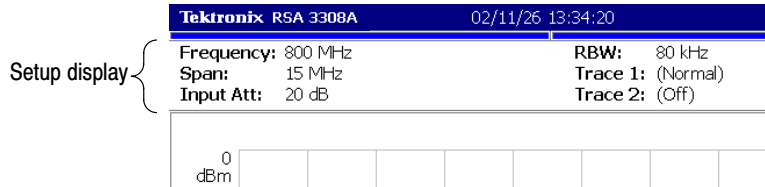

Figure 2-9: Setup display

- **Frequency.** Indicates the center frequency.
- **Span.** Indicates the span.
- **Input Att.** Indicates the attenuation of input signal before it enters the mixer.
- **RBW.** *S/A mode (except real-time mode) only.* Indicates RBW (Resolution Bandwidth). RBW is simulated by the software to maintain compatibility with measurement data of conventional swept spectrum analyzers.
- **Trace 1 and 2.** *S/A mode only.* Indicates the Trace 1 and 2 trace type.
- **Acquisition Length.** *Demod and Time modes only.* Indicates time to acquire each block of data. Acquisition length can be set in the Timing menu.
- **Frame Length.** *Real Time S/A mode only.* Indicates time length of a frame. Refer to Table A–10 in *Appendix A: Specifications* for the frame time.

Menu Operations

This section describes basic operations of the analyzer menus and how to select menu items and input numeric values. Refer to page 2–17 and subsequent pages for details about the menus.

Menu Item Information

Up to nine soft keys can be displayed down the right side of the screen (see Figure 2–10). Cancel - Back is always displayed at the top, and the other eight keys select menu items.

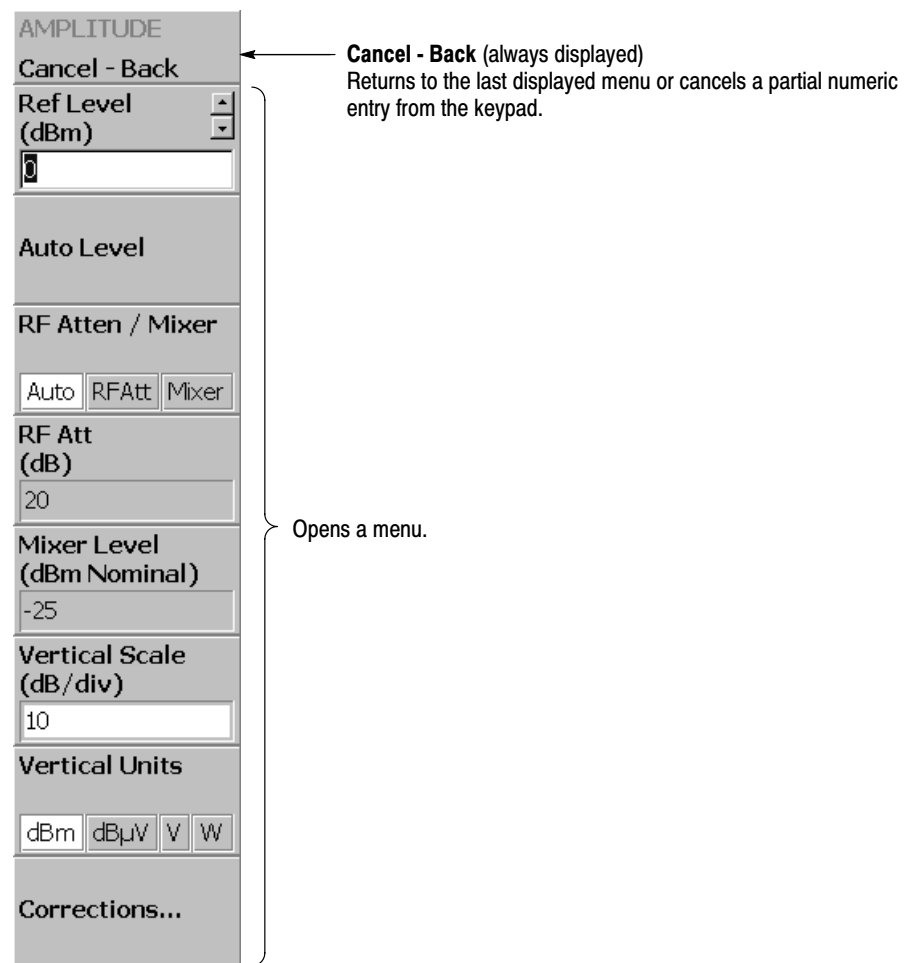

Figure 2–10: Examples of menu item display

NOTE. When the setting is prohibited or is not available, the item is displayed in gray.

Menu Item Types

The different types of menu items are shown in Figure 2–11.



Numeric entry

The current value of parameter is displayed. To change the value, press the associated side key and use the general purpose knob, up/down keys, or the keypad.



Toggle

You can switch selection items by pressing the associated side key.



Function execution

The function indicated on the label is executed by pressing associated side key. In this example, the “Channel Power” measurement is performed.

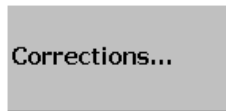

Move to sub-menu

If the label is followed by “...”, you can move to a lower-level menu by pressing the associated side key.

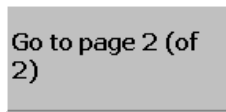

Move between pages

When the number of menu items is greater than seven, this menu appears. To move to the next page, press the associated side key. If you are on the last page, you will return to the first page.



Invalid

Menu items without labels do not cause any action.

Figure 2-11: Menu item types

Numeric Input

An example numeric input field is shown in Figure 2–12. In this type of field, you can change the numeric value by turning the general purpose knob, by pressing the up/down (▲▼) keys, or by entering a value using the keypad.



Figure 2-12: Numeric setting menu

Changing Value Using the General Purpose Knob or the Up and Down keys.

1. Press the side key for setting a numeric value. For example, press **FREQUENCY/CHANNEL** → **Center Freq** to set a center frequency.

The menu item changes to the display as shown in Figure 2–13.

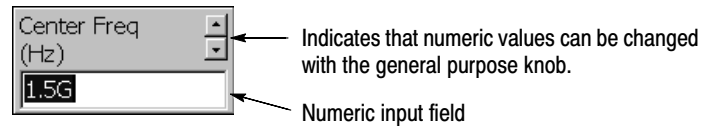
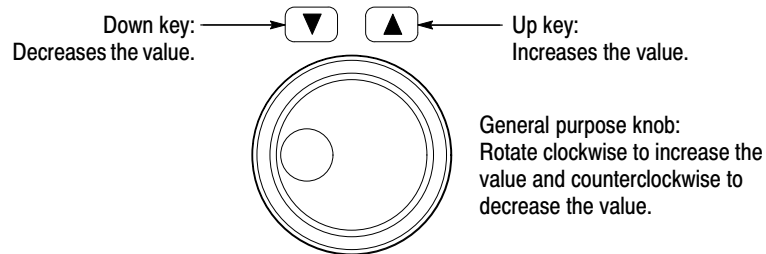

Figure 2–13: Changing value with the knob

2. Turn the general purpose knob to increase or decrease the value.

You can also use the up and down (▲▼) keys to increase or decrease a setting value, respectively.



The up and down keys have the same functions as the general purpose knob except the step size (the amount per click by which the general purpose knob changes a setting value or the amount per press for the up and down keys) as follows:

- For the general purpose knob, the step size is determined internally. You can not change the step size.
- For the up and down keys, the step size is set with the **Step Size** side key. Refer to *Changing the Step Size* on page 2–15 for the detail.

The changed value is immediately reflected on the analyzer settings and displays.

Entering a Value Using the Keypad. You can enter values using the front panel keypad, shown in Figure 2–15.

1. Press the side key for setting a numeric value. For example, press **FREQUENCY/CHANNEL** → **Center Freq** to set a center frequency.

The menu item changes to the display shown in Figure 2–14.

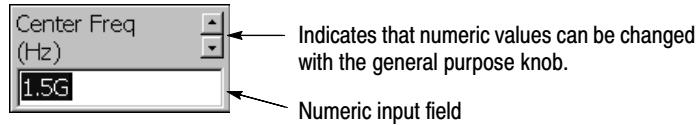

Figure 2-14: Changing value with the keypad

2. Press the keys required to enter the desired numeric value. For example, to enter the frequency 123.45 MHz, press **1 2 3 . 4 5 MHz**.

To delete an entered number, press the **BKSP** (Backspace) key.

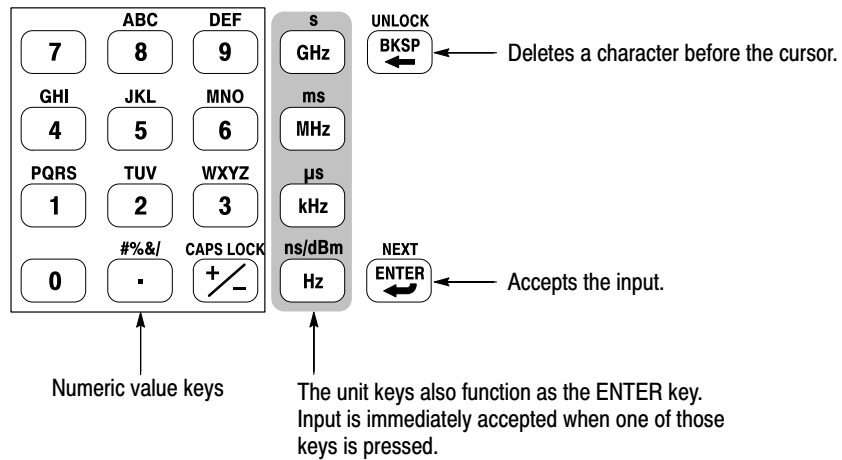

Figure 2-15: Numeric keypad

3. Confirm the input by pressing the unit key or **ENTER** key. The confirmed value is immediately reflected to the analyzer settings and display.

Press the **Cancel - Back** side key to cancel the change.

Changing the Step Size

When using the up and down (▲▼) keys to increase or decrease a setting value, you can change the step size (the amount per press by which the up or down key changes the setting value) with the **Step Size** side key. (The step size cannot be changed for menu items that do not display **Step Size**.)

In the example shown in Figure 2–16, the step size for the start frequency is set to 100 kHz; the displayed frequency set value changes by 100 kHz step for each press of the up or down key.

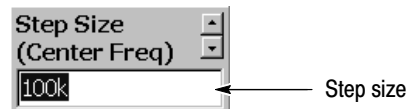

Figure 2–16: Changing the step size for the center frequency

Step Size for Center Frequency. The step size is set with the **Step Size** side key. The center frequency step size can be also set with two side keys in the Frequency/Channel menu (see Figure 2–17 below).

- **Center Freq Step Same As C.F.** Useful for quickly locating harmonics of a signal seen at the center frequency.
- **Center Freq Step Same As Span.** Useful for quickly analyzing a larger frequency area without overlapping span windows.

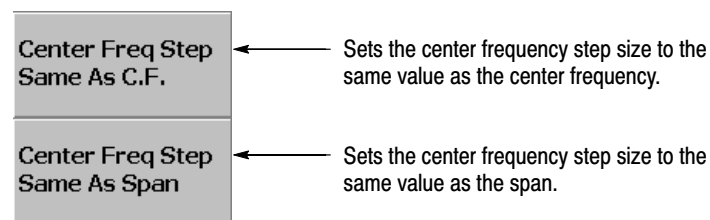

Figure 2–17: Changing the step size for the center frequency

Menu Functions

Menu keys on the front panel (shown in Figure 2–18) are divided into the following three functional groups:

- **MEASUREMENT**
Sets frequency, amplitude, and time parameters for specified measurement and controls data acquisition.
- **DISPLAY**
Selects measurement mode, sets view display, and controls markers.
- **UTILITY**
Provides system initialization, waveform storage facilities, instrument calibration, screen hard copy, and miscellaneous other functions.

This section describes the individual menu functions in detail.

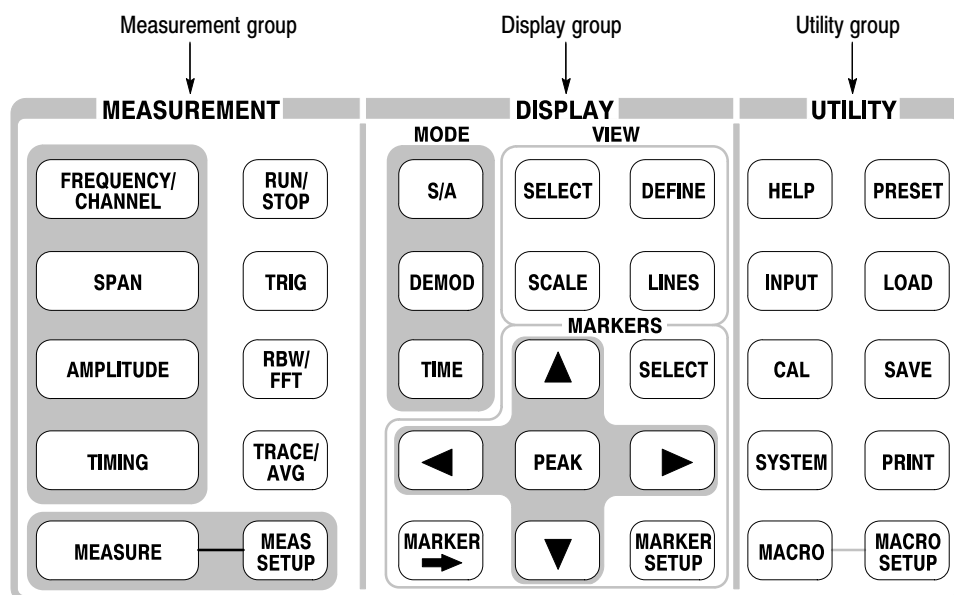

Figure 2–18: Menu keys

Measurement Menu

The Measurement menu, shown in Figure 2–19, sets the frequency, amplitude, and time parameters for the specified measurement, and controls data acquisition.

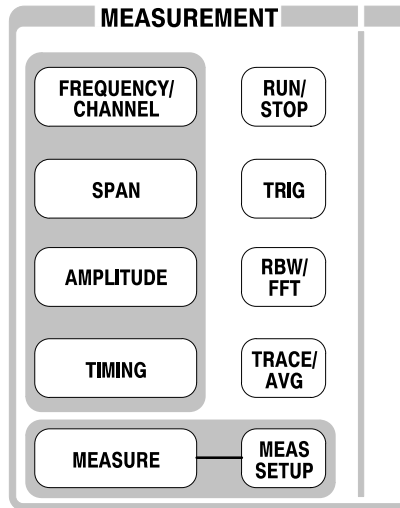

Figure 2–19: Measurement menu keys

FREQUENCY/CHANNEL

Sets frequency or channel.

Center Freq. Sets the center frequency. Numeric entry field.

Range: 0 Hz to 3 GHz (WCA230A), 0 Hz to 8 GHz (WCA280A)

Start Freq. Sets the value of the origin of the horizontal axis (frequency).
Numeric entry field.

Range: 0 Hz to 3 GHz (WCA230A), 0 Hz to 8 GHz (WCA280A)

Stop Freq. Sets the value of the end point of the horizontal axis (Frequency).
Numeric entry field.

Range: 0 Hz to 3 GHz (WCA230A), 0 Hz to 8 GHz (WCA280A)

NOTE. *Start Freq and Stop Freq are available when the measurement mode (Mode) is set to spectrum analysis (S/A except real-time).*

The values of Center Freq, Start Freq, Stop Freq, and Span are set in conjunction with each other. The relationship is described as $(\text{Stop Freq}) - (\text{Start Freq}) = (\text{Span})$. When one value is set, the other values are automatically changed accordingly.

Channel. Selects a channel number to set the center frequency from a channel table specified with the **Channel Table...** menu item below.

Channel Table... Selects a communication standard to load the channel table. Select a channel number with the **Channel** menu item above.

For using the channel tables, refer to page 3–81.

Center Freq Step Same As C.F. Sets the center frequency step size equal to the center frequency.

Center Freq Step Same As Span. Sets the center frequency step size equal to the span.

Step Size. Sets the step size (amount per press by which the up or down key (\blacktriangle / \blacktriangledown) changes the setting value) for setting frequency.

SPAN Controls span. Span and frequency settings are shown in Figure 2–20.

NOTE. *For details about setting frequency and span, refer to Setting Frequency and Span on page 3–79.*

Span. Sets span. The available range depends on the measurement frequency band and mode as shown in Table 2–3.

Turn the general purpose knob to set span in the specified sequence. In the S/A mode (except real-time), you can set an arbitrary span within the limit using the numeric keypad.

Table 2-3: Span setting range

Measurement mode	Band ¹	Setting range
S/A (except real-time)	RF	50 Hz to 3 GHz (1-1.2-1.5-2-2.5-3-4-5-6-8 sequence)
	Baseband	50 Hz to 20 MHz (1-1.2-1.5-2-2.5-3-4-5-6-8 sequence)
S/A (real-time) Demod, Time	RF	100 Hz to 10 MHz (1-2-5 sequence) and 15 MHz
	Baseband	100 Hz to 20 MHz (1-2-5 sequence)

¹ Baseband: DC to 20 MHz; RF: 15 MHz to 3 GHz (WCA230A) / 8GHz (WCA280A)

Start Freq. Sets the value of the origin of the horizontal axis. This is the same as *Start Freq* on page 2-18.

Stop Freq. Sets the value of the end point of the horizontal axis. This is the same as *Stop Freq* on page 2-18.

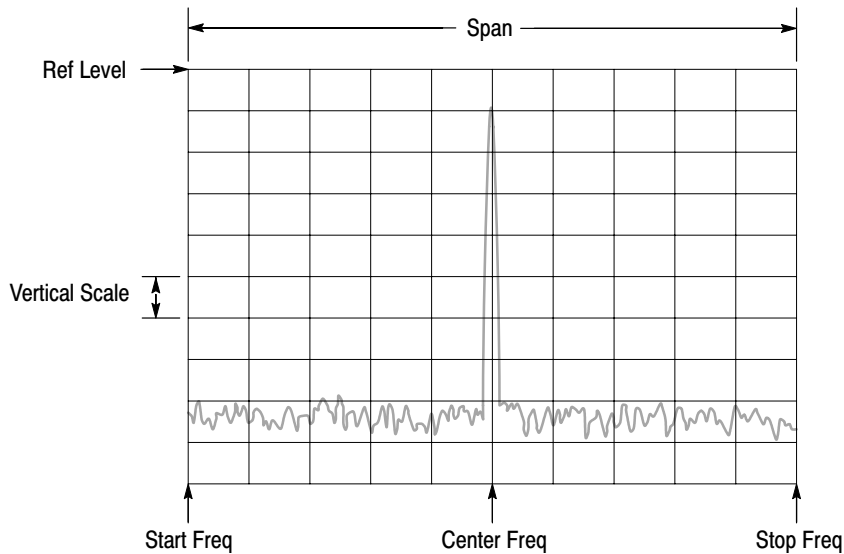

Figure 2-20: Setting frequency, span, and amplitude

AMPLITUDE Sets the scale of the amplitude of the displayed waveform.

NOTE. For details about setting amplitude, refer to Setting Amplitude on page 3–87.

Ref Level. Sets the maximum (top) edge of the vertical axis. The available range depends on the measurement frequency band as shown in Table 2–4.

Table 2–4: Reference level setting range

Frequency band	Setting range
Baseband (DC to 20 MHz)	–30 to +20 dBm (2 dB step)
RF (15 MHz to 3 GHz, WCA230A) RF1 (15 MHz to 3.5 GHz, WCA280A)	–51 to +30 dBm (1 dB step)
RF2, 3 (3.5 GHz to 8 GHz, WCA280A)	–50 to +30 dBm (1 dB step)

Auto Level. Automatically adjusts reference level for the best system performance based on power measurement within the set span.

NOTE. An input signal within 10 MHz of the center frequency may cause Auto Level to choose the wrong reference level.

Auto Level will force the analyzer to acquire new data, which will overwrite the existing data.

RF Atten/Mixer. Input signals are attenuated through the attenuator and converted to IF signals through the mixer in the down-converter. Normally, the mixer level and the RF attenuation level are automatically set. Select **RF Att** or **Mixer** to manually set either parameter.

- **Auto.** Sets the mixer level and the RF attenuation level automatically.
- **RF Att.** Sets the RF attenuation level with **RF Att** described below.
- **Mixer.** Sets the mixer level using the **Mixer Level** setting.

RF Att. Changes the RF attenuation level when **RF Att** is selected in **RF Atten/Mixer** above. The available range depends on the measurement frequency band as shown in Table 2–5.

Table 2-5: RF attenuation level setting

Frequency band	RF attenuation level (dB)
RF (15 MHz to 3 GHz, WCA230A) RF1 (15 MHz to 3.5 GHz, WCA280A)	0 to 50 (2 dB step)
RF2, 3 (3.5 GHz to 8 GHz, WCA280A)	0, 10, 20, 30, 40, 50

Mixer Level. Selects the input level of the primary mixer when **Mixer** is selected in **RF Atten/Mixer**. The setting range depends on the measurement frequency band as shown in Table 2-6.

Table 2-6: Mixer level setting

Frequency band	Mixer level (dBm)
RF (15 MHz to 3 GHz, WCA230A) RF1 (15 MHz to 3.5 GHz, WCA280A)	-5, -10, -15, -20, -25
RF2, 3 (3.5 GHz to 8 GHz, WCA280A)	-5, -15, -25

Select the level according to measurement type. The default value is -25 dBm. Use the default value in most cases. This level can be increased up to -5 dBm when a high dynamic range is required for measurements such as ACPR (Adjacent Channel Leakage Power Ratio) measurement.

NOTE. *As the mixer level increases, the distortion also increases.*

Vertical Scale. *S/A mode (except Real Time) only.* Sets the vertical scale (per division). The setting range depends on Vertical Units described below, as shown in Table 2-7.

Table 2-7: Vertical scale setting range

Vertical units	Scale setting
dBm, dB μ V	1, 2, 5, 10
V	200n to 20m in a 1-2-5 sequence
W	100p to 100 μ in a 1-2-5 sequence

Vertical Units. Selects the unit of amplitude scale: dBm, dB μ V, V, or W.

Corrections... Sets amplitude correction. Refer to page 3–91 for details of amplitude correction. The following items can be set:

- **Amplitude Offset.** Sets the amplitude offset. The amplitude of an entire waveform decreases by the offset value.

NOTE. *The following Corrections menu items are available in the S/A (spectrum analysis) mode except Real Time S/A.*

- **Frequency Offset.** Sets the frequency offset. The effective correction range of the amplitude correction table shifts by the offset value.
- **Amplitude Table.** Enables or disables amplitude correction. Select On to enable the correction.
- **Edit Table...** Creates a correction table. Input pairs of frequency and amplitude correction value.
 - **Select Point To Edit.** Selects a row to be edited.
 - **Frequency.** Enters the frequency of a correction point.
 - **Amplitude.** Enters an amplitude correction value for the specified frequency.
 - **Delete Point.** Deletes the selected row.
 - **Add New Point.** Adds a row with the values in the previous row copied as initial values.
 - **Done Editing Table.** Confirms the input and adds a new row.
 - **Clear Table.** Deletes the correction data from the memory.
- **Interpolation...** Selects the horizontal and the vertical scale for interpolating correction data.
 - **Freq Interpolation.** Selects the horizontal scale for interpolating correction data: Linear or Logarithmic.
 - **Ampl Interpolation.** Selects the vertical scale for interpolating correction data: Linear or dB.
- **Load Table.** Reads an amplitude correction table from a file.
- **Save Table.** Writes a created correction table to a file.

Refer to page 3–153 for details on file operations.

TIMING Adjusts the length of various time parameters and the relationship between them. For the details, refer to *Acquiring Data* on page 3–109.

NOTE. *The Timing menu is available when the measurement mode (Mode) is real-time spectrum analysis (Real Time S/A), modulation analysis (Demod), or Time analysis (Time).*

Real Time S/A Mode

Acquisition Length. Sets the time length to acquire one block (= M frames). The acquisition length is calculated with this equation:

$$\text{(One block acquisition length)} = M \times \text{(One frame acquisition length)}$$

where M is the number of frames a block.

One frame acquisition length is determined by span internally. For details, refer to Table A–10 on page A–8 in *Appendix A: Specifications*.

Spectrum Offset. Specifies the number of the frame in the spectrogram to display the spectrum. The latest frame is number zero. Older frames have larger negative numbers.

Demod and Time Modes

Acquisition Length. Same as Acquisition Length in the Real Time S/A mode.

Acquisition History. Specifies the number of the block to display and analyze. The latest block is number zero. Older blocks have larger negative numbers.

Spectrum Length. Displays a time length of FFT processing for the spectrum displayed in the subview.

Spectrum Offset. Sets the beginning of Spectrum Length with respect to the trigger output point.

Analysis Length. Sets a time length of analysis range on acquired data.

Analysis Offset. Sets the beginning of Analysis Length with respect to the trigger output point.

RUN/STOP Starts or stops data acquisition.

If acquisition and measurements are waiting for a trigger, or are paused/stopped, pressing this key will start the acquisition. If acquisition and measurements are running, pressing this key will stop acquisition and measurements, aborting the current acquisition.

TRIG Sets trigger conditions. Refer to *Trigger* on page 3–115 for details.

NOTE. *Except for the Repeat menu item, the Trigger menu is available when the measurement mode is set to Real Time S/A, Demod, or Time.*

Mode... Selects the trigger mode.

- **Free Run.** Acquires and displays the waveform without triggering. Press the **RUN/STOP** key to start data acquisition. To stop the acquisition, press the **RUN/STOP** key again.
- **Triggered.** Set the trigger conditions (level, slope, and position) before starting data acquisition by pressing the **RUN/STOP** key. When the trigger occurs, data is acquired and displayed. To stop data acquisition when the trigger does not occur, press the **RUN/STOP** key again.

Repeat... Selects whether to acquire data continuously or singly.

- **Continuous.** Repeatedly acquires and displays the waveform. Acquisition data will be overwritten while waiting for a new trigger event. Use the Single setting if you will need to examine or reanalyze the measurement results.
- **Single.** Acquires and displays one waveform. After the first waveform display, you must press RUN/STOP to acquire and display each waveform.

Stop and Show Results. Stops data acquisition and shows measurement results.

When you press the RUN/STOP key to stop data acquisition, the block data acquired at that moment is discarded and the measurement results are shown for the previous block of data. The Stop and Show Results side key, however, shows measurement results even for the block of data acquired at the moment of pressing the side key, which might not fill a whole block.

Source. Selects a trigger source when the trigger mode is Triggered.

- **Level (Full BW).** *Default.* Uses the internal IF (intermediate frequency) signal of the analyzer as the trigger source. The trigger level and position can be set.
- **Power (Span BW).** *Option 02 only.* Uses the input signal as the trigger source in the time domain.
- **Freq Mask.** *Option 02 only.* Uses a trigger mask as the trigger source. Refer to page 3–123 for information about creating the trigger mask.
- **External.** Uses the external signal input from the TRIG IN connector on the rear panel as the trigger source. The trigger slope and position can be set. For the specification of the external trigger, refer to page A–12.

Define Mask... *Option 02 only.* Creates a trigger mask when the trigger mode is set to Triggered and the source is set to Freq Mask.

The trigger mask is created in the spectrum view using the marker and the reference cursor. Refer to page 3–123 for details on creating a trigger mask.

- **Select Marker.** Select Marker 1 or 2 to operate.
- **Marker X Horizontal.** Sets the horizontal position of the active marker.
- **Marker X Vertical.** Sets the vertical position of the active marker.
- **Markers.** Selects the marker mode:
 - **Off.** Displays no marker.
 - **Single.** Displays one marker (Marker 1).
 - **Delta.** Displays two markers (Marker 1 and 2).
- **Reference Cursor to Marker X.** Enables the Reference Cursor, at the same position as the selected marker. Only available when the selected view can contain a reference cursor.
- **Reference Cursor Off.** Turns off the Reference Cursor. Only available when the selected view can contain a reference marker.
- **Selected Marker Off.** Turns off the selected marker.
- **All Markers Off.** Turns off both markers, the reference cursor, and all their readouts.
- **Draw Max.** Fills the area below the maximum line (= reference level).
- **Draw Line.** Fills the area below the line connecting the draw line under setting and the two markers.

- **Draw Min.** Fills the area below the minimum line (the level lower than the reference level by 60 dB for 15 MHz span, and by 70 dB for all other spans).
- **Draw Horizontal.** Fills the area below the horizontal line including the active marker location.

Slope. Selects the trigger slope when the trigger mode is Triggered and the trigger source is External.

- **Rise.** Trigger occurs on the rising part of the input signal.
- **Fall.** Trigger occurs on the falling part of the input signal.
- **Rise and Fall.** Trigger occurs on the rising part of the trigger signal for the first block to acquire data, and on the falling part of the trigger signal for the next block to acquire data. The rising and falling parts alternate for each block of data acquisition.
- **Fall and Rise.** Trigger occurs on the falling part of the trigger signal for the first block to acquire data, and on the falling part of the trigger signal for the next block to acquire data. The rising and falling parts alternate for each block of data acquisition.

When using a trigger mask (Option 02 only). When the trigger source is set to Freq Mask for using a trigger mask, the following selection items are available:

- **In.** The trigger occurs when a measurement signal exits the blue area of a trigger mask and enters the black area.
- **Out.** The trigger occurs when a measurement signal exits the black area and enters the blue area of a trigger mask.
- **In and Out.** The analyzer triggers with In to acquire the first block, and Out to acquire the second. In and Out alternate at each block acquisition.
- **Out and In.** The analyzer triggers with Out to acquire the first block, and In to acquire the second. In and Out alternate at each block acquisition.

Level. Available when the trigger mode is set to Triggered and the trigger source is set to Level or Power. Sets the trigger level.

Range: 1 to 100% in 1% step (Level); -40 to 0 dBfs in 1 dBfs step (Power).

When the trigger source is set to External, the trigger level is fixed internally. Refer to page A-12 for the specification of external trigger.

Position. Available when the trigger mode is set to Triggered. Specifies the position of the trigger in a block as a percentage of all the frames in the block. For example, when trigger position is set at 50%, the center frame of the block will generate triggers. Range: 0 to 100% in 1% step.

RBW/FFT The input signal is applied RBW (Resolution Bandwidth) processing after FFT processing. RBW is simulated by calculation to maintain compatibility with measurement data from conventional swept spectrum analyzer.

Refer to *FFT and RBW* on page 3–101 for the detail.

NOTE. *The RBW/FFT menu is available when measurement mode (Mode) is S/A (except Real Time). In Real Time S/A, DEMOD, and TIME modes, the FFT size is fixed to 1024 points, the window is fixed to Blackman-Harris 4B, and no RBW processing is available.*

RBW/FFT. Selects whether to set RBW and FFT parameters automatically or manually.

- **Auto.** Sets RBW automatically with the span setting. The filter shape is set to Gaussian.
- **Man.** Sets RBW and selects the filter manually with the **RBW** and **RBW Filter Shape...** side keys.
- **FFT.** Sets the FFT points and window manually with the **FFT Points** and **FFT Window...** side keys. The result of FFT processing is displayed as is, without RBW processing.

RBW. Sets RBW when Man is selected in RBW/FFT.
Range: 2 kHz to 2 MHz (default: 80 kHz)

RBW Filter Shape... Selects a filter from the following four types when Man is selected in RBW/FFT: Rect (Rectangular), Gaussian, Nyquist, and Root Nyquist

Rolloff Ratio. Enters roll-off ratio when RBW Filter Shape is set to Nyquist or Root Nyquist. Range: 0.0001 to 1 (default: 0.5).

Extended Res. The FFT point number is normally limited internally. You can eliminate the limit with the On setting. Refer to *Limit on the FFT Points* on page 3–103 for the detail.

NOTE. *It is recommended to keep Extended Res. Off as its default condition.*

FFT Points. Selects FFT sample point numbers per frame when RBW/FFT is set to FFT. Range: 64 to 65536 at 2ⁿ step. Higher numbers provide higher resolution, and lower numbers provide faster measurements.

FFT Window... Selects the FFT window (window function) when RBW/FFT is set to FFT. Default: Blackman-Harris 4B.

TRACE/AVG

Controls the trace display and averaging. The menu items vary according to the measurement mode: S/A, Demod, or Time.

S/A Mode

NOTE. *The Trace/Avg menu is not available in the Real Time S/A mode.*

You can display two traces of different types concurrently on screen. Trace 1 is displayed in yellow and Trace 2 in green. For details on trace control, refer to *Trace Comparison Display and Average Function* on page 3–131.

Select Trace. Selects the trace to control: trace 1 or 2.

Trace 1/2. Control the selected trace.

- **On.** Turn on the selected trace.
- **Freeze.** Freezes display of the selected trace.
- **Off.** Turn off the selected trace.

Trace 1/2 Type... Selects the type of processing for the selected trace.

- **Normal.** Displays normal waveform without averaging.
- **Average.** Averages the selected trace.
- **Max Hold.** Holds the maximum value at each data point on the waveform.
- **Min Hold.** Holds the minimum value at each data point on the waveform.

Number Of Averages. Specifies how many traces are accumulated to create the averaged value. Setting range: 1 to 100000 (default: 20).

Averaging can be controlled in two ways:

- If the trigger mode is Free Run in continuous acquisition, traces average until the number of traces exceeds Number of Averages is reached, at which time the oldest traces in the accumulator exponentially decay.
- If the trigger mode is Triggered or the acquisition mode is Single, the number of averages accumulates up to Number of Averages, then the acquisition stops until the next trigger event occurs.

Reset Average. Resets average, max hold, or min hold, restarting trace accumulation.

Display Detection... The bin data is thinned out in the display because the number of pixels in the horizontal direction of the screen is generally smaller than the number of bins in the FFT. Display Detection selects the method to be used for decimating traces to fit the available space. It is related only to the thinning of displayed data.

- **Max-Min.** Draws a line connecting the maximum and the minimum values of data corresponding to each pixel.
- **Max.** Displays the maximum value of data corresponding to each pixel.
- **Min.** Displays the minimum value of data corresponding to each pixel.

The analyzer performs RMS detection using the linear A/D converter regardless of the Display Detection setting.

Refer to page 3–138 for details on compression of waveform display data.

Load Trace. Loads trace data from a file.

Save Trace. Saves trace data to a file.

Refer to *File Operations* on page 3–153 for details on saving/loading data to/from a file.

Demod and Time Modes

Average. Determines whether to perform averaging.

- **On.** Turn averaging on.
- **Off.** Turn averaging off.

NOTE. For Demod and Time modes, data is always acquired without averaging.

Average Count. Specifies the number of measurements to combine.
Setting range: 1 to 10000 (default: 20).

Average Term Control. Specifies the action when more than Average Count measurement results are generated.

- **Expo.** Continues the average with an exponential weighting applied to old values.
- **Repeat.** Clears average data and counter, and restarts the average process.

MEASURE Selects a measurement item. Measurement items vary depending on the Mode setting (refer to page 2–32).

MEAS SETUP Sets parameters for the measurement item selected in MEASURE.

For details about MEASURE and MEAS SETUP, refer to:
Spectrum analysis (S/A mode) page 3–1
 Modulation analysis (Demod mode) page 3–27
 Time analysis (Time mode) page 3–53

For details on the following optional software, refer to each user manual:
Option 22: W-CDMA downlink analysis software
 Option 23: W-CDMA uplink analysis software
 Option 24: GSM/EDGE analysis software
 Option 25: cdma2000 analysis software
 Option 26: 1xEV-DO analysis software

Display Menu

The Display menu is shown in Figure 2–21. This menu is divided into three blocks:

- **MODE:** Selects the measurement mode.
- **VIEW:** Sets the scale and format of views and controls the display line.
- **MARKERS:** Controls the markers and peak search.

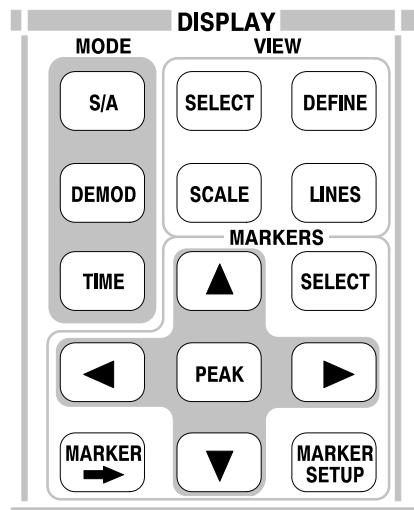

Figure 2-21: Display menu keys

Mode Menu Selects the measurement mode.

S/A Performs a general spectrum analysis.
Refer to *Spectrum Analysis* on page 3–1 for details.

DEMOD Performs digital or analog modulation analysis.
Refer to *Modulation Analysis* on page 3–27 for details.

TIME Performs time characteristic analysis.
Refer to *Time Analysis* on page 3–53 for details.

- View Menu** Sets scale and format of views and controls the display line. Refer to *Scale and Format of View* on page 3–63 for details.
- SELECT** Selects the next view from all views in the selected measurement configuration.
- SCALE** Scales the selected view (refer to page 3–63).
- DEFINE** Defines the selected view (refer to page 3–63).
- LINES** Controls the display line (see Figure 2–22). Refer to *Display Line* on page 3–149 for the details.

NOTE. The Lines menu is available in the S/A (spectrum analysis) mode except Real Time S/A.

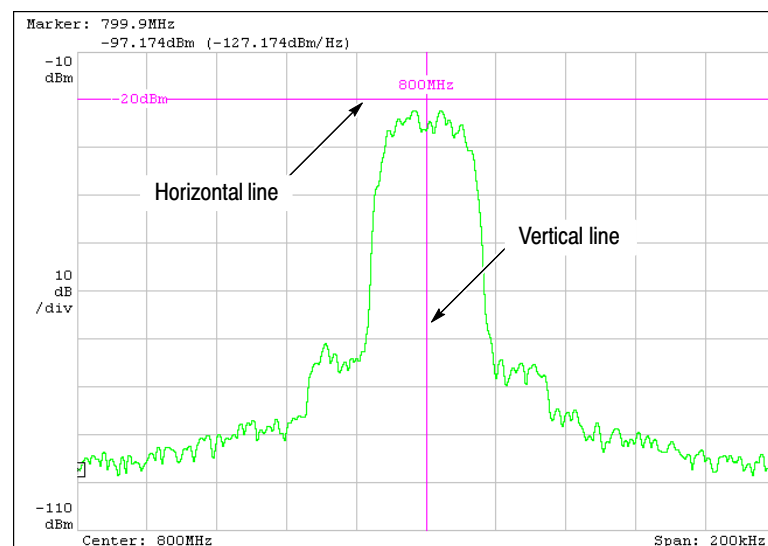

Figure 2–22: Display line

Show Line. Selects the display line to be controlled: Horizontal or Vertical.

Number Of Line. Selects how many horizontal lines are displayed on the graph: None, 1 or 2.

Line 1. Sets the position of the first line.

Line 2. Sets the position of the second line.

Delta. Sets the difference between the first and second lines:
 (Value of Line 2) – (Value of Line 1)

Markers Menu

Operates markers, shown in Figure 2–23. The markers are also used for peak search. Refer to *Marker Operation and Peak Search* on page 3–141 for details.

SELECT

Selects which marker is being controlled in the delta marker mode. If markers are disabled, pressing this key enables Marker 1.

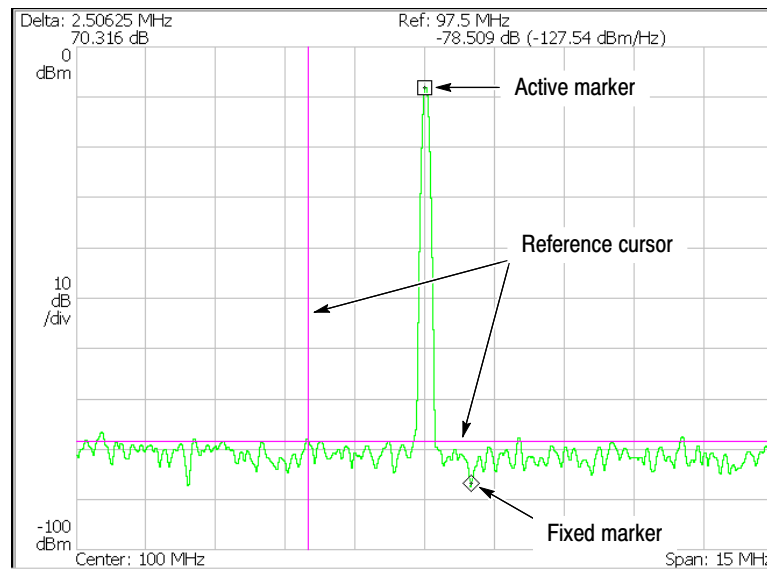

Figure 2–23: Marker display

MARKER SETUP

Set up the behavior of the markers.

Select Marker. Selects which marker is being controlled in the delta marker mode. Same as MARKERS: **SELECT**.

Marker X Position. Sets the horizontal position of the selected marker.

Markers. Selects the marker mode:

- **Off.** Displays no marker.
- **Single.** Displays one marker (Marker 1).
- **Delta.** Displays two markers (Marker 1 and 2).

Reference Cursor to Marker X. Enables the Reference Cursor, at the same position as the selected marker. Only available when the selected view can contain a reference cursor.

Reference Cursor Off. Turns off the Reference Cursor. Only available when the selected view can contain a reference marker.

Selected Marker Off. Turns off the selected marker.

All Markers Off. Turns off both markers, the reference cursor, and all their readouts.

Assign Marker X to Trace. When two traces are being displayed, moves the selected marker to another trace with the same horizontal position. Available only if two traces are being displayed.

Peak Search Freq. Threshold. *S/A mode only.* Sets the minimum frequency jump that should be made when selecting the next signal to the left/right/up/down.

Peak Search Hor. Threshold. *Demod and Time modes only.* Selects the minimum horizontal jump that should be made when selecting the next signal to the left/right/up/down.

Marker X Vertical. *Spectrogram view in the Real Time S/A mode only.*

Specifies the number of the frame in the spectrogram to display the spectrum. The latest frame is number zero. Older frames have larger negative numbers. Same as Spectrum Offset in the Timing menu.

Reference Cursor to Trigger. *Demod and Time modes only.* Enables the Reference Cursor at the same position as the trigger occurrence in the overview. The marker readout at the upper left of the screen is relative to the Reference Cursor.

Reference Cursor to Trigger Output. *Demod and Time modes only.* Enables the Reference Cursor at the same position as the trigger output in the overview. The marker readout at the upper left of the screen is relative to the Reference Cursor.

MARKER ➡ Sets instrument parameters based on the marker position(s).

Center Freq = Marker Freq. Changes the center frequency to match the current marker position.

Analysis Time = Marker Time. *Demod and Time modes only.* Sets the origin of an analysis range with the marker in the overview. For the detail, refer to *Setting Analysis Range for the Main View* on page 3–29.

PEAK Positions the marker to the highest peak signal.

Marker Left (◀) Moves the marker lower in frequency to the next signal.

Marker Right (▶) Moves the marker higher in frequency to the next signal.

Marker Up (▲) Moves the marker higher in amplitude to the next signal.

Marker Down (▼) Moves the marker lower in amplitude to the next signal.

The definition of “next” can be set in the MARKER SETUP menu, using Peak Search Freq. Threshold and Peak Search Ampl. Threshold.

Utility Menu

The Utility menu provides system initialization, waveform storage facilities, instrument calibration, screen hard copy, and miscellaneous other functions. The Utility menu keys are shown in Figure 2–24.

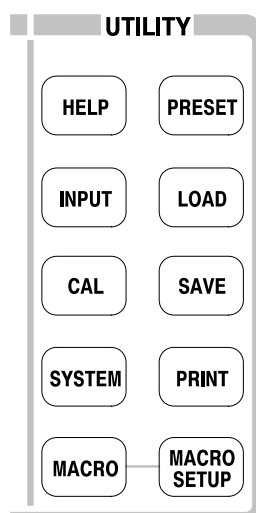

Figure 2–24: Utility menu keys

HELP Shows online help. Refer to *Using the Online Help* on page 3–185 for details.

View Front Panel Button Help. Displays descriptions of the front panel key that you have selected.

View Online User Manual. Displays the online user manual.

View Online Programmer Manual. Displays the online programmer manual.

INPUT Selects which input to use.

Signal Input Port... Selects which input is used for signal connection.

- **RF.** Uses the signal from the INPUT connector on the front panel.
- **IQ.** *Option 03 only.* Uses the signal from the I INPUT and Q INPUT connectors on the rear panel.
- **Cal.** Uses the internal calibration signal (50 MHz, -10 dBm). The signal is connected internally.

Reference Source. Selects the source for reference frequency.

- **Int.** Uses the internal clock (10 MHz simulated sine wave).
- **Ext.** Uses the 10 MHz sine wave of -10 to +6 dBm from the REF IN connector on the rear panel when you want to synchronize the analyzer with other instrument(s).

The reference clock is available from the REF OUT connector on the rear panel.

CAL Calibrates the analyzer.

Calibrate All. Performs all possible calibration operations.

Calibrate Gain. Calibrates the internal gain steps.
Refer to page 1-21 for the RF gain calibration.

Calibrate Center Offset. This calibration cancels a center offset.
Refer to page 1-23 for center offset calibration.

Calibrate DC Offset. This calibration cancels DC offset in baseband.
Refer to page 1-24 for DC offset calibration.

Auto Calibration. Determines whether to perform the RF gain calibration automatically.

Service... This menu item is only to be used by qualified personnel for repair and calibration. Refer to the *WCA230A and WCA280A Service Manual* for details.

SYSTEM Selects system-wide parameters.

Display Brightness. Adjusts the brightness of display. Setting range: 0 to 100.

Reset All to Factory Defaults. Sets all parameters for all measurements and modes to default values.

Remote Setup... Sets GPIB parameters. Refer to the Programmer Manual for details.

Versions and Installed Options. Displays the current versions of all standard and optional software, and any third party software licenses. Refer to page 3–189 for information about displaying versions and installed options.

PRESET Returns the instrument settings to the factory defaults for the current measurement mode: Spectrum Analyzer, S/A with Spectrogram, Real Time S/A, Analog Demod, Digital Demod (Option 21 only), Transient, or CCDF. Refer to *Appendix B* for the factory defaults.

LOAD Loads waveform data or instrument settings from a file. Refer to page 3–153 for information about handling files.

Load State. Loads the instrument settings.

Load Data. *Real Time S/A, Demod, and Time modes only.* Loads waveform data (IQ data in the time domain).

NOTE. *The menu items below (Load Trace 1, Load Trace 2, and Correction) are available in the S/A mode except real-time.*

Load Trace 1. Loads data for Trace 1 of a graph.

Load Trace 2. Loads data for Trace 2 of a graph.

Load Correction. Loads a correction table of Frequency/Amplitude pairs used for adjusting amplitude values.

SAVE Saves waveform data or instrument settings to a file.
Refer to page 3–153 for information about handling files.

Save State. Saves the instrument settings.

Save Data. *Real Time S/A only.* Saves waveform (IQ data in the time domain).

Save Data... *Demod and Time modes only.* Saves waveform data (IQ data in the time domain) specified with the following submenu:

- **All Blocks.** Saves all the blocks.
- **Current Block.** Saves the block currently displayed.
- **Current Area.** Saves the data displayed in the main view.

NOTE. *The menu items below (Save Trace 1, Save Trace 2, and Correction) are available in the S/A (spectrum analysis) mode except Real Time S/A.*

Save Trace 1. Saves data for Trace 1 of a graph.

Save Trace 2. Saves data for Trace 2 of a graph.

Save Correction. Saves a correction table of Frequency/Amplitude pairs used for adjusting amplitude values.

PRINT Prints the screen image. Refer to page 3–181 for details of screen hard copy.

Print now. Starts printing a copy of the analyzer screen on the specified printer.

Save screen to file.... Invokes the save menu to save the bitmap file.
Refer to page 3–153 for handling files.

Background color. Selects the background color for printing.

- **Black.** Prints the screen background in black.
- **White.** Reverses the screen background to white.

Printer... Specifies the printer.

MACRO Displays a menu listing all currently defined macros.

NOTE. *For installing user-specific macros, contact your local Tektronix distributor or sales office.*

MACRO SETUP Displays a menu to configure macros that have been installed in the instrument.

Tutorial

This section describes how to perform basic procedures; it contains practical examples of applying power, displaying the results of measurements, and shutting off the analyzer. This section uses default settings in most examples.

- Preparations: Connecting devices and applying the power
- Displaying spectrum
- Using markers and peak search
- Using averaging and comparison displays
- Displaying spectrogram
- Spectrum analysis
- Modulation analysis
- Shutting off the power

You must complete the installation procedures (starting on page 1–9) before performing any of the following steps.

Preparations

This tutorial uses a digitally-modulated signal. The following equipment is used as a signal source.

- Digitally-modulated signal generator (recommended: Anritsu MG3671A)
- One 50 Ω coaxial cable

Connecting the Signal Generator

1. Connect the output of the signal generator to the RF INPUT connector on the analyzer front panel using a coaxial cable (see Figure 2–25).

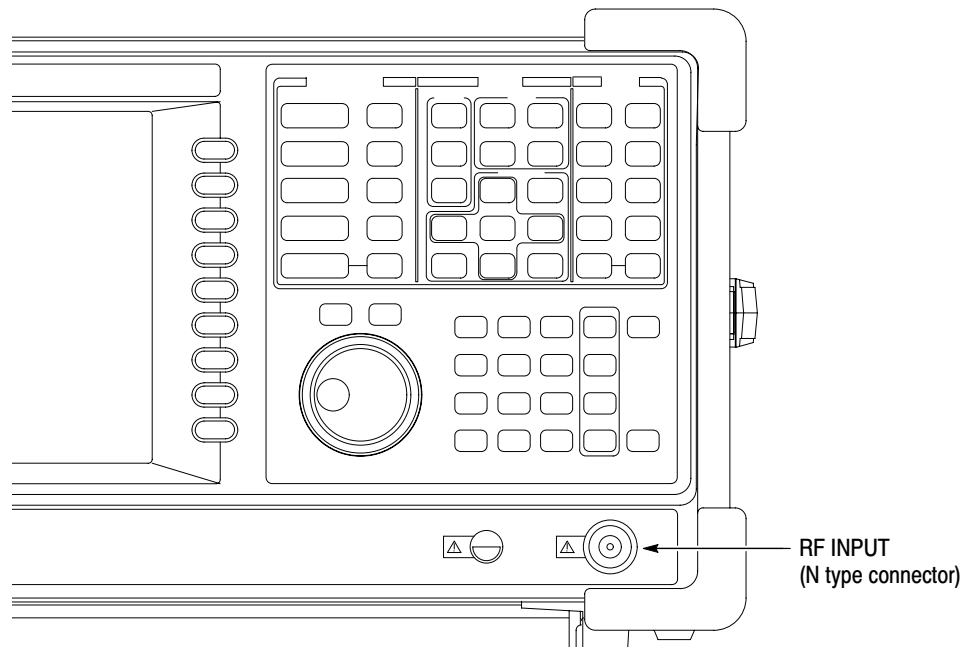

Figure 2–25: Cable connection

2. Set the signal generator as follows:

Modulation system	PDC
Modulation data	Pseudo-random pattern
Center frequency	800 MHz
Output level	–10 dBm

Applying the Power

1. Apply power to the signal generator.
2. Turn on the principal power switch (**PRINCIPAL POWER SWITCH**) on the rear panel, as shown in Figure 2–26. The orange LED on the front panel lights.

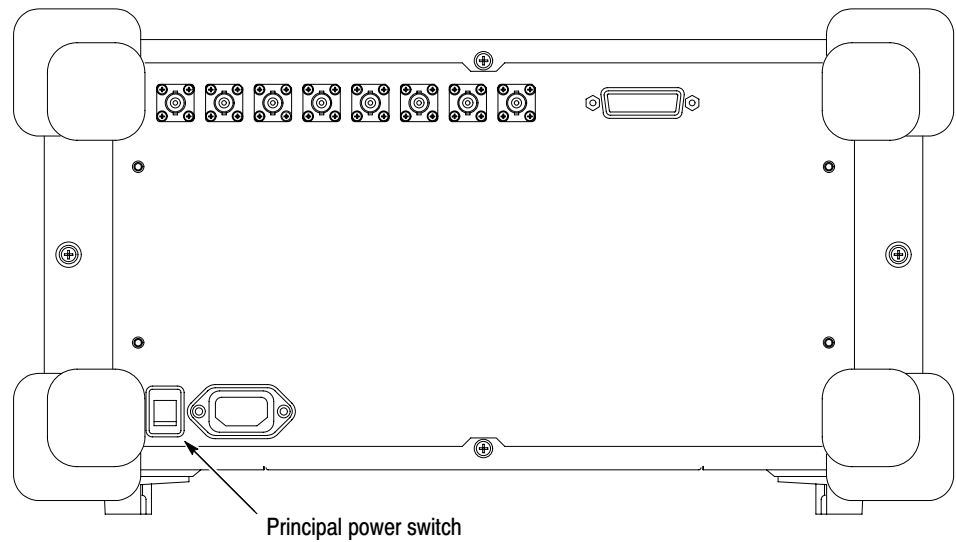
**Figure 2-26: Principal power switch (rear panel)**

3. Turn on the power switch (**ON/STANDBY**) on the front panel, as shown in Figure 2–27.

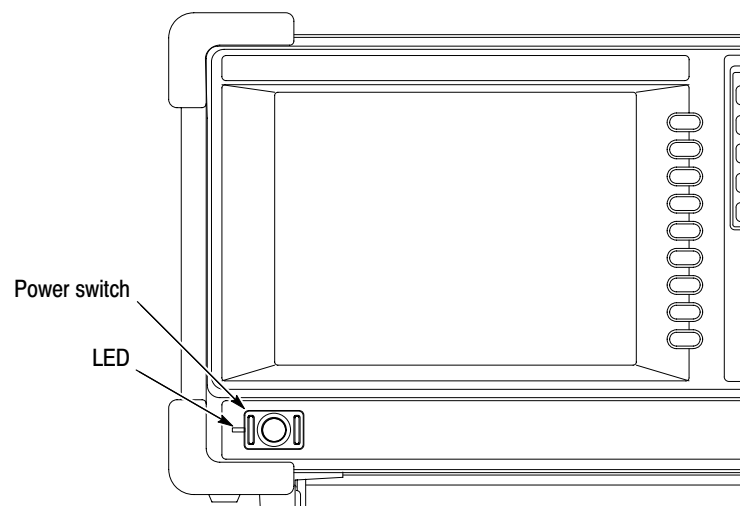
**Figure 2-27: Power switch (ON/STANDBY)**

The initial screen shown in Figure 2–28 appears after Windows 98 starts up (the background color is in white on this manual to make figures more viewable).

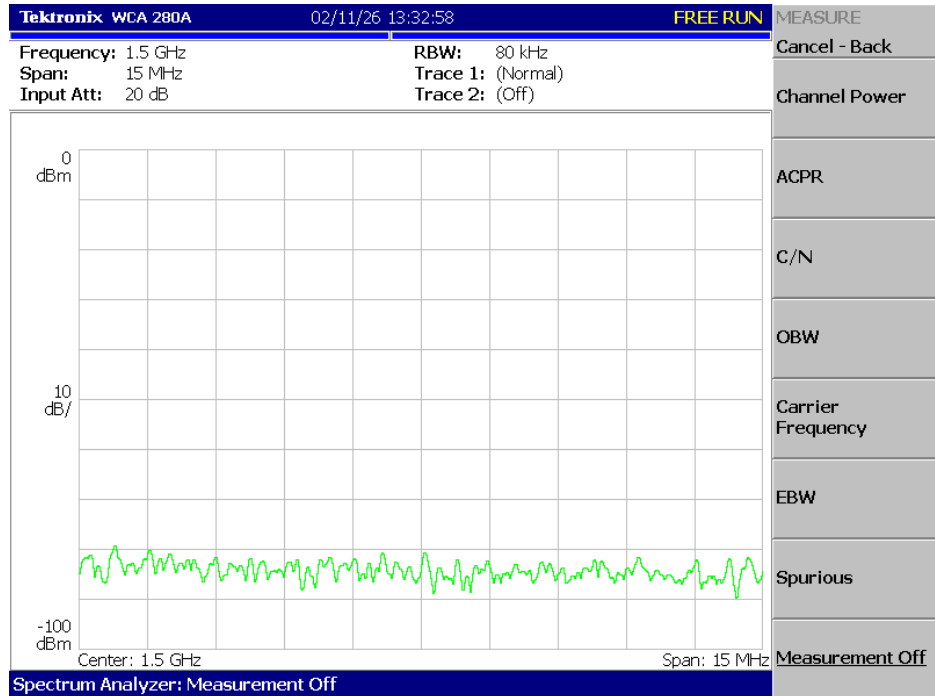

Figure 2–28: Initial screen

Restoring Default Settings

The analyzer saves the settings when it is turned off. When you turn on the analyzer, it starts with the settings as they were when the analyzer was shut down.

This tutorial starts with the factory default settings. Perform the following steps to restore the factory default settings:

1. Press the **SYSTEM** key.

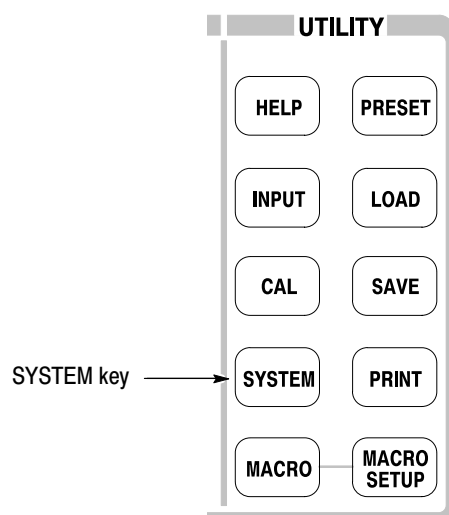

2. Press the **Reset All to Factory Defaults** side key.

The instrument is now ready to take measurements.

Displaying Spectrum

This section describes how to set the frequency, span, and amplitude first, and then appropriately display the spectrum. Figure 2–29 shows the settings.

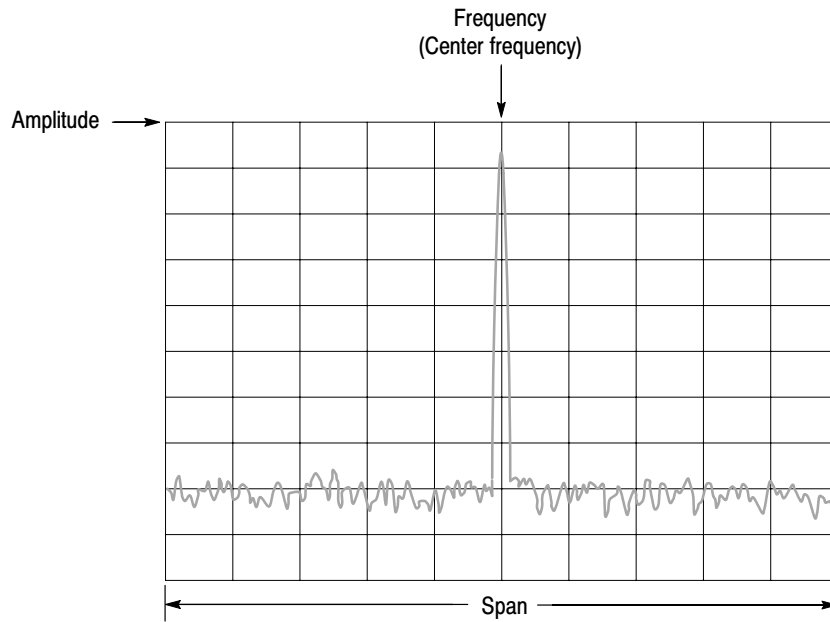
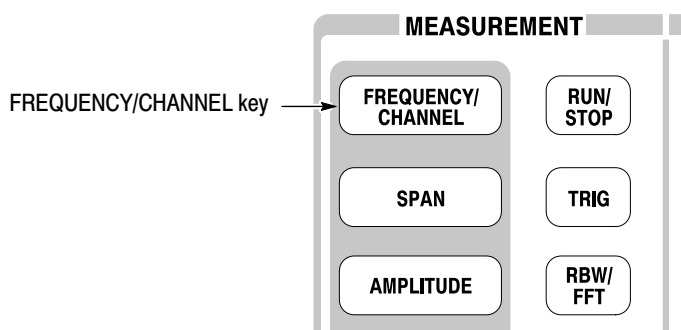

Figure 2–29: Frequency, span, and amplitude settings

Setting Center Frequency and Span

The center frequency is set to 1.5 GHz, and span is set to 15 MHz when you power on the analyzer. Change the settings of center frequency and span to display the waveform around 800 MHz.

1. Press the **FREQUENCY/CHANNEL** key on the front panel.



The **FREQUENCY/CHANNEL** menu, shown in Figure 2–30, is displayed on the right side of the screen. Notice that the Frequency menu item is available for entering the numeric value for center frequency.

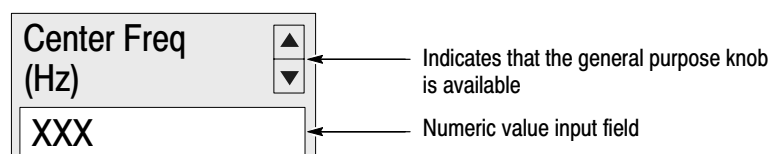

Figure 2–30: Menu items for numeric value input

You can change the value using the general purpose knob or enter the value using the numeric value entry keypad, shown in Figure 2–31.

2. Enter the new center frequency at 800 MHz. As the interval between 1.5 GHz (current setting) and 800 MHz is wide, it is more convenient to use the keypad here.

Press **8 0 0 MHz**, in order, on the keypad.

The **GHz**, **MHz**, **kHz**, and **Hz** keys also function as the enter key. When you press any of these keys, the numeric value you enter will be set immediately.

If you enter incorrect values, clear them using the **BKSP** (back space) key and then enter the correct digit.

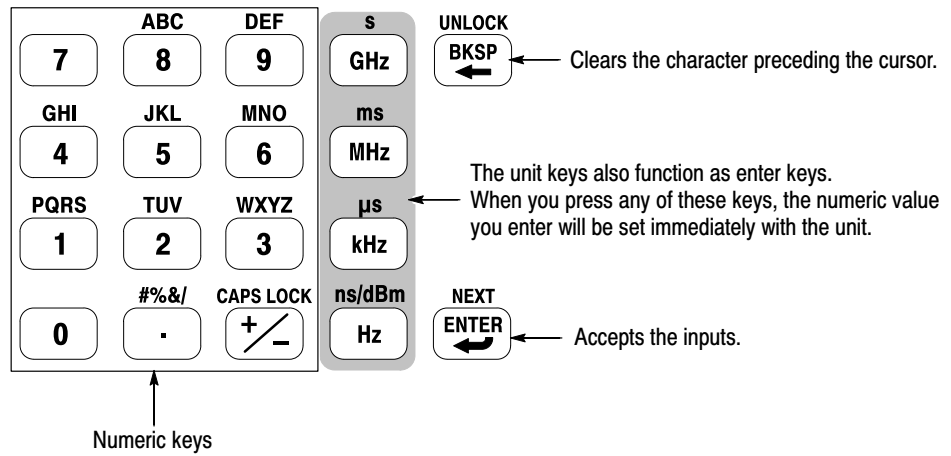

Figure 2-31: Numeric value entry keypad

The spectrum waveform is displayed on the screen as shown in Figure 2-32. The current setting is displayed on the bottom of the screen (“Center Freq (MHz): 800” in this example).

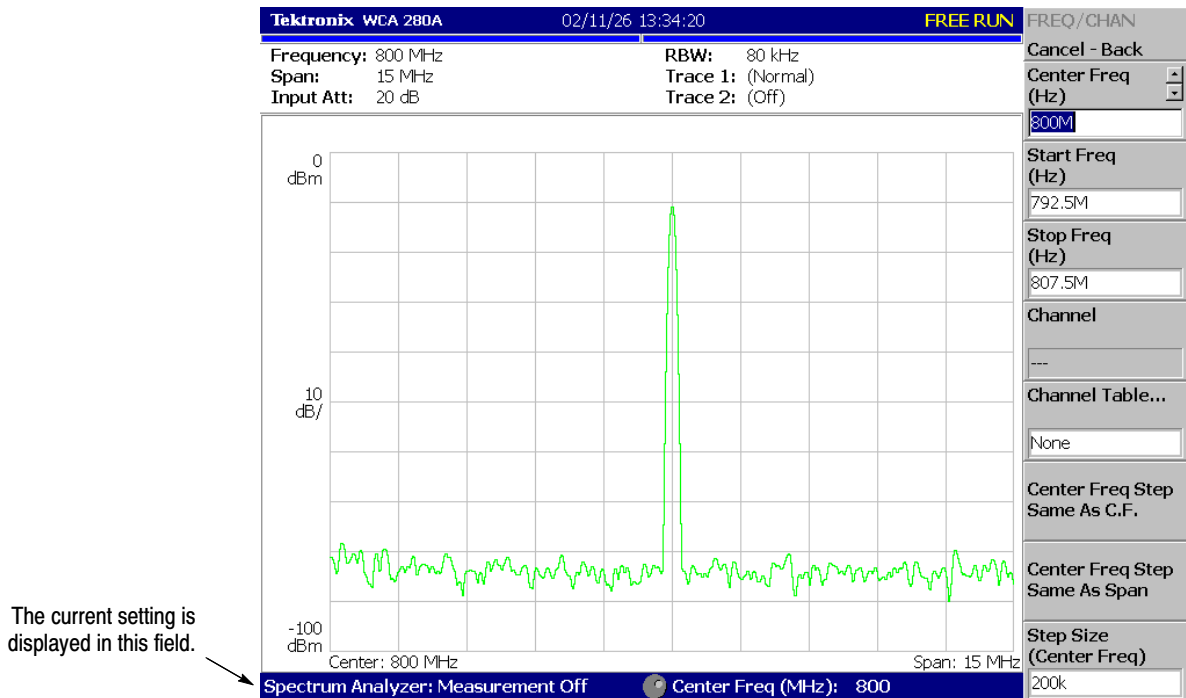
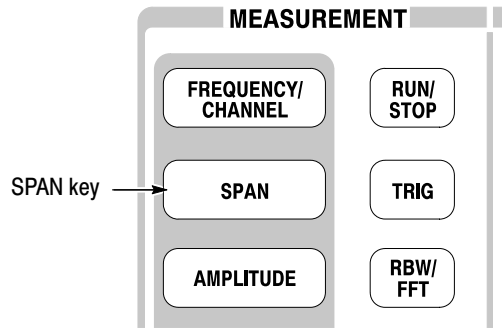

Figure 2-32: Center frequency of 800 MHz, span of 15 MHz

The next step is to set the span, which is currently set to 15 MHz as the default value.

3. Press the **SPAN** key on the front panel.



The **Span** menu item is selected.

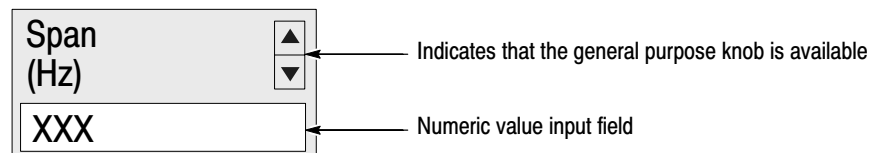

4. Turn the general purpose knob to the left to select **100k**. The hardware is set with the selected value immediately.

The spectrum waveform is displayed on the screen as shown in Figure 2–33.

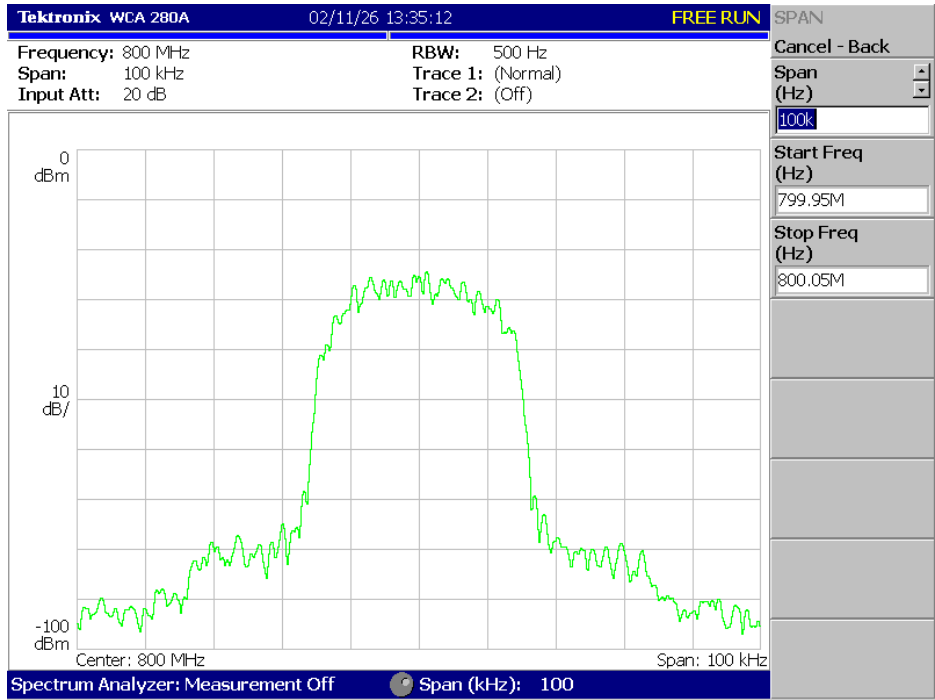

Figure 2-33: Center frequency of 800 MHz, span of 100 kHz

Setting Up Amplitude

In Figure 2–34, the vertical scale shows the spectrum view, set up for 10 dB per division. Ref level is the maximum value of the vertical axis, and it is set to 0 dBm when the analyzer is powered on. Observe the change in the waveform as you change this setting in the following procedure:

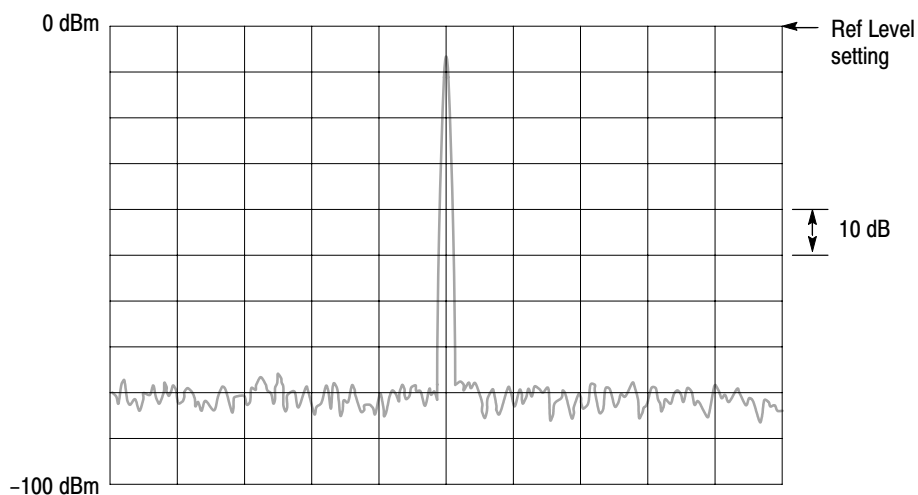
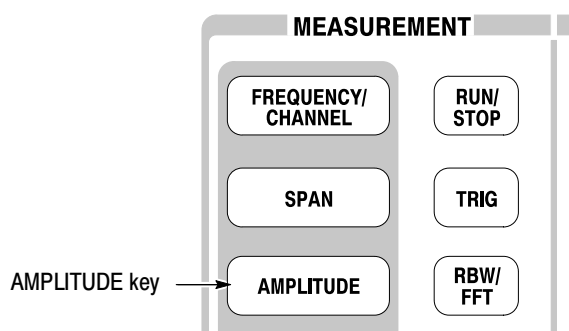

Figure 2–34: Setting amplitude

1. Press the **Amplitude** key on the front panel.



The Amplitude menu is displayed on the right side of the screen. Notice that the Ref Level item is available for entering amplitude (see Figure 2–35).

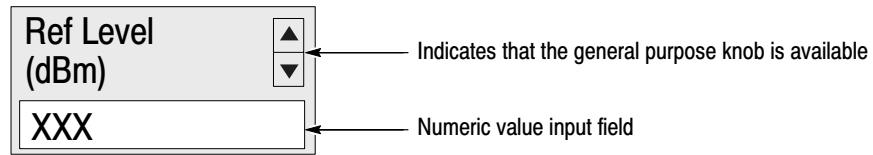

Figure 2-35: Menu items for numeric value input

2. Observe the changes in the waveform as you turn the general purpose knob.
 - As you turn the knob to the right, the amplitude increases and waveform shifts to a relatively lower position.
 - As you turn the knob to the left, the amplitude decreases and waveform shifts to a relatively higher position.

In Figure 2–36, the amplitude is set to 10 dBm. When the amplitude is set to 0 dBm or higher, a blue standard line is displayed indicating 0 dBm.

3. Set the Ref Level back to 0 dBm after confirming the amplitude operation.

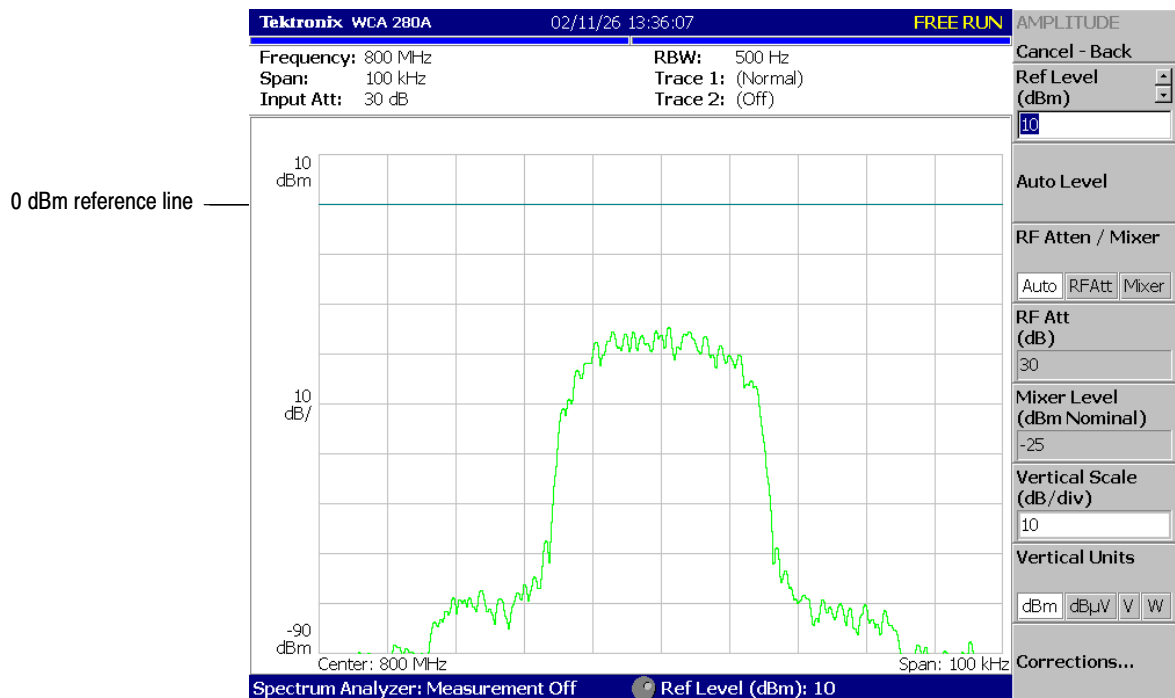
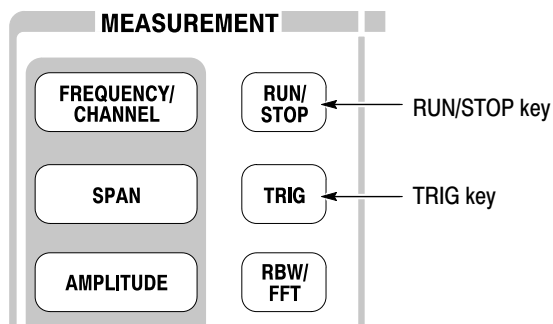

Figure 2-36: Reference level of 10 dBm

Starting and Stopping Data Acquisition

Use the **RUN/STOP** key to start or stop data acquisition. There are two acquisition modes: the continuous mode, in which data is acquired repeatedly and the single mode, in which one waveform is acquired. You can select the mode using the Trig menu.



By default, the analyzer is now acquiring data in the continuous mode.

1. Press the **RUN/STOP** key to stop data acquisition.

When acquisition stops, "PAUSE" is shown in the status indicator on screen (see Figure 2–37).

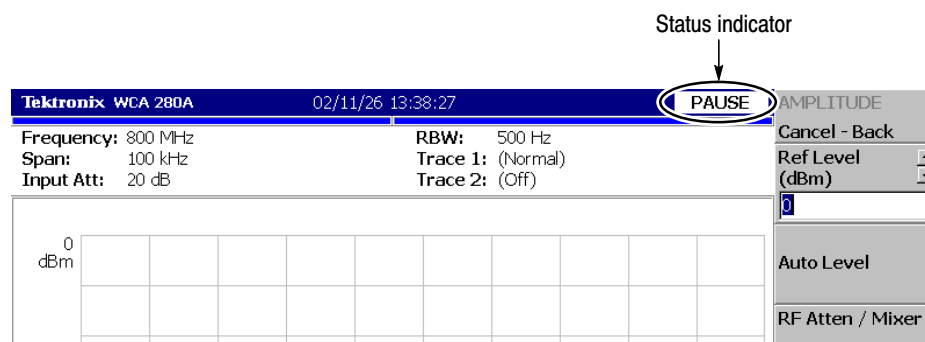

Figure 2–37: Status indicator

2. Acquire data in the single mode using the following steps:
 - a. Press the **TRIG** key on the front panel.
 - b. Press the **Repeat...** side key and select **Single**.
 - c. Press the **RUN/STOP** key to acquire data. One waveform is acquired and displayed every time you press the key.
3. Press the **Repeat...** side key again and select Continuous to return to the continuous mode.

When acquisition starts, “READY” is displayed in the status indicator, indicating that the analyzer is ready for trigger.

Using Markers and Peak Search

The markers are used to measure amplitude or frequency (and also to find the peak signal).

One or two markers can be displayed as Marker 1 and 2. To measure an absolute value, only Marker 1 is used, and that is called “single marker mode.” To measure a relative value, Markers 1 and 2 are used, and that is called “delta marker mode.” To position the markers, use the general purpose knob or the numeric input keypad.

Measuring with a Single Marker

1. Press the **MARKER SETUP** key on the front panel.

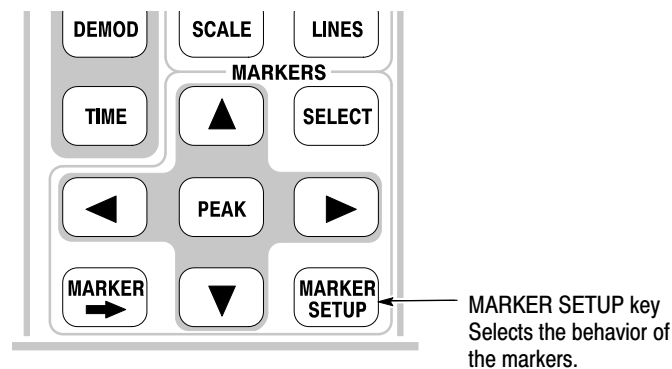

2. Press the **Markers** side key to select **Single**.

The marker (□) appears at the left end of the waveform.

3. The **Marker X Position** menu item is selected by default. Turn the general purpose knob to move the marker to a measurement point (see Figure 2–38).

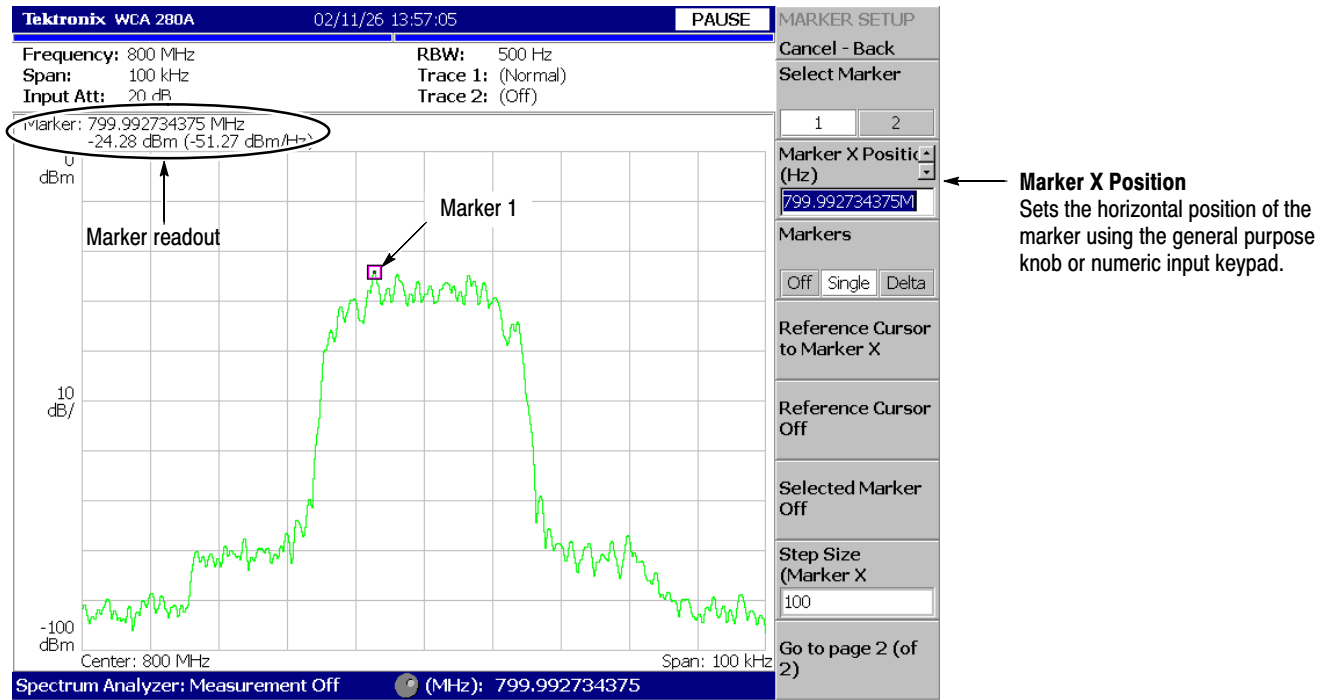

Figure 2-38: Measurement with a single marker

Measuring Difference with Delta Marker

Turn on Marker 1 and 2 to measure the difference in amplitude and frequency. On the screen, the symbol “□” represents the active marker and “◇” represents the fixed marker. You can operate only the active marker.

1. Press the **MARKERS SETUP** key on the front panel.
2. Press the **Markers** side key to select **Delta**. The fixed marker (◇) appears at the left end on the waveform.
3. Make sure that **1** (Marker 1) is selected in the **Select Marker** menu item. This means that Marker 1 is the active marker.
4. The **Marker X Position** menu item is selected. Using the general purpose knob or the numeric input keypad, move the marker to a reference point (see Figure 2–39).
5. Press the **Select Marker** side key to select **2**, making Marker 2 the active marker.

You can also select the marker using the **MARKERS SELECT** key on the front panel. The **MARKERS: SELECT** key and the **Select Marker** side key have the same function.

- The **Marker X Position** menu item is selected. Using the general purpose knob or the numeric input keypad, move the marker to a measurement point (see Figure 2–39).

The difference between the two marker positions is indicated in the upper left part of the screen.

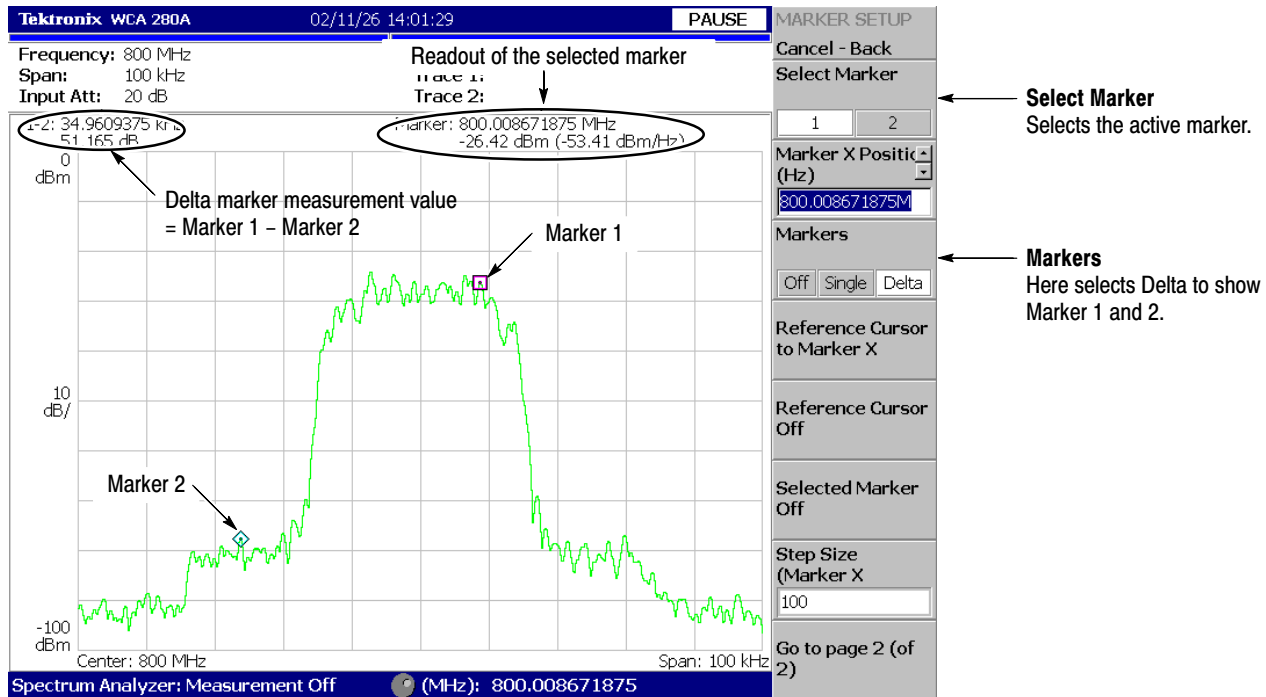

Figure 2–39: Measurement with the delta marker

- Press the **Markers** side key to select **Single**. The analyzer returns to the single marker mode.

Searching for the Peak

Measure the frequency interval between the maximum intensity spectrum and the peak to its left by using the delta marker and peak search functions together.

1. Press the **PEAK** key on the front panel.

Marker 1 moves to the maximum intensity spectrum.

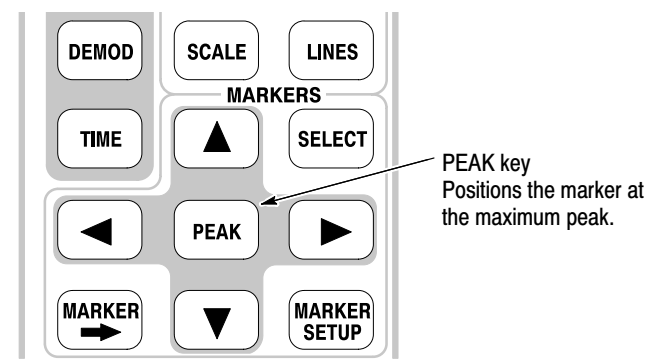

2. Press the **Markers** side key to select **Delta**.

The fixed marker (\diamond) appears at the point that was last set.

3. Press the **Select Marker** side key to select **2**, making Marker 2 active.
4. Press the marker right key (\blacktriangleright) to move the marker to the next signal peak to the right. Try it several times.
5. Press the marker left key (\blacktriangleleft) to move the marker to the next signal peak to the left. Try it several times.
6. Using the marker left or right key, position the marker to the measurement peak.

The difference between the two marker positions is shown in the upper left part of the screen (see Figure 2–40).

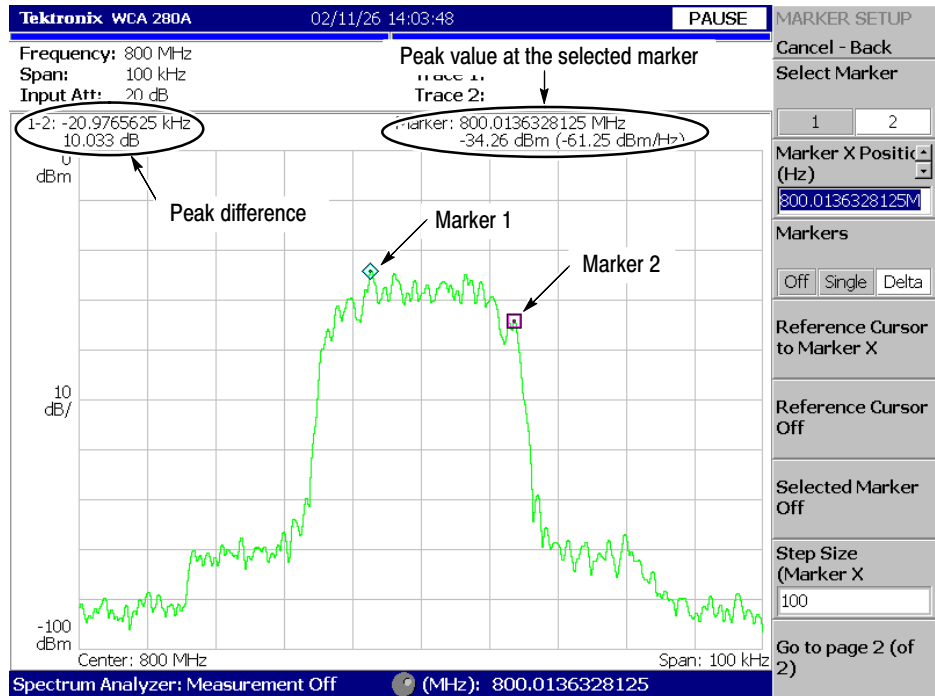

Figure 2–40: Searching for the peak

7. Press the **Markers** side key to select **Off**. Both markers disappear.

Using Averaging and Comparison Displays

This section describes how to use the averaging function, which displays the waveform with reduced noise. The averaged waveform can be displayed with the original waveform.

Averaging

There are several averaging methods; select RMS (Root-Mean-Square) in this example.

1. Press the **TRACE/AVG** key.

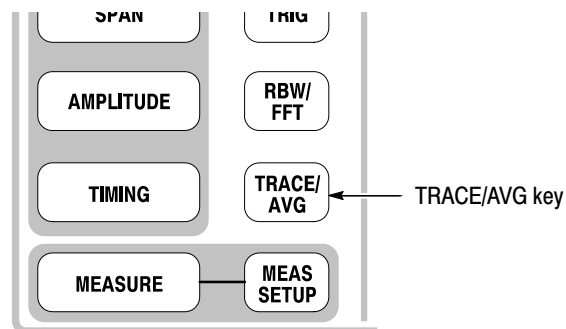

2. Press the **Trace Type** side key to select **Average**.
3. Press the **Number of Averages** side key to specify how many traces are accumulated to create the averaged waveform.

In this example, enter 64 with the numeric keypad.
Press **6 4 ENTER** in order.

4. Press the **RUN/STOP** key on the front panel to acquire waveform.

The averaged waveform is displayed on the screen. The average count is shown in the upper right part of the screen (see Figure 2–41). When the waveform is acquired in the free run mode, the averaging is done with exponential RMS (root-mean-square). This method continues the average with an exponential weighting applied to old values, using the number of averages (64 in this example) as the weighting factor.

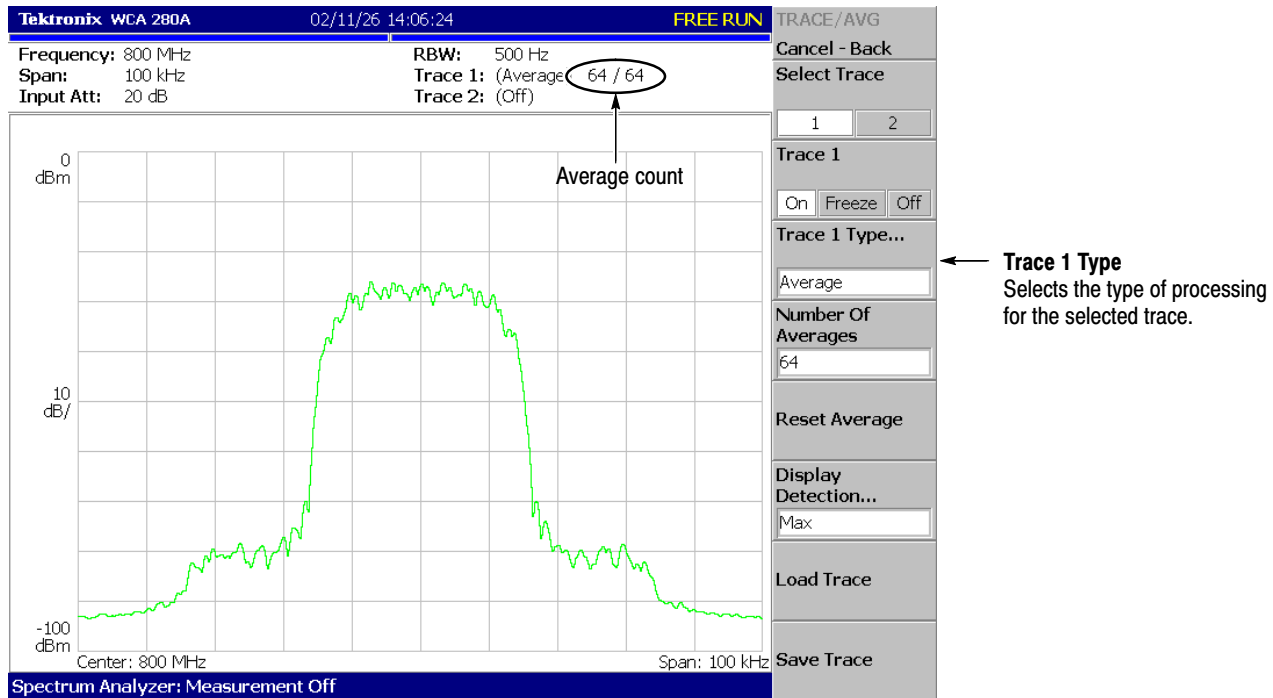

Figure 2–41: Comparing a new waveform with an averaged waveform

5. Press the **Reset Average** side key to restart averaging.

Comparison Display

You can display two different types of traces concurrently on the screen. In this procedure, you will display the currently acquired waveform and an averaged waveform for comparison.

1. Press the **TRACE/AVG** key on the front panel.
2. Make sure that **1** (Trace 1) is selected in the **Select Trace** menu item.
3. Press the **Trace Type...** side key and select **Normal** to define Trace 1 as the currently acquired waveform.
4. Press the **Select Trace** side key to select **2** (Trace 2).
5. Press the **Trace 1 Type...** side key and select **Average** to define Trace 2 as the averaged waveform.
6. Press the **RUN/STOP** key on the front panel to acquire waveform.

The currently acquired waveform (Trace 1 in yellow) is displayed with the averaged waveform (Trace 2 in green). See the display in Figure 2–42.

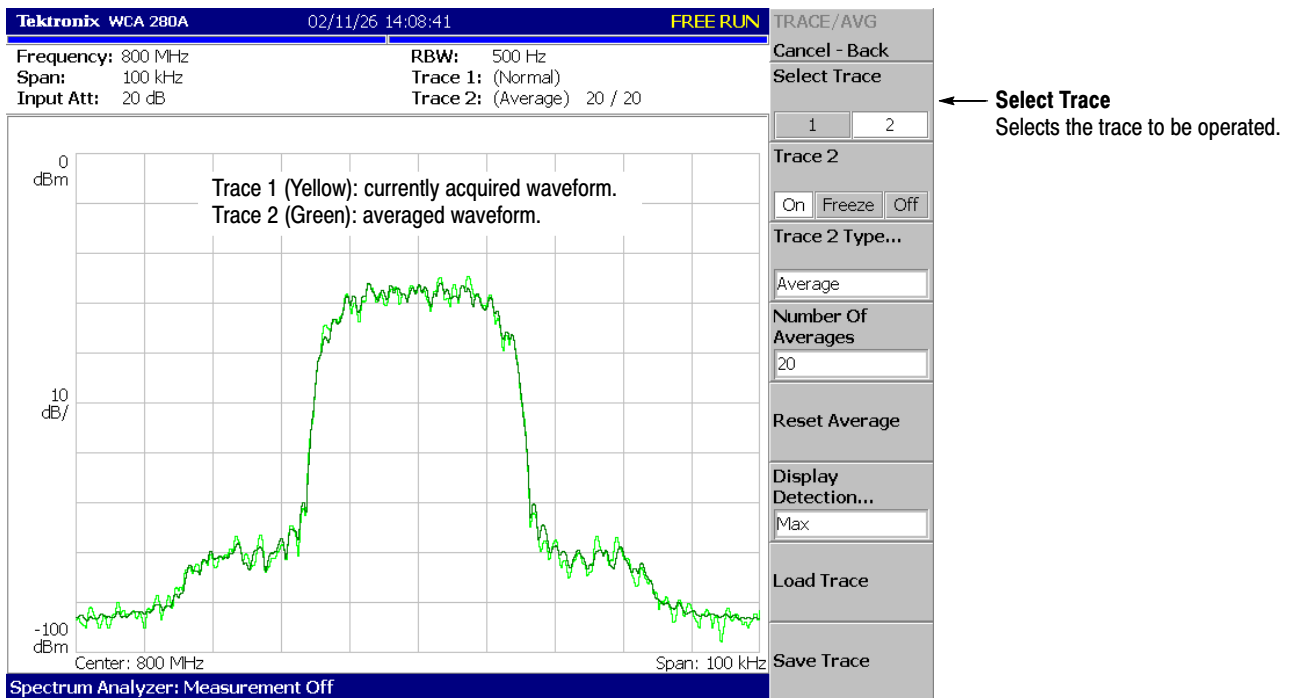

Figure 2–42: Comparison display with averaged waveform

7. Press the **Trace 2 Type...** side key again and select **Off** to remove Trace 2.

Displaying a Spectrogram

The spectrogram view is a useful tool to observe spectrum changes in time series in a three-dimensional view. The horizontal and vertical axes indicate frequency and frame number, respectively, and the color axis represents amplitude.

Display the spectrogram using the following steps:

1. Press the **MODE: S/A** key.

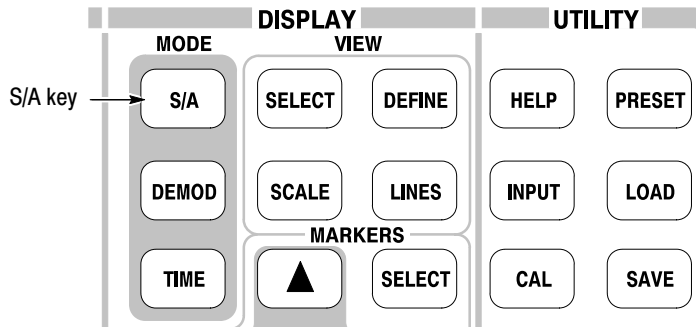

2. Press the **Spectrum Analyzer with Spectrogram** side key.
3. If no waveform is displayed, press the **RUN/STOP** key to acquire data.

The spectrum and spectrogram are displayed concurrently (see Figure 2–43).

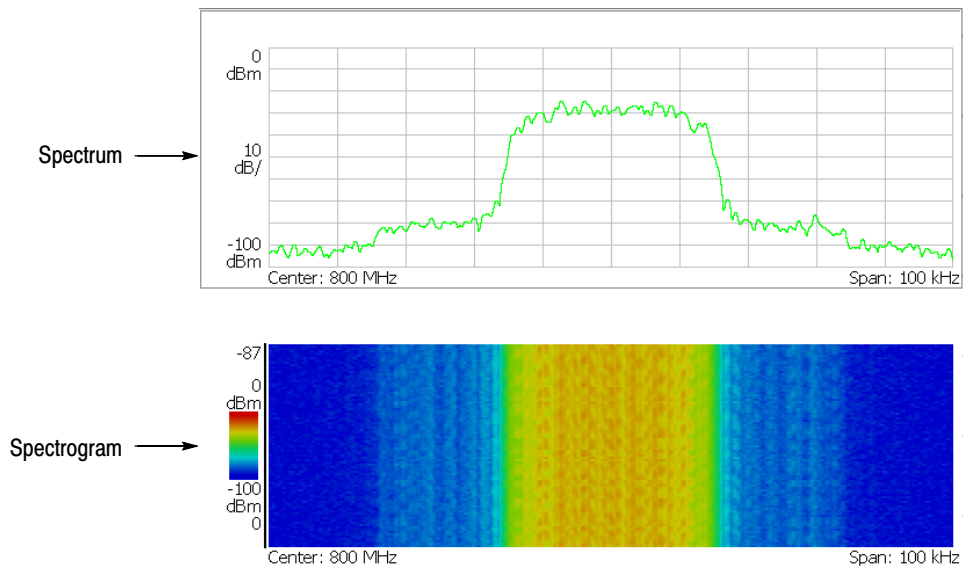
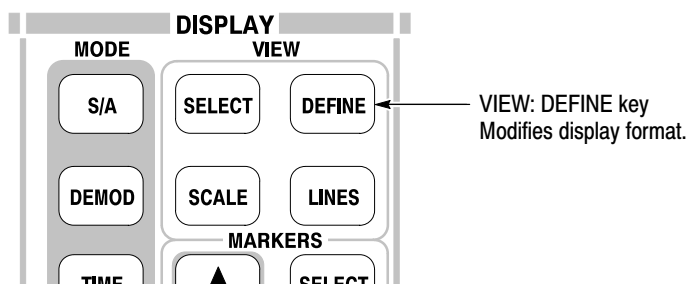

Figure 2–43: Concurrent display of spectrum and spectrogram

4. Display the spectrum and spectrogram side-by-side:
 - a. Press the VIEW: **DEFINE** key.



- b. Press the **View Orientation** side key to select **Tall**.

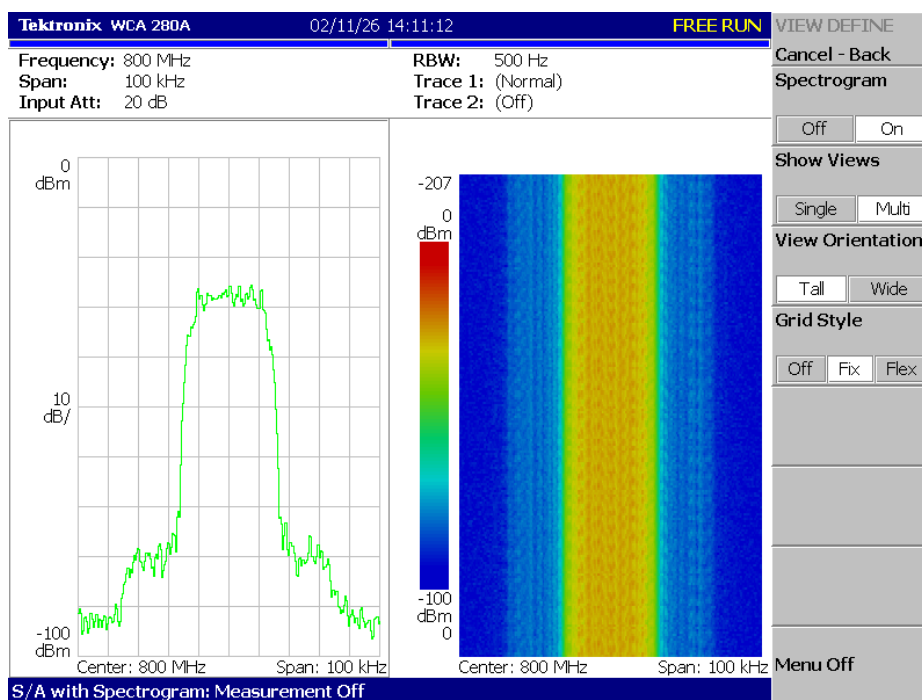

Figure 2-44: Tall display of spectrum and spectrogram

- c. Press the **View Orientation** side key to select **Wide**.

5. Display spectrogram only:

- a. Press the VIEW: **SELECT** key and then select the spectrogram on the display.

The selected view is framed in white on screen.

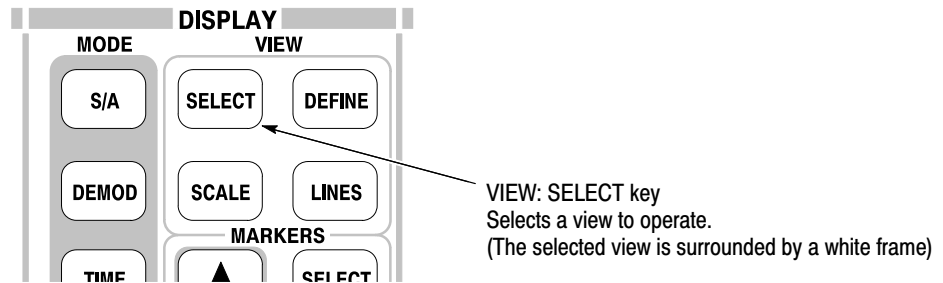

- b. Press the VIEW: **DEFINE** key and then press the **Show Views** side key to select **Single**.

Only the spectrogram is displayed (see Figure 2–45).

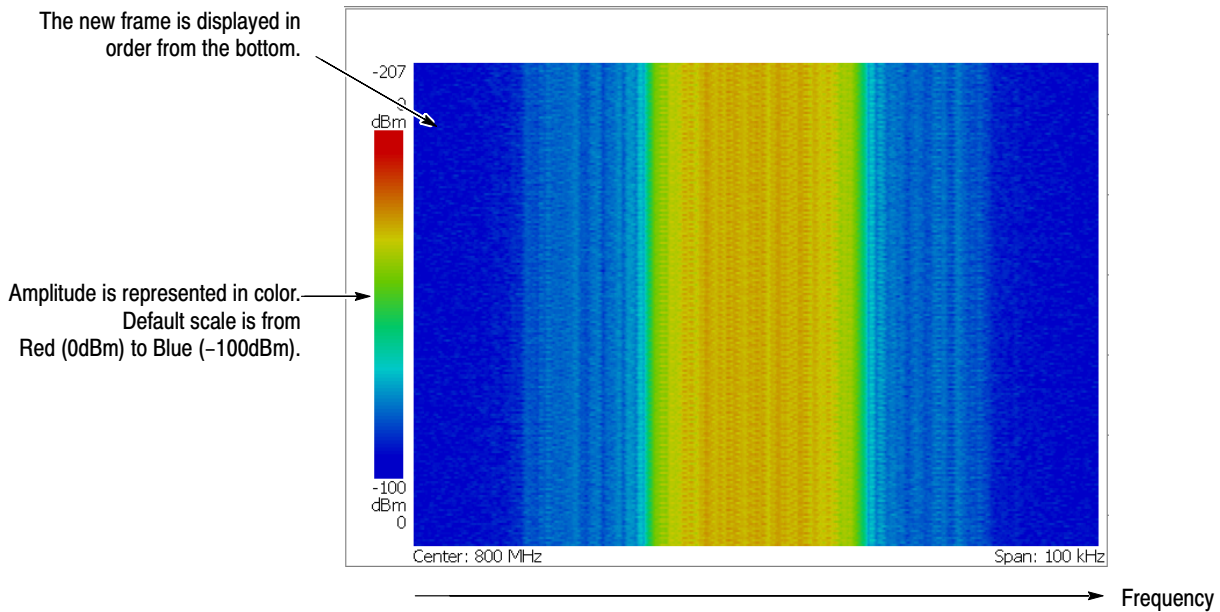

Figure 2–45: Spectrogram view

- c. Press the **Show Views** side key again to return to **Multi**.

Spectrum Analysis

There are several items in the spectrum analysis, such as ACPR (Adjacent Channel Leak Power Ratio), C/N (Carrier vs. Noise Power Ratio), and OBW (Occupied Band Width). These items enable you to perform measurements using simple key operations. Channel power and carrier frequency are measured as examples.

- Measuring Channel Power** 1. Press the **MEASURE** key on the front panel.

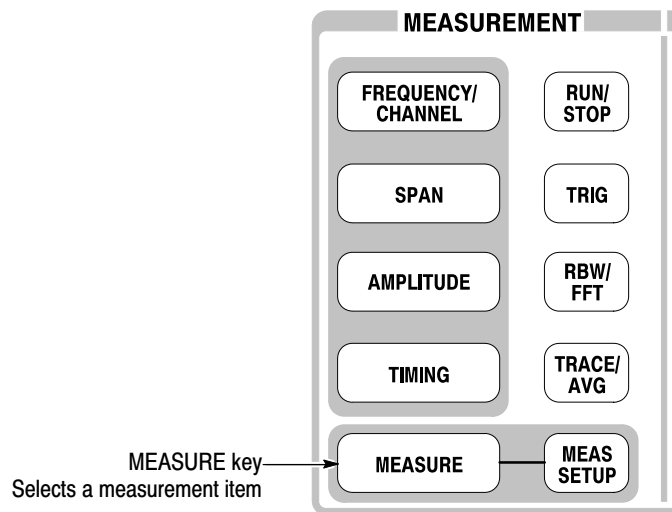

Measurement items are displayed in the menu on the right side of the screen.

2. Press the **Channel Power** side key.

A band power marker, indicating measurement range, is displayed on the spectrum waveform. The measurement result is displayed below the waveform (see Figure 2–46).

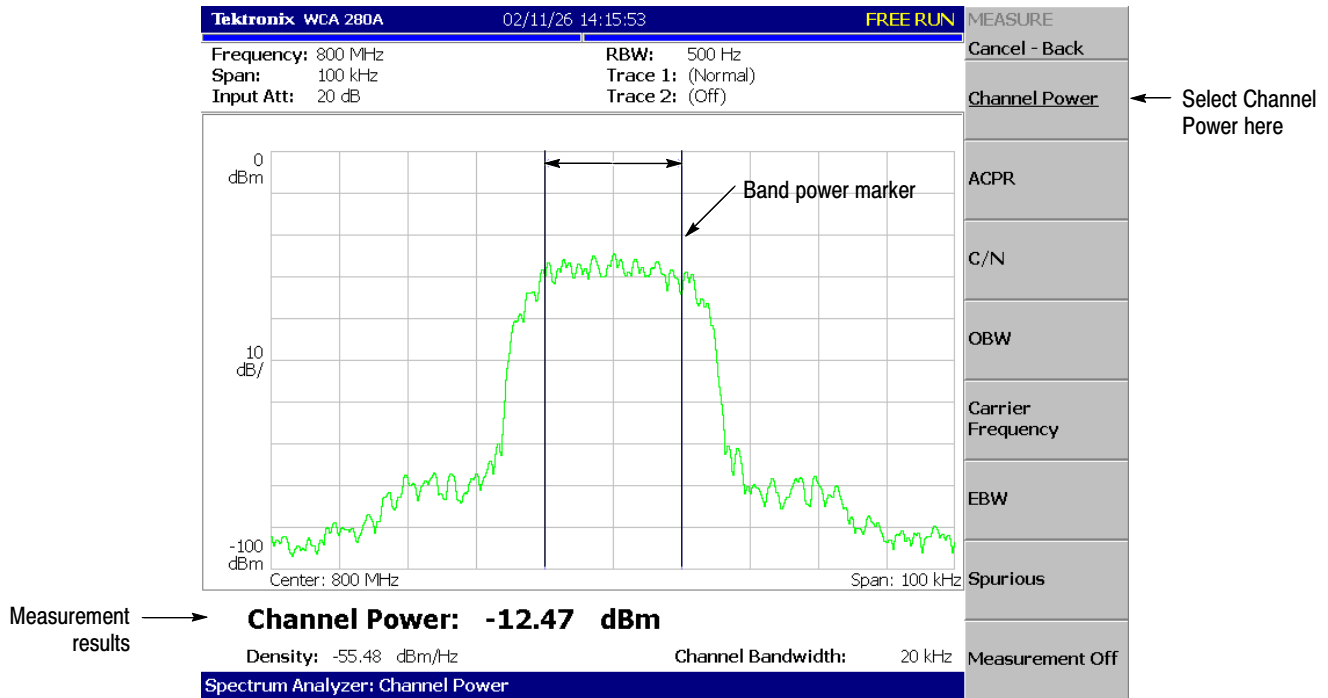

Figure 2–46: Channel power measurement

Changing a Measurement Parameter

Change a measurement parameter:

1. Press the **MEAS SETUP** key on the front panel.
2. The **Channel Bandwidth** menu item is selected. Using the general purpose knob, set the measurement range to 40 kHz for example. See the display in Figure 2–47.

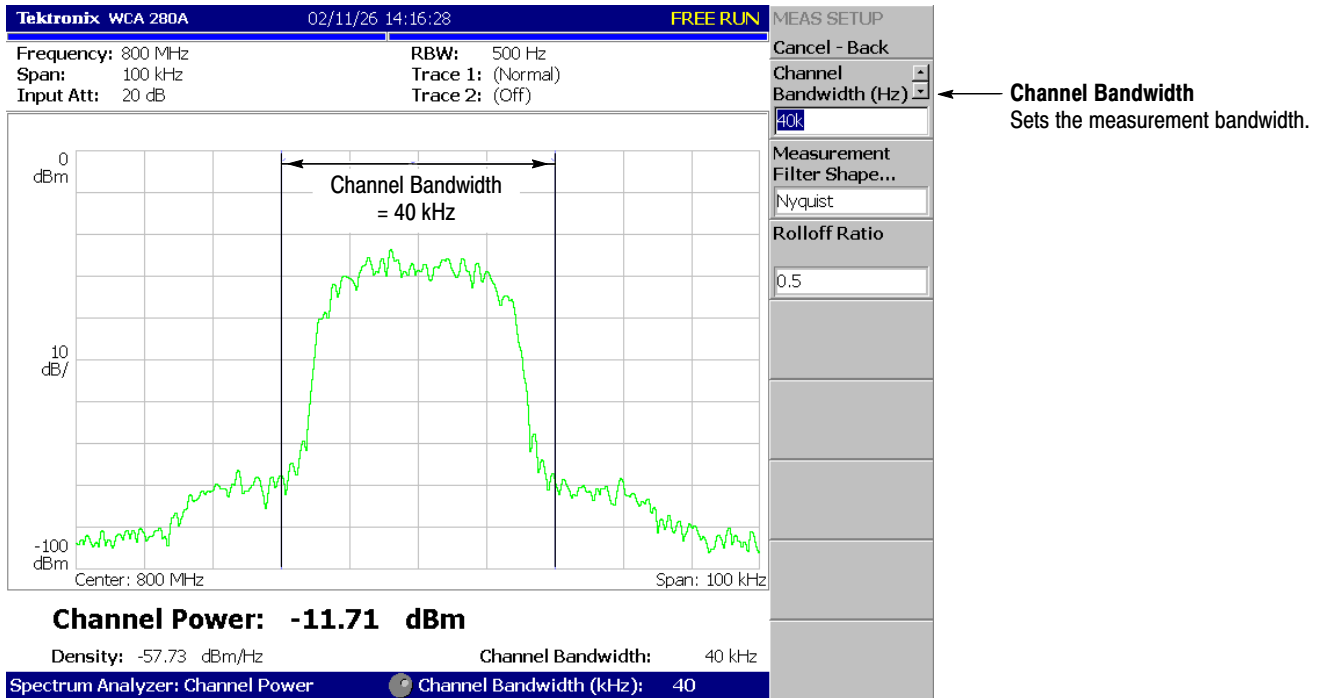

Figure 2–47: Channel power measurement (Channel Bandwidth = 40 kHz)

Measuring Carrier Frequency

Carrier frequency can be measured accurately, using the counter function:

1. Press the **MEASURE** key on the front panel.
2. Press the **Carrier Frequency** side key.

The measurement result is displayed at the bottom of the screen (see Figure 2–48).

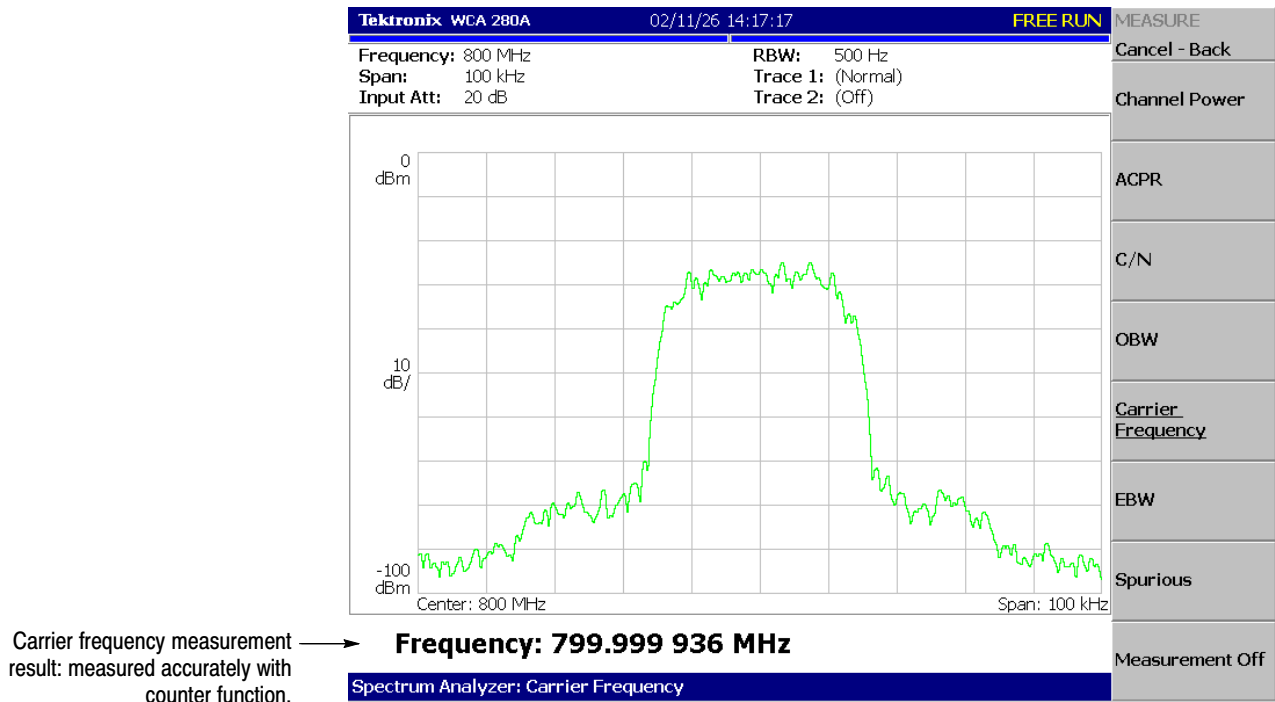

Figure 2–48: Carrier frequency measurement

Modulation Analysis

This section describes how to analyze a digitally-modulated signal. Settings are the same as those in the previous section; center frequency at 800 MHz, span of 100 kHz, and amplitude of 0 dBm.

Selecting Analysis Mode

The analyzer functions are classified into three functional groups, selected using the Mode keys (see Figure 2–49):

- Spectrum analysis **MODE: S/A**
Performs general spectrum analysis. All operations in the tutorial up to this point have been performed in this mode.
- Modulation analysis **MODE: DEMOD**
Performs analog and digital modulation analysis.
- Time analysis **MODE: TIME**
Performs time characteristic analysis, including CCDF measurement.

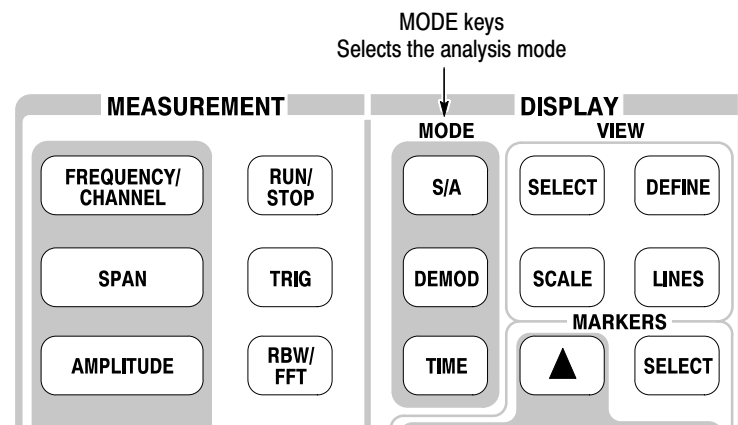

Figure 2–49: MODE keys

The measurement procedures for modulation analysis and the time analysis are similar. Select the digital modulation analysis:

1. Press the **DEMOM** key on the front panel.
2. Press the **Measurement Set** side key to select **Digital**.

Selecting a Measurement Item

Observe IQ level change in time series as an example.

1. Press the **IQ/Frequency vs. Time** side key.
2. Press the **MEAS SETUP** key on the front panel to set the measurement parameter.
3. Because this tutorial uses the PDC modulation signal, press the **Parameter Presets...** side key and select **PDC**.
4. Press the **RUN/STOP** key to acquire the signal (see Figure 2–50).

Three views are displayed on the screen in the Demod mode:

- *Overview:* All data of the specified block are displayed in the time domain. The measurement range indicated by the green underline is specified in this view.
- *Main view:* Displays the measurement result and waveform of the range specified in the overview (they may be displayed in separate views). In this case, level changes of I and Q signals are displayed as the yellow and green traces, respectively, in the main view.
- *Subview:* Spectrum is displayed as an auxiliary view by default. You can specify the range in the overview to create the spectrum for the subview.

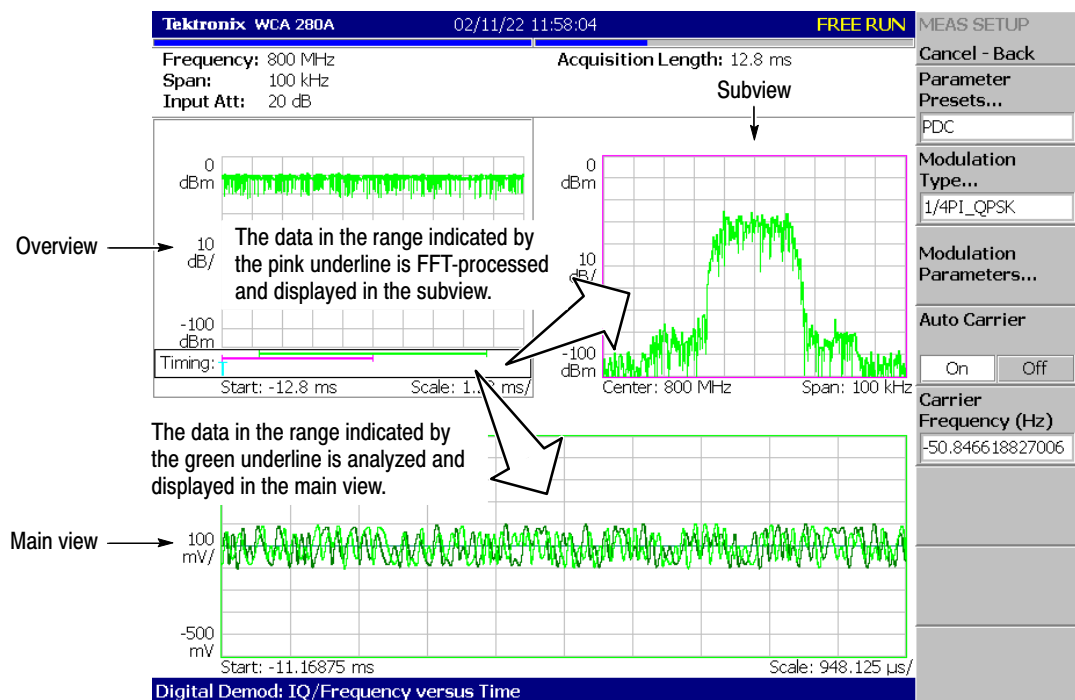

Figure 2–50: IQ level measurement

Setting Analysis Range

Set an analysis range, which will be displayed with a green underline in the overview.

1. Press the **TIMING** key on the front panel.

Two vertical green lines appear, indicating the analysis range, shown in Figure 2–51.

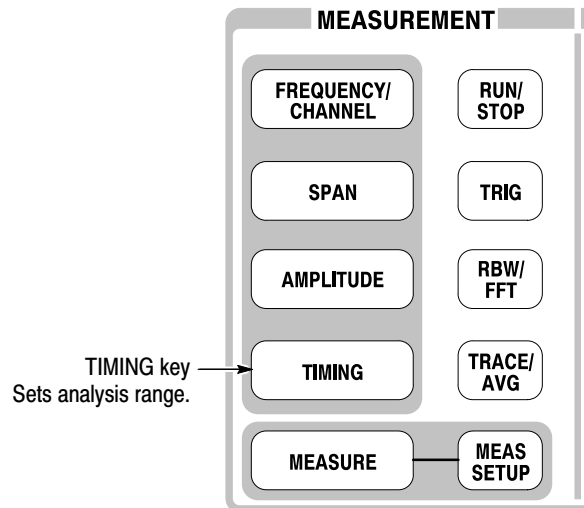

2. Press the **Acquisition History** side key to specify the number of the block to be analyzed. Leave it at “0” (the latest block), its default value.
3. Press the **Analysis Length** side key and specify the time length of the analysis range. For example, enter **8 ms** using the numeric keypad.
4. Press the **Analysis Offset** side key and specify the starting point of the range. For example, enter **3 ms** using the numeric keypad.

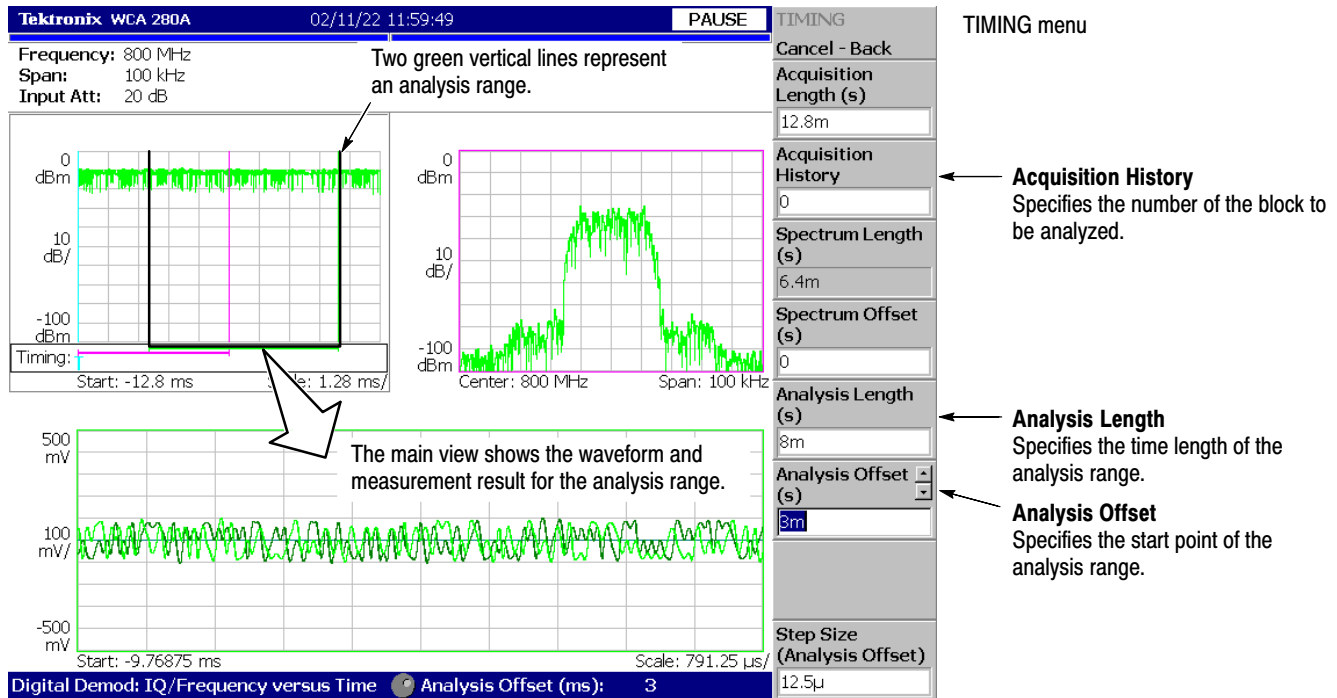

Figure 2-51: Analysis range settings

Setting the Acquisition Length

One frame consists of 1024 data points and one block consists of several frames. Data are acquired in block units in the Demod mode. The number of frames in one block is referred to as block size. Frame and block size are shown in Figure 2-52.

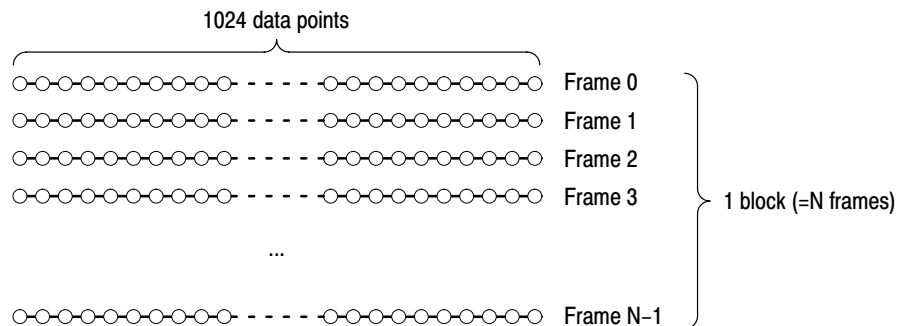

Figure 2-52: Frame and block

Suppose that one block contains N frames. The acquisition length for a block is calculated using this equation:

$$(\text{One block acquisition length}) = N \times (\text{One frame acquisition length})$$

One block acquisition length is set using **Acquisition Length** in the Timing menu. One frame acquisition length is set internally, depending on span, and displayed in **Spectrum Length** in the Timing menu.

To set the acquisition length, perform the following steps:

1. Press the **TIMING** key on the front panel.

By default, Acquisition Length is set to 12.8 ms and Spectrum Length 6.4 ms. The number of frames in a block is $12.8 \div 6.4=2$.

2. Press the **Acquisition Length** side key to change the value.
For example, set 64 ms by turning the knob (see Figure 2–53).

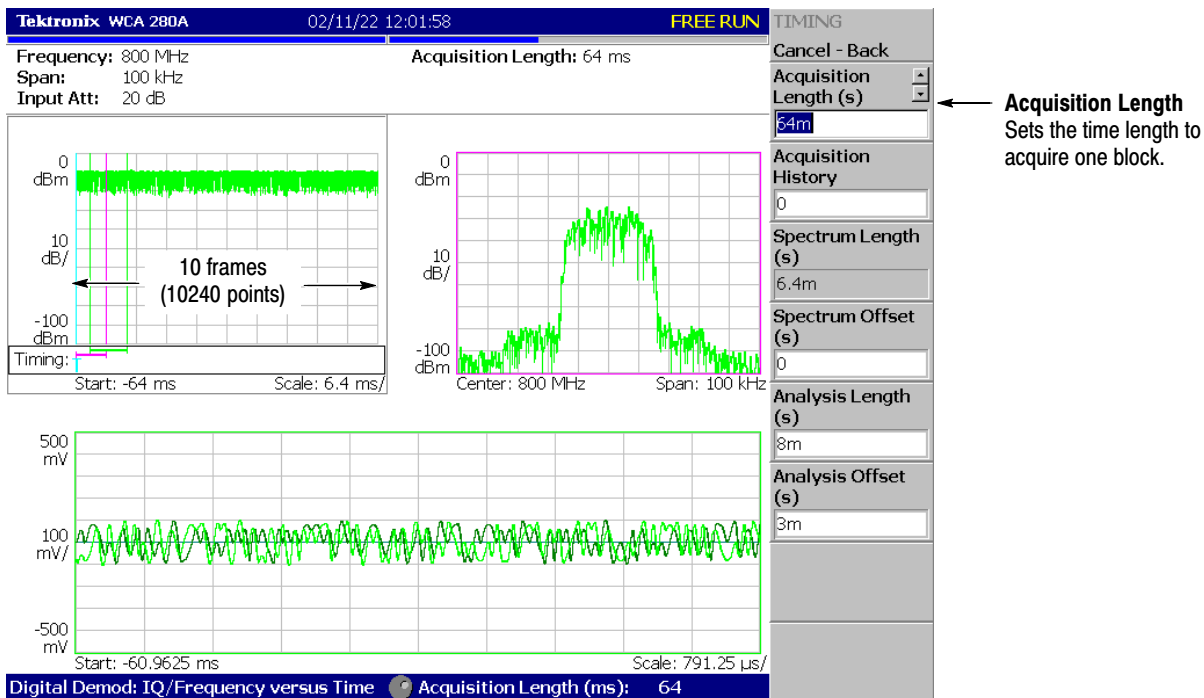

Figure 2–53: Changing the acquisition length

In this case, Acquisition Length is 64 ms and Spectrum Length 6.4 ms, so the data is displayed in the overview for $64 \div 6.4=10$ frames (10240 points). The green underline indicating the analysis range gets narrower than the previous setting: one block = 2 frames.

Displaying Single View and Changing Scale

Although three views are normally displayed in the Demod mode, you can select one view to display full screen. This section describes how to display one view and change the vertical and horizontal scales using the VIEW keys.

1. Press the **RUN/STOP** key to stop acquisition and observe the waveform.
2. Press the **VIEW: SELECT** key to select the main view. The selected view is surrounded with a white frame.

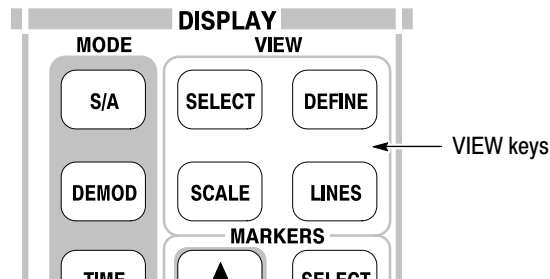

3. Press the **DEFINE** key, and then the **Show Views** side key, shown in Figure 2–54, to select **Single**.

Only the main view is displayed, with the size enlarged on the screen.

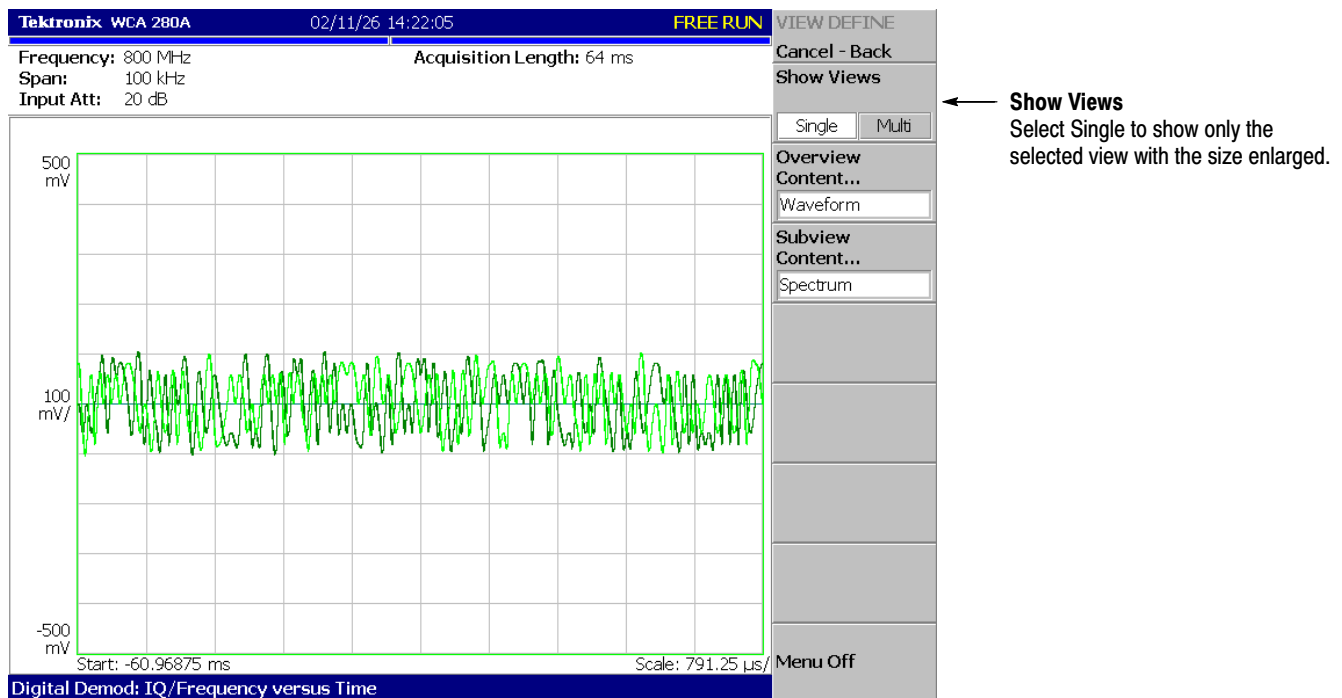

Figure 2–54: Single view display

4. Change the scale:
 - a. Press the **SCALE** key in the VIEW area.
 - b. Press the **Horizontal Scale** side key and change the scale of the horizontal axis (see Figure 2–55). Try several settings by turning the general purpose knob; observe the changes in the display.
 - c. Press the **Vertical Scale** side key and change the vertical axis scale. Try several settings by turning the knob; observe the changes in the display.

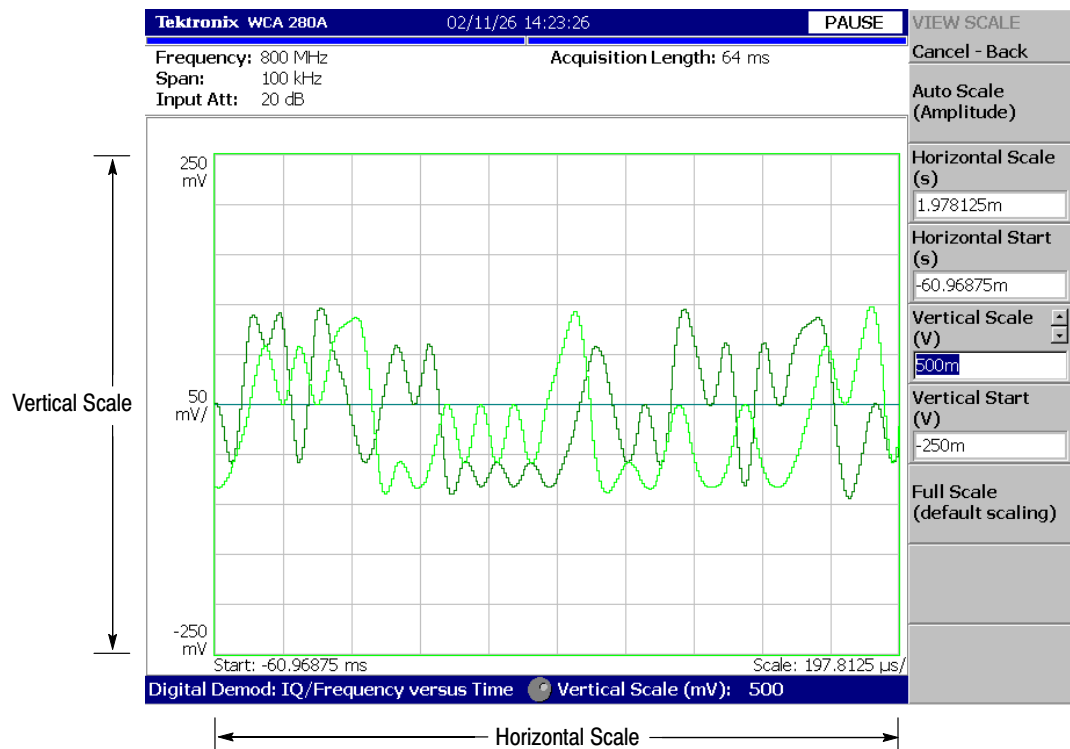

Figure 2–55: Scale settings

Completing the Measurement

Complete the measurement with the following procedure:

1. Press the **MEASURE** key on the front panel.
2. Press the **Measurement Off** side key.

The display returns to the spectrum view. However, the analysis mode is still in the Demod mode.

Turning Off the Power

When you have completed the measurements, turn off the power:

1. Press the **ON/STANDBY** switch at the lower left of the front panel.

The shutdown process of Windows 98 runs and the power source goes to standby state, with the orange LED on.

2. Turn off the signal generator.

You have now completed the tutorial.

Reference

Spectrum Analysis (S/A Mode)

This section describes the measurement methods available in spectrum analysis (S/A) mode.

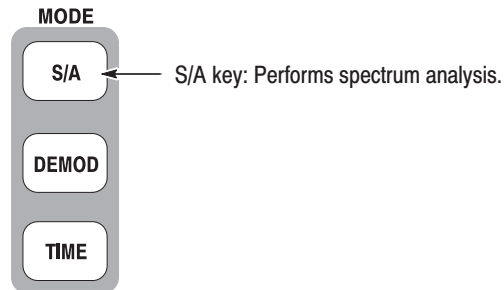

There are four items in the S/A menu:

- **Spectrum Analyzer:** Performs general spectrum analysis. Refer to page 3–4 for details.
- **S/A with Spectrogram:** Performs spectrum analysis displaying spectrogram. Refer to page 3–20 for details.
- **Real Time S/A:** Performs real-time spectrum analysis with spectrogram. Refer to page 3–22 for details.
- **Standard...:** Performs spectrum analysis according to a communication standard. For details, refer to the user manual included in each option:

Table 3-1: Standard menu in the S/A mode

Menu item	Option	Description
W-CDMA-DL	Option 22	W-CDMA downlink analysis
W-CDMA-UL	Option 23	W-CDMA uplink analysis

Measurement Screen Layout

Figure 3–1 shows the basic screen layout in the spectrum analysis (S/A mode). The spectrum waveform and measurement results are displayed. You can display spectrum with spectrogram at the same time. Refer to *Spectrogram Display* on page 3–20.

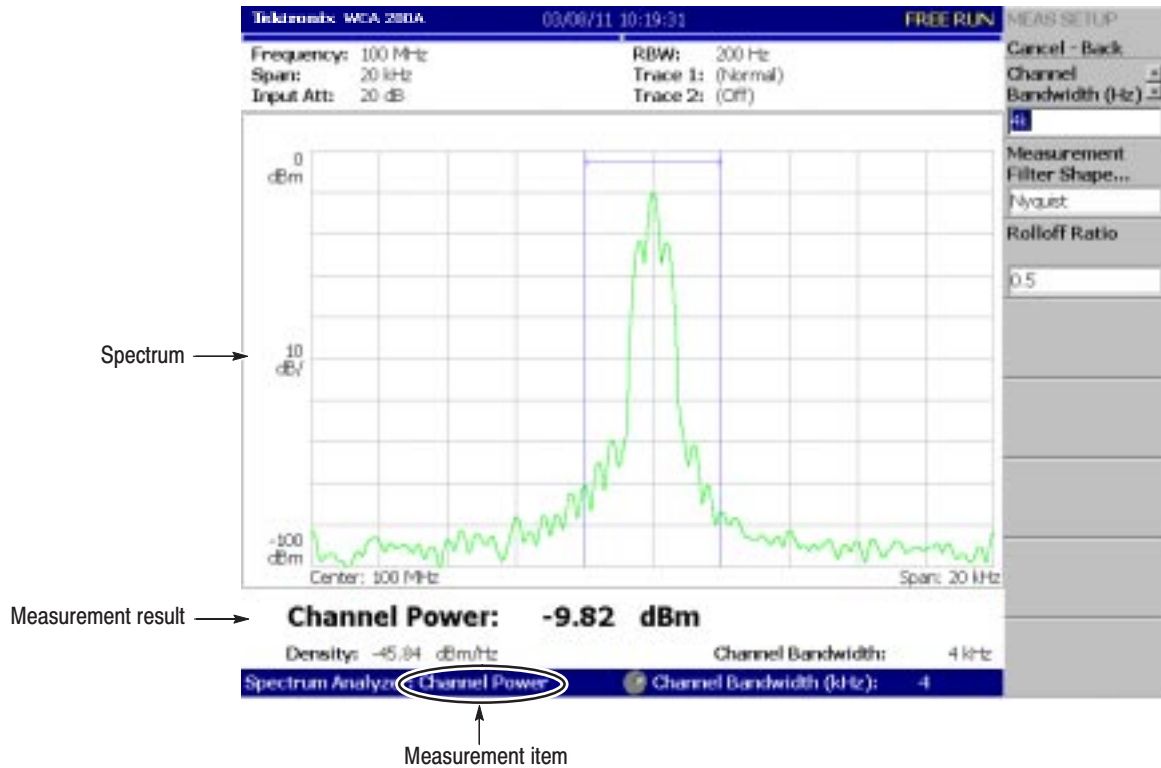

Figure 3–1: S/A measurement screen

Changing the Grid Style

The graticule is shown with 10 X 10 grid by default. You can select the grid style by pressing VIEW: **DEFINE** → **Grid Style** as follows:

NOTE. The Grid Style menu item is available in the S/A mode except Real Time S/A.

Off. Turn off the graticule.

Fix. Always displays 10 X 10 grid.

Flex. Displays the graticule with the horizontal scale (per division) in a 1-2-5 sequence.

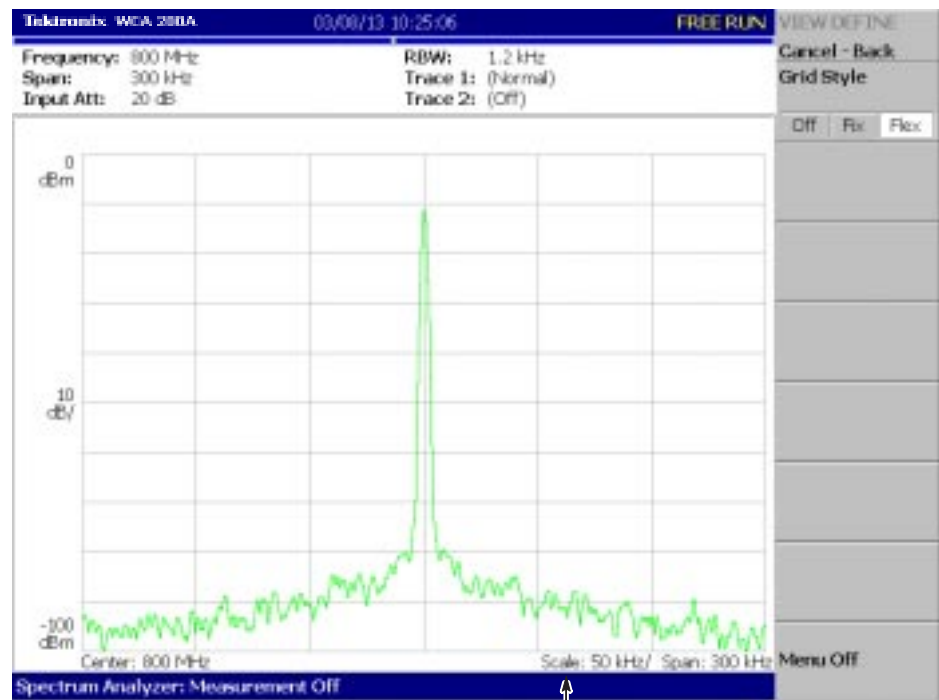

The horizontal scale is set to 50 kHz/div for span of 300 kHz in the "Flex" grid style.

Figure 3-2: "Flex" grid style

Spectrum Analysis

You can select following measurement items with the **MEASURE** key when you select **S/A** and then the **Spectrum Analyzer** side key.

Table 3-2: Measurement items in the S/A mode

MEASURE menu	Title	Ref page
Channel Power	Channel Power Measurement	page 3-5
ACPR	ACPR (Adjacent Channel Power Ratio) Measurement	page 3-7
C/N	C/N (Carrier to Noise ratio) Measurement	page 3-9
OBW	OBW (Occupied Band Width) Measurement	page 3-11
Carrier Frequency	Carrier Frequency Measurement	page 3-13
EBW	EBW (Emission Band Width) Measurement	page 3-15
Spurious	Spurious Signal Measurement	page 3-17

Pressing the **Measurement Off** side key stops the measurement and returns to the original spectral display.

Channel Power Measurement

This measurement calculates power in the range specified using a band power marker (shown in Figure 3–3). An example of the channel power measurement is shown in Figure 3–4.

To make a channel power measurement, do the following steps:

1. Press the **S/A** key and then the **Spectrum Analyzer** side key.
2. Press the **Channel Power** side key.
3. Display the spectrum waveform of the measurement signal:
 - a. Press the **RUN/STOP** key on the front panel to start data acquisition.

NOTE. For details on setting frequency, span, and amplitude, refer to Setting Frequency and Span on page 3–79 and Setting Amplitude on page 3–87.

- b. Set the frequency by pressing the **FREQUENCY/CHANNEL** key on the front panel.
 - c. Set the span by pressing the **SPAN** key on the front panel.
 - d. Set the amplitude by pressing the **AMPLITUDE** key on the front panel.
4. Set the following Measurement Setup controls by pressing the **MEAS SETUP** key on the front panel.

Meas Setup Menu

The Meas Setup menu for the channel power measurement contains the following controls:

Integration Bandwidth. Sets frequency range for power measurement (see Figure 3–3).

Measurement Filter Shape... Selects a filter shape from the following four types: Rect (Rectangular), Gaussian, Nyquist, or Root Nyquist.

Rolloff Ratio. Enters rolloff ratio when Nyquist or Root Nyquist filter is selected. Range: 0.0001 to 1 (default value: 0.5).

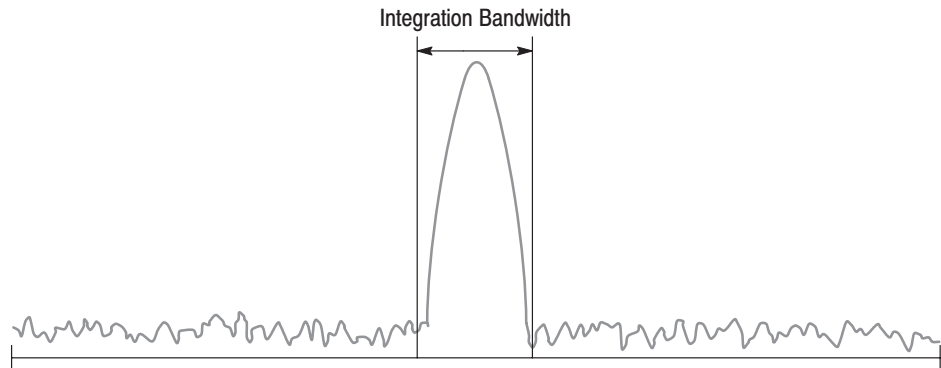

Figure 3-3: Channel power measurement band power markers

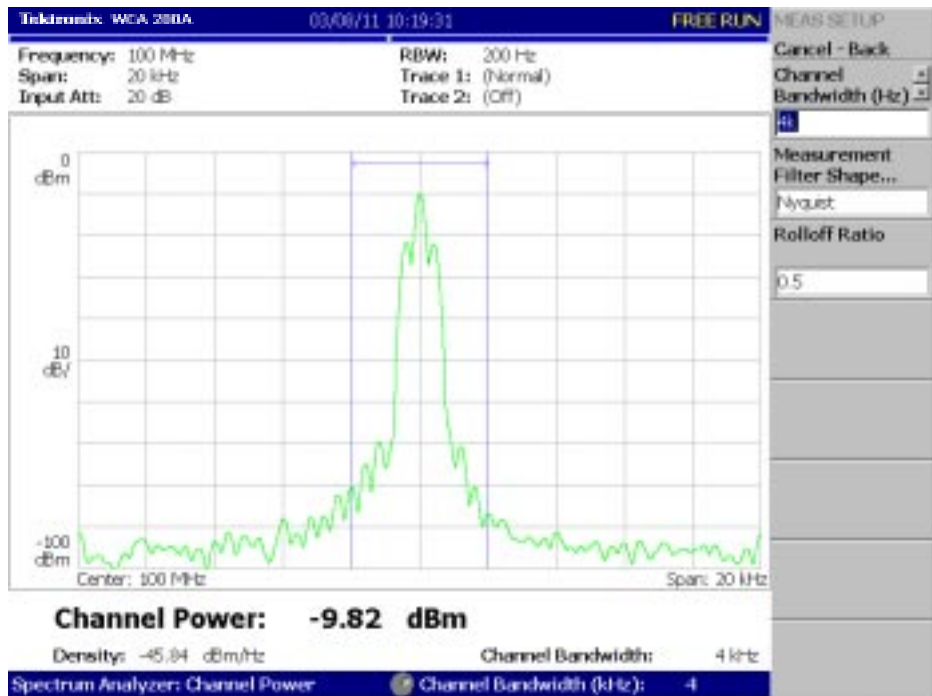

Figure 3-4: Channel power measurement

ACPR Measurement

The power ratio of carrier signal to signal appearing in its frequency band adjacent area (leak signal) is measured in the ACPR (Adjacent Channel Power Ratio) measurement. Frequency ranges are set using three band power markers. Figure 3–6 shows an example of the ACPR measurement.

Basic Procedure

Follow these steps to perform an ACPR measurement:

1. Press the **S/A** key and then the **Spectrum Analyzer** side key.
2. Press the **ACPR** side key.
3. Display the spectrum waveform of the measurement signal:
 - a. Press the **RUN/STOP** key on the front panel to start data acquisition.

NOTE. For details on setting frequency, span, and amplitude, refer to Setting Frequency and Span on page 3–79 and Setting Amplitude on page 3–87.

- b. Set the frequency by pressing the **FREQUENCY/CHANNEL** key on the front panel.
 - c. Set the span by pressing the **SPAN** key on the front panel.
 - d. Set the amplitude by pressing the **AMPLITUDE** key on the front panel.
4. Set the following Measurement Setup controls by pressing the **MEAS SETUP** key on the front panel.

Meas Setup Menu

The Meas Setup menu for the ACPR measurement contains the following controls (see Figure 3–5):

Main Channel Bandwidth. Sets frequency range of main channel.

Adjacent Channel Bandwidth. Sets frequency range of adjacent channel.

Chan Spacing. Sets a frequency interval between two adjacent channels.

Measurement Filter Shape... Selects a filter shape from the following four types: Rect (Rectangular), Gaussian, Nyquist, or Root Nyquist

Rolloff Ratio. Enters rolloff ratio when Nyquist or Root Nyquist filter is selected. Range: 0.0001 to 1 (default value: 0.5).

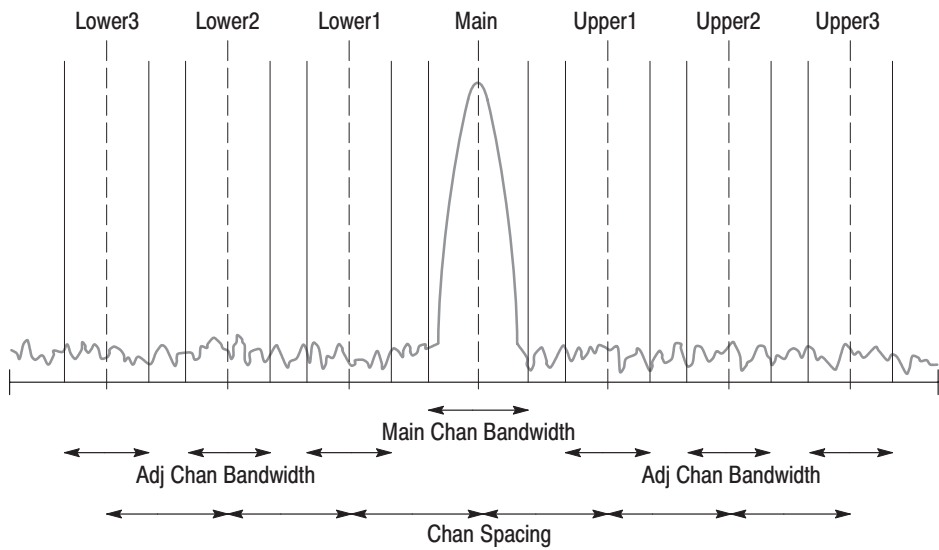

Figure 3-5: ACPR measurement band power markers

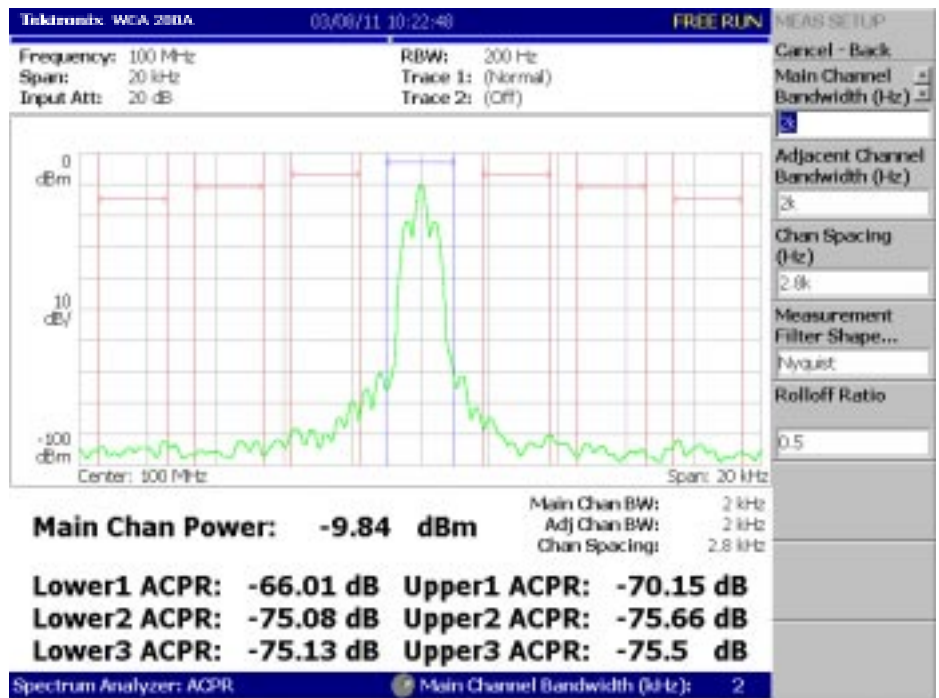

Figure 3-6: Example of ACPR measurement

C/N Measurement

Measures Carrier to Noise ratio (C/N).

Basic Procedure

To make a C/N measurement, do the following steps:

1. Press the **S/A** key and then the **Spectrum Analyzer** side key.
2. Press the **C/N** side key.
3. Display the spectrum waveform of the measurement signal:
 - a. Press the **RUN/STOP** key on the front panel to start data acquisition.
 - b. Set the frequency by pressing the **FREQUENCY/CHANNEL** key on the front panel.
 - c. Set the span by pressing the **SPAN** key on the front panel.
 - d. Set the amplitude by pressing the **AMPLITUDE** key on the front panel.

For details on setting frequency, span, and amplitude, refer to *Setting Frequency and Span* on page 3–79 and *Setting Amplitude* on page 3–87.

4. Set the following measurement setup controls by pressing the **MEAS SETUP** key on the front panel.

Meas Setup Menu

The Meas Setup menu for the C/N measurement contains the following controls (see Figure 3–7).

Offset Frequency. Sets the offset frequency from carrier to noise. The setting range is $-(\text{span})/2$ to $+(\text{span})/2$.

Noise Bandwidth. Sets the noise bandwidth.

Carrier Bandwidth. Sets the carrier bandwidth.

Measurement Filter Shape... Selects a filter shape from the following four types: Rect (Rectangular), Gaussian, Nyquist, or Root Nyquist

Rolloff Ratio. Enters rolloff ratio when Nyquist or Root Nyquist filter is selected. Range: 0.0001 to 1 (default value: 0.5).

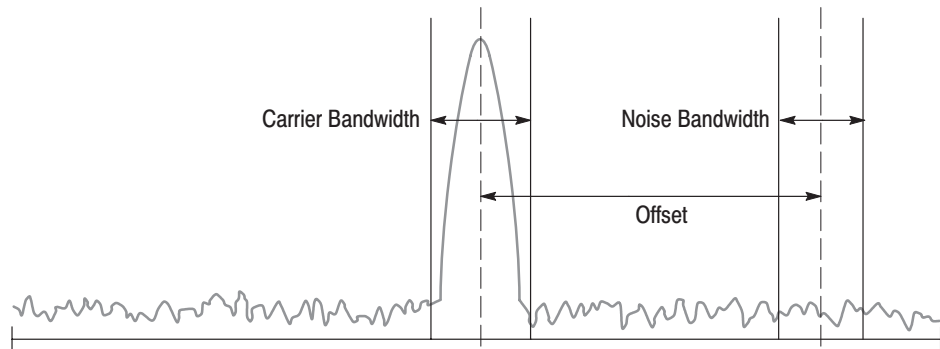

Figure 3-7: C/N measurement band power markers

Figure 3-8 shows an example of the C/N measurement.

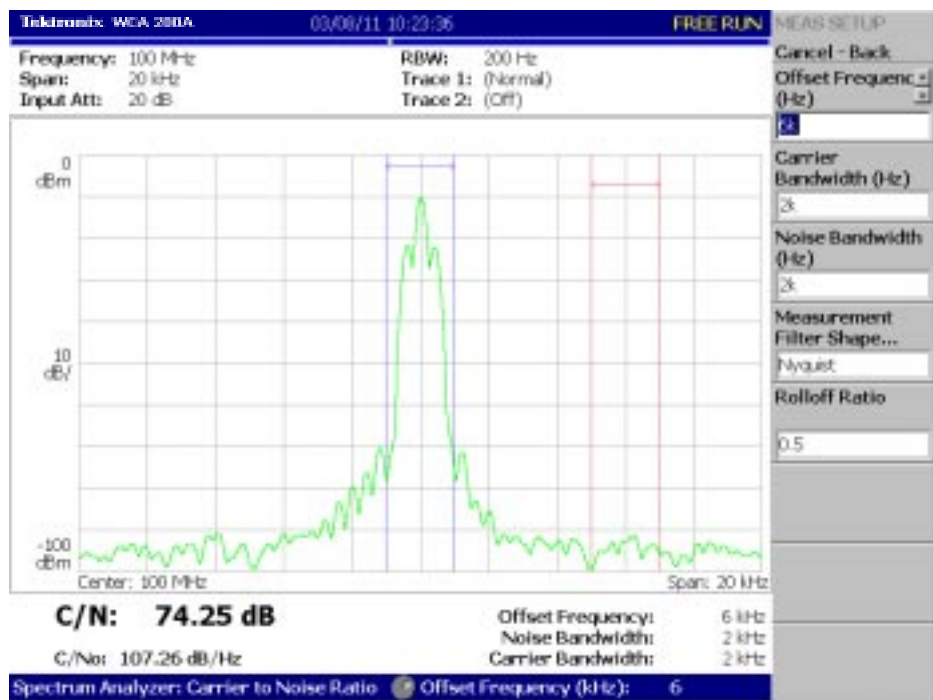

Figure 3-8: Example of C/N measurement

OBW Measurement

The OBW (Occupied Bandwidth) measures the frequency bandwidth, using the ratio you specify for carrier signal power / power within the span setting.

Basic Procedure

To make an OBW measurement, do the following steps:

1. Press the **S/A** key and then the **Spectrum Analyzer** side key.
2. Press the **OBW** side key.
3. Display the spectrum waveform of the measurement signal:
 - a. Press the **RUN/STOP** key on the front panel to start data acquisition.

NOTE. For details on setting frequency, span, and amplitude, refer to Setting Frequency and Span on page 3–79 and Setting Amplitude on page 3–87.

- b. Set the frequency by pressing the **FREQUENCY/CHANNEL** key on the front panel.
 - c. Set the span by pressing the **SPAN** key on the front panel.
 - d. Set the amplitude by pressing the **AMPLITUDE** key on the front panel.
4. Set the following measurement setup control by pressing the **MEAS SETUP** key on the front panel.

Meas Setup Menu

The Meas Setup menu for the OBW measurement contains the following control.

Power Ratio. Specifies the power ratio of the carrier and span regions for calculating OBW (see Figure 3–9). The default setting is 99% as defined in T–53 or IS–95 standard. Range: 80 to 99.8%.

Figure 3–10 shows an example of OBW measurement.

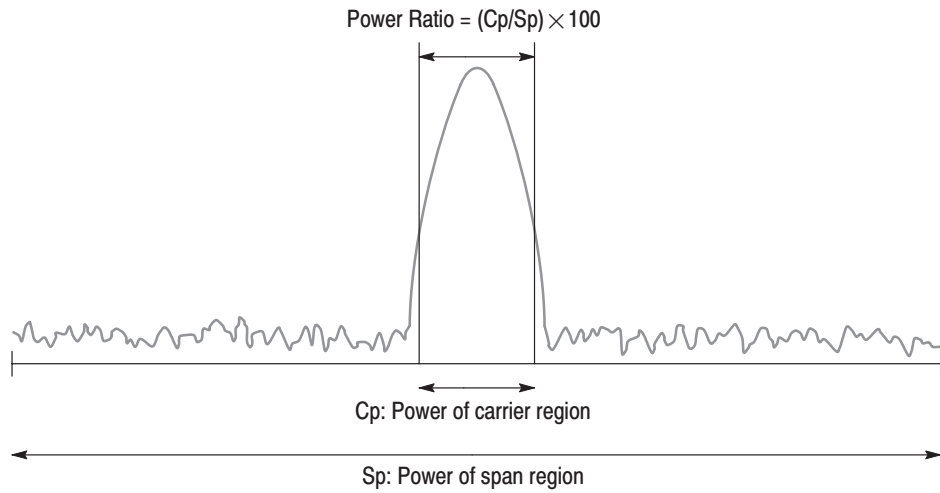

Figure 3-9: OBW measurement band power marker

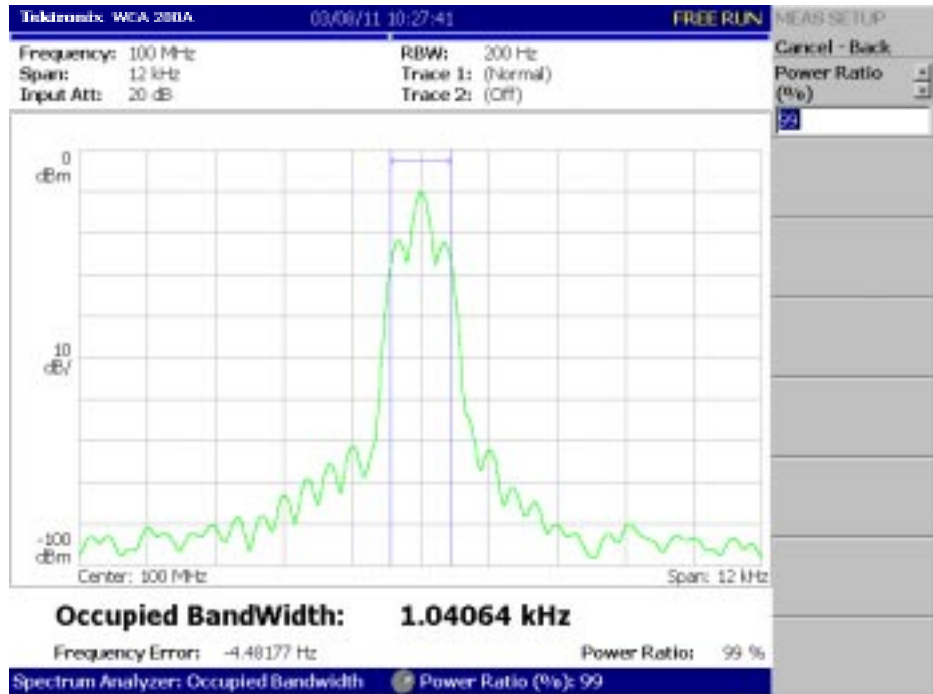

Figure 3-10: Example of OBW measurement

Carrier Frequency Measurement

Carrier frequency is accurately measured using the counter function.

Figure 3–11 shows an example of carrier frequency measurement.

Basic Procedure

To make a carrier frequency measurement, do the following steps:

1. Press the **S/A** key and then the **Spectrum Analyzer** side key.
2. Press the **Carrier Frequency** side key.
3. Display the spectrum waveform of the measurement signal:
(It is **not** necessary to place the signal peak at center screen.)

NOTE. You must set the frequency and the span to display only the spectrum with the carrier you want to measure. Measurement error will occur if other frequency components are displayed together.

- a. Press the **RUN/STOP** key on the front panel to start data acquisition.

NOTE. For details on setting frequency, span, and amplitude, refer to Setting Frequency and Span on page 3–79 and Setting Amplitude on page 3–87.

- b. Set the frequency by pressing the **FREQUENCY/CHANNEL** key on the front panel.
 - c. Set the span by pressing the **SPAN** key on the front panel.
 - d. Set the amplitude by pressing the **AMPLITUDE** key on the front panel.
4. Set the following measurement setup control by pressing the **MEAS SETUP** key on the front panel.

Meas Setup Menu

The Meas Setup menu for the Carrier Frequency measurement contains the following control:

Counter Resolution. Sets the counter resolution. The measurement result is displayed on the bottom of the view with this resolution.

Range: 1 mHz to 1 MHz in a tenfold sequence (default: 1 Hz).

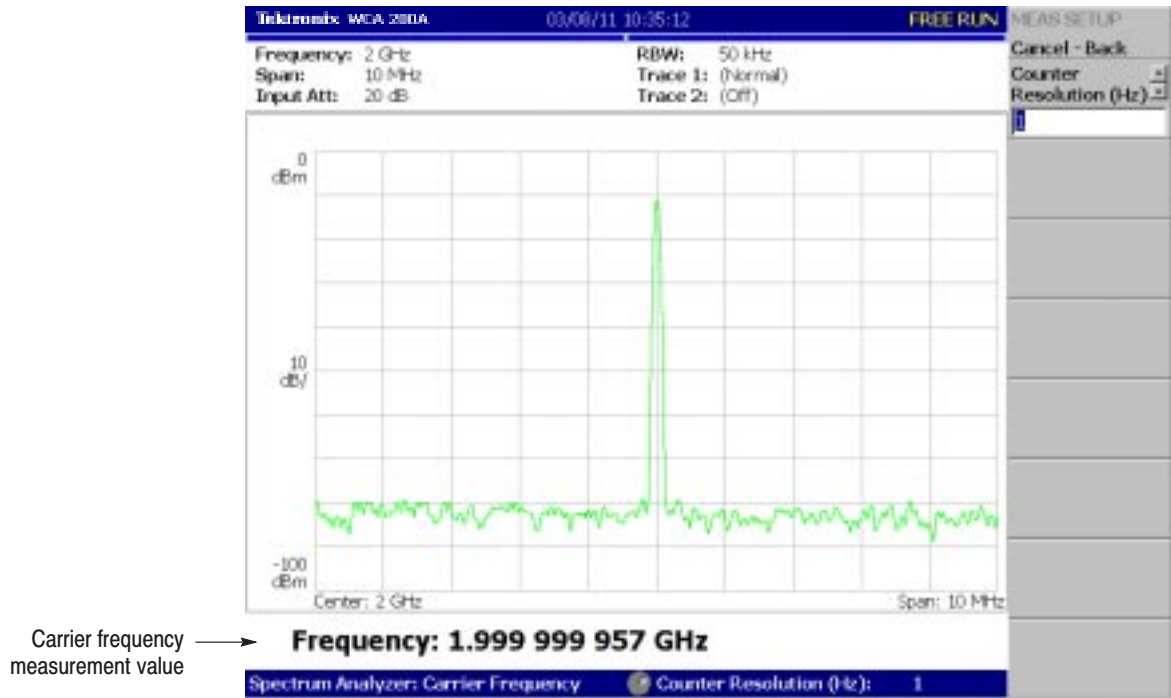

Figure 3-11: Carrier frequency measurement

EBW Measurement

The frequency bandwidth between the maximum peak of spectrum and the specified dB value is measured in EBW (Emission Bandwidth).

Basic Procedure

To make an EBW measurement, do the following steps:

1. Press the **S/A** key and then the **Spectrum Analyzer** side key.
2. Press the **EBW** side key.
3. Display the spectrum waveform of the measurement signal:
 - a. Press the **RUN/STOP** key on the front panel to start data acquisition.

NOTE. For details on setting frequency, span, and amplitude, refer to Setting Frequency and Span on page 3–79 and Setting Amplitude on page 3–87.

- b. Set the frequency by pressing the **FREQUENCY/CHANNEL** key on the front panel.
 - c. Set the span by pressing the **SPAN** key on the front panel.
 - d. Set the amplitude by pressing the **AMPLITUDE** key on the front panel.
4. Set the following measurement setup control by pressing the **MEAS SETUP** key on the front panel.

Meas Setup Menu

The Meas Setup menu for the EBW measurement contains the following item:

Measurement Level. Specifies how far down from the peak level the bandwidth is measured (see Figure 3–12).

Range: –100 to –1 dB (default: –30 dB).

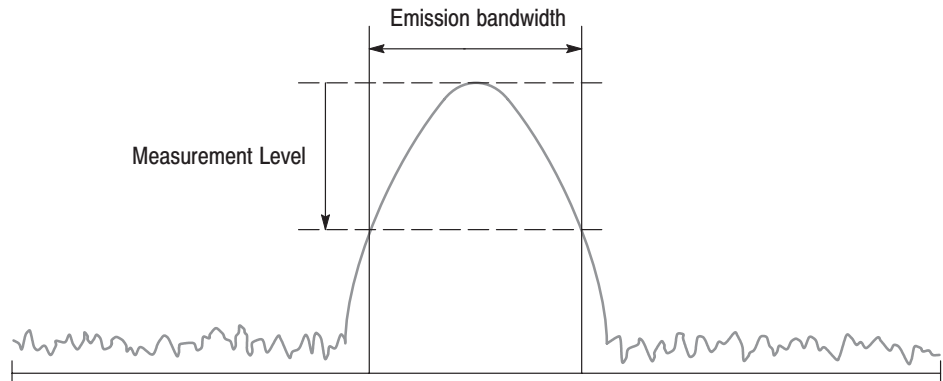

Figure 3-12: EBW measurement band power markers

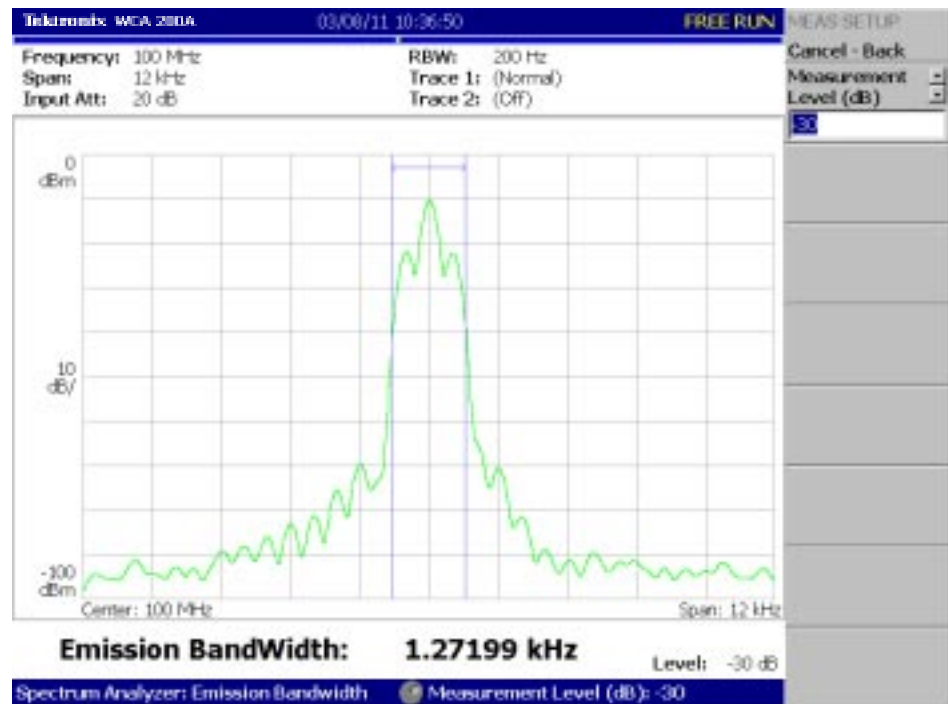

Figure 3-13: EBW measurement

Spurious Signal Measurement

The spurious signal measurement detects up to 20 spurious signals and calculates the frequency difference and the amplitude ratio relative to the normal signal by setting the level conditions.

Figure 3–15 shows an example of spurious signal measurement.

Basic Procedure

To make a spurious signal measurement, do the following steps:

1. Press the **S/A** key and then the **Spectrum Analyzer** side key.
2. Press the **Spurious** side key.
3. Display the spectrum waveform of the measurement signal:
 - a. Press the **RUN/STOP** key on the front panel to start data acquisition.

NOTE. For details on setting frequency, span, and amplitude, refer to Setting Frequency and Span on page 3–79 and Setting Amplitude on page 3–87.

- b. Set the frequency by pressing the **FREQUENCY/CHANNEL** key on the front panel.
- c. Set the span by pressing the **SPAN** key on the front panel.
- d. Set the amplitude by pressing the **AMPLITUDE** key on the front panel.

NOTE. For detecting stationary spurious signals, waveform averaging is effective for reducing noise. Refer to page 3–131 for averaging.

4. Set the following measurement setup controls by pressing the **MEAS SETUP** key on the front panel.

Meas Setup Menu

The Meas Setup menu for the spurious signal measurement contains the following controls:

Signal Threshold. Sets the threshold for detecting the standard signal (see Figure 3–14). A signal whose amplitude is larger than this threshold is regarded as a standard signal. Range: –100 to +30 dBm.

Ignore Region. Sets the frequency range with the carrier (standard signal) peak as the center in which spurious signals are not to be detected, for avoiding false recognition of spurious signals (see Figure 3–14). Range: 0 to span/2 Hz (default: 0 Hz)

Spurious Threshold. Sets the threshold for detecting spurious signals (see Figure 3–14). Enter the value relative to the peak of standard signal. Range: –90 to –30 dB.

Excursion. Sets the deviation amount of amplitude that is considered to be spurious (see Figure 3–14). A signal with amplitude higher than the set value of the Spurious Threshold and larger than the set value of Excursion is considered to be spurious. Range: 0 to 30 dB (default: 3 dB)

Scroll Table. Horizontally scrolls the spurious table displayed in the lower part of the screen. Up to 20 spurious signals are displayed.

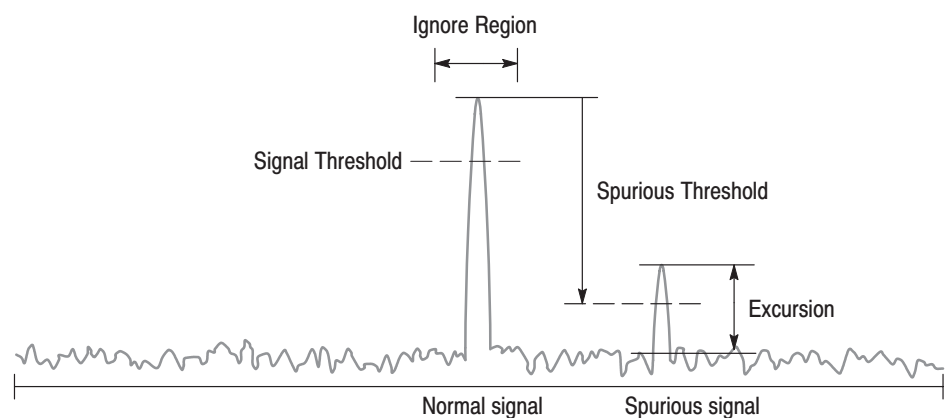

Figure 3-14: Setting up spurious signal measurement

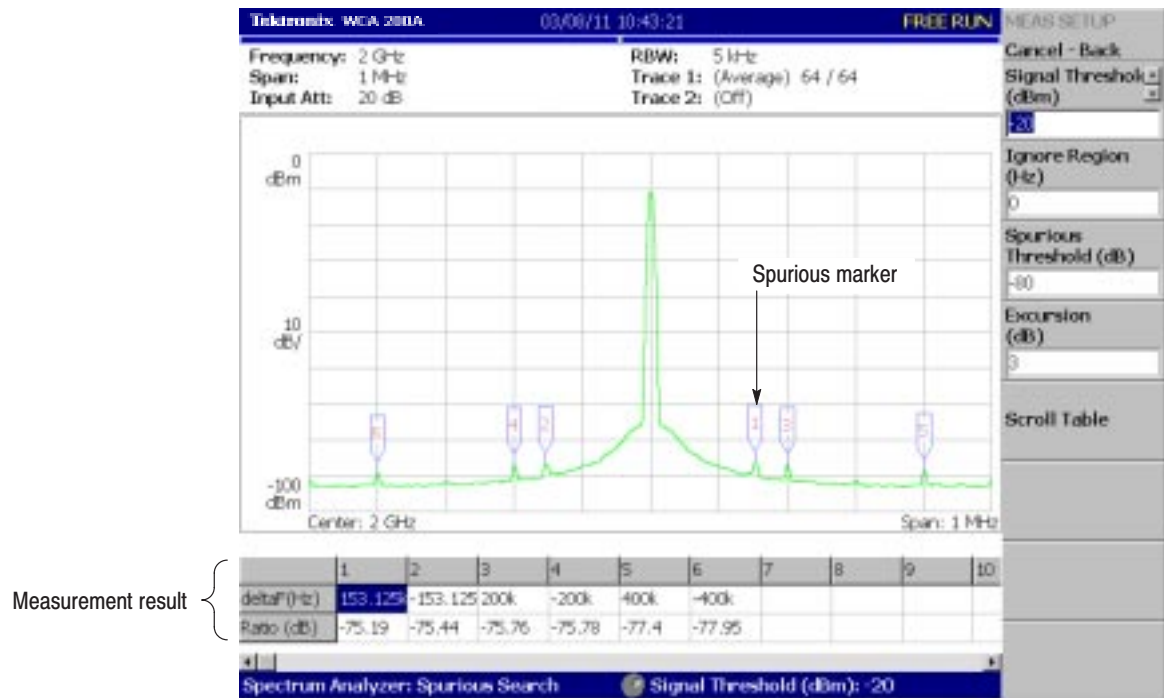

Figure 3-15: Example of spurious signal measurement

Detected spurious signals are assigned markers, numbered in descending order by amplitude. The frequency difference (deltaF) and the amplitude ratio (Ratio) in relation to the standard signal are shown in the table in the lower part of the screen.

Spectrogram Display

You can display the spectrum of an input signal concurrently with the spectrogram.

Follow these steps to display the spectrogram:

1. Press the **S/A** key on the front panel.
2. Press the **S/A with Spectrogram** side key.

The spectrum and spectrogram are displayed on the same screen as shown in Figure 3–16.

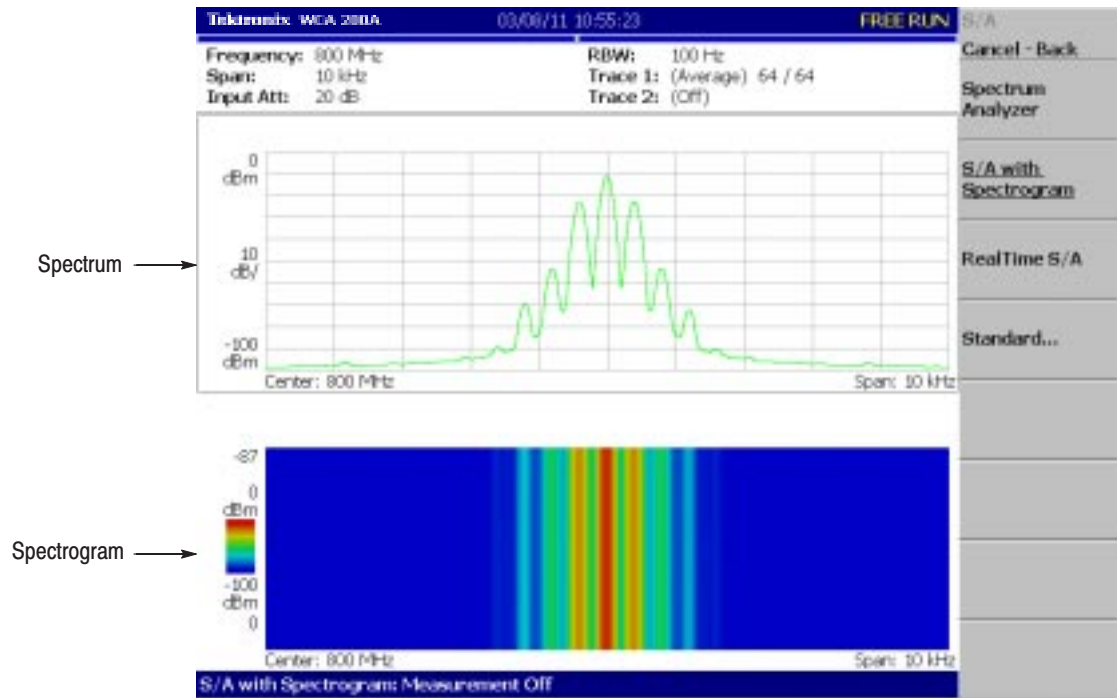
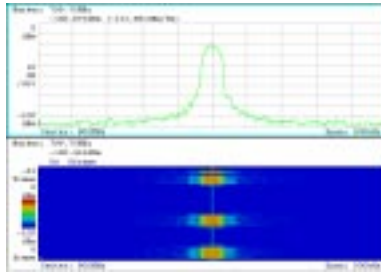

Figure 3–16: Spectrum and spectrogram concurrent display

Changing Display Style

You can change display style as required.

1. Press the **VIEW: DEFINE** key.
2. Press the **View Orientation** side key to select the view style: **Wide** or **Tall**.



Wide display
Displays spectrum and spectrogram/waterfall in line-split display.

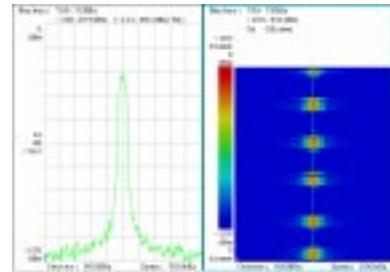

Tall display
Display spectrum and spectrogram/waterfall side by side.

Figure 3–17: View orientation

3. When you display either spectrum or spectrogram only on full-screen, press the **VIEW: SELECT** key to select the view. The selected view is surrounded by a light-blue frame.
4. Press the **Show Views** side key and select **Single** as shown in Figure 3–18.

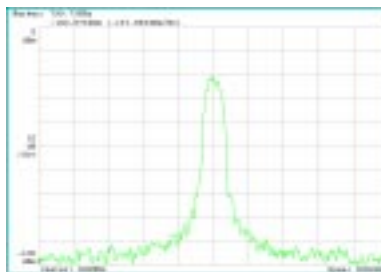

Single display
Displays the selected view on one screen.

Figure 3–18: Single display

Refer to *Scale and Format of Views* on page 3–63 for details.

Real-Time Analysis

When you select **S/A** → **Real Time S/A**, the analyzer performs real-time analysis, displaying the spectrogram.

NOTE. In real-time mode, the **FFT/RBW** and the **TRACE/AVG** menus are not available. The settings of **FFT points** and **window** are fixed to **1024** and **Blackman-Harris 4B**, respectively.

The screen layout is the same as that when you select **S/A** → **S/A with Spectrogram**. Refer to *Spectrogram Display* on page 3–20.

Features of the Real-Time Mode

Defining one frame as data in the number of FFT points and one block as a specified number of frames, an input waveform is acquired on block base. The number of frames acquired at one time is called block size. In the normal spectrum analysis, the instrument acquires data for the block size determined from RBW and creates one spectrum waveform. In the real-time mode, the instrument acquires data for the block size specified with the Timing menu, performs the FFT process, and creates spectrum waveforms for each frame so you can observe spectrum variation in time seamlessly. The difference between normal and real-time modes is shown in Figure 3–19

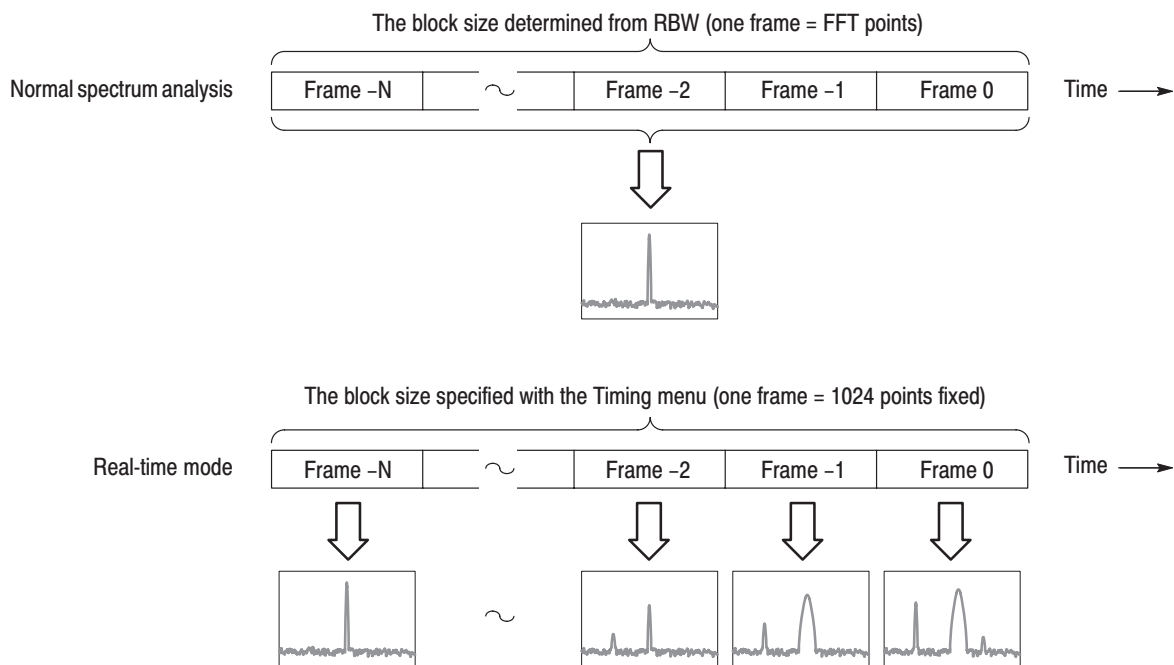

Figure 3–19: Difference between normal and real-time modes

Table 3–3 shows the features of the real-time mode compared with the normal spectrum analysis.

Table 3–3: Features of the real-time mode

Item	Normal spectrum analysis	Real-time mode
Span	Up to 3 GHz (arbitrary value can be set)	Up to 15 MHz (1-2-5 sequence)
Trigger	Only the Repeat menu item available	All the Trigger menu items available
RBW/FFT	FFT points: 64 to 8192 (powers of 2) RBW: 1 Hz to 10 MHz	FFT points: 1024 fixed RBW: No RBW process
Timing	No timing parameters	Acquisition Length and Spectrum Offset can be set

Basic Procedure

The following steps show the basic procedure for the real-time spectrum analysis with spectrogram:

1. Press the **S/A** key on the front panel.
2. Press the **Real Time S/A** side key. The spectrum is displayed concurrently with the spectrogram.
3. Display the spectrum waveform of the measurement signal:

NOTE. For details on setting frequency, span, and amplitude, refer to Setting Frequency and Span on page 3–79 and Setting Amplitude on page 3–87.

For details on setting trigger, refer to Trigger on page 3–115.

- a. Set the frequency by pressing the **FREQUENCY/CHANNEL** key on the front panel.
- b. Set the span by pressing the **SPAN** key on the front panel.
Table 3–4 shows the span setting range.
- c. Set the amplitude by pressing the **AMPLITUDE** key on the front panel.
- d. Set the trigger by pressing the **TRIG** key on the front panel.

Table 3–4: Span setting range

Measurement band ¹	Setting range
RF	100 Hz to 10 MHz (1-2-5 sequence) and 15 MHz
Baseband	100 Hz to 20 MHz (1-2-5 sequence)

¹ Baseband: DC to 20 MHz; RF: 15 MHz to 3 GHz (WCA230A) / 8 GHz (WCA280A)

4. Press the **TIMING** key on the front panel and then the **Acquisition Length** side key to set the time length to acquire one block.

Suppose that one block contains N frames; the acquisition length is calculated with this equation:

$$(\text{One block acquisition length}) = N \times (\text{One frame acquisition length})$$

Where N = 1 to 16000 (standard) or 64000 (Option 02)

One frame acquisition length is determined by span internally, and shown with Frame Length in the setup display area (see Figure 3–20). For the details, refer to Table A–10 on page A–8 in *Appendix A: Specifications*.

Waveform data is acquired and displayed on block base. For details about the time parameters, refer to page 3–112.

5. When you have acquired the measurement data, stop the data acquisition. If the analyzer is in the continuous acquisition mode, press **RUN/STOP**.
6. Press the **Spectrum Offset** side key and set the number of the frame to measure and display in the spectrum view (upper view) by turning the general purpose knob or using the numeric keypad.

Serial numbers are given to each frame regardless of the block size, with zero representing the latest frame. The selected frame is indicated by the marker on the spectrogram (see Figure 3–20).

Alternatively, the frame number can be set using the Marker Setup menu with the following steps a to d:

- a. Press the VIEW: **SELECT** key to select the spectrogram view.
- b. Press the **MARKER SETUP** key.
- c. Press the side key **Go to page 2 → Marker X Vertical**.
- d. Set the frame number by turning the general purpose knob or using the numeric keypad.

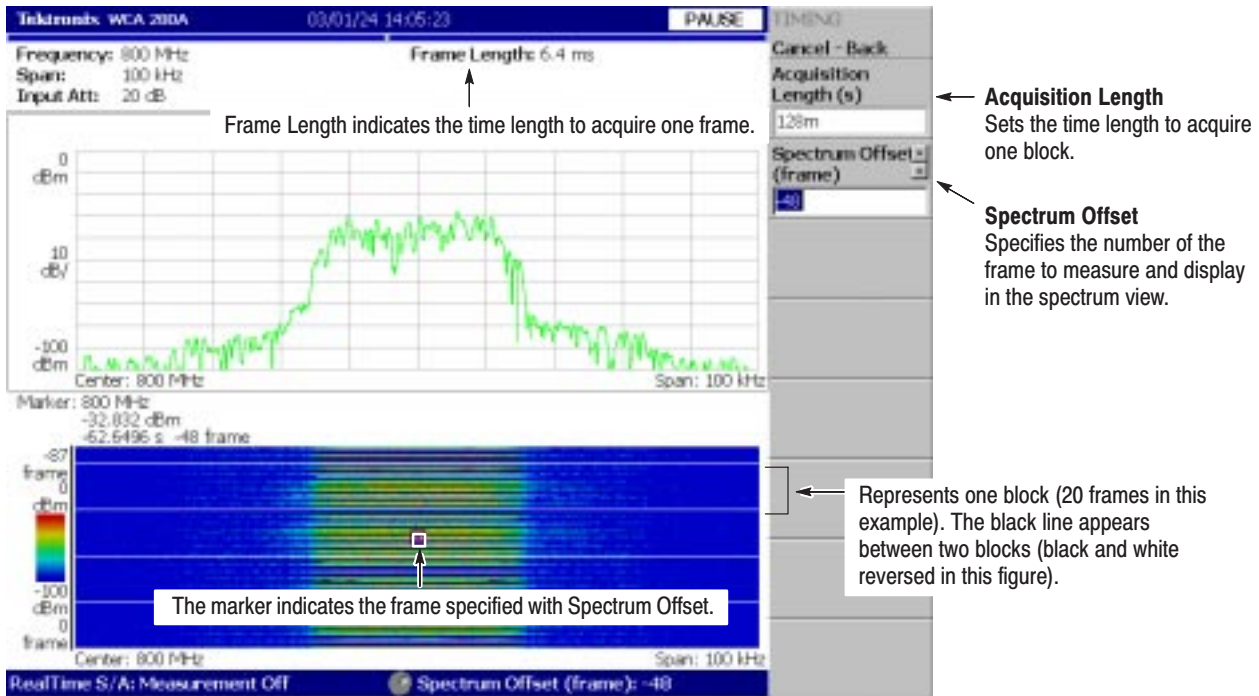

Figure 3-20: Real-time mode

7. When you perform spectrum measurement, press the **MEASURE** key on the front panel. The measurement items and procedures are the same as in the normal spectrum analysis. Refer to *Spectrum Analysis* on page 3-4.
8. When you want to change the display format, press the **DEFINE** key on the front panel. The setting procedure is the same as in the normal spectrum analysis. Refer to *Spectrogram Display* on page 3-20.

NOTE. In the real-time mode, you cannot turn on or off the spectrogram in the View: Define menu.

Modulation Analysis (Demod Mode)

This section describes measurement methods for the modulation analysis (Demod mode).

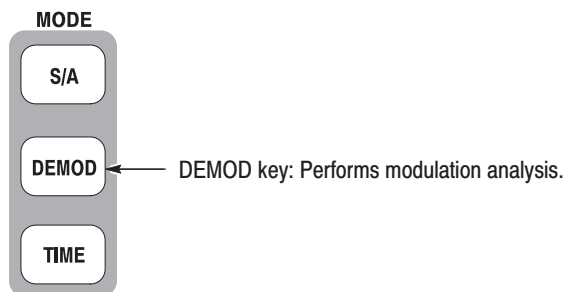

There are three items in the Demod menu:

- **Analog Demod:** Performs analog modulation analysis. Refer to page 3–35 for details.
- **Digital Demod:** *Option 21 Only.* Performs digital modulation analysis. Refer to page 3–42 for details.
- **Standard...:** Performs modulation analysis according to a communication standard. For details, refer to the user manual included in each option:

Table 3-5: Standard menu in the Demod mode

Menu item	Option	Description
W-CDMA-DL	Option 22	W-CDMA downlink analysis
W-CDMA-UL	Option 23	W-CDMA uplink analysis
GSM/EDGE	Option 24	GSM/EDGE analysis
cdma2000-Fwd	Option 25	cdma2000 forward link analysis
cdma2000-Rev	Option 25	cdma2000 reverse link analysis
1xEV-DO-Fwd	Option 26	cdma2000 1xEV-DO forward link analysis
1xEV-DO-Rev	Option 26	cdma2000 1xEV-DO reverse link analysis

Layout of the Measurement Screen

The following three views are displayed on screen by default in the Demod mode (see Figure 3–21):

- **Overview:** Displays all data in one block. The Timing field on the bottom of the overview shows “T” indicating a trigger point, the green horizontal line indicating a waveform analysis range in the main view, and the pink horizontal line indicating the FFT processing range for the spectrum in the subview.

For details about the trigger point, refer to *Trigger Point Indicator* on page 3–130.

- **Main view:** Displays the measurement results and waveform for the range specified in the overview. The measurement results and waveform can be displayed separately.
- **Subview:** Spectrum is displayed by default as an auxiliary view. The FFT processing range can be specified in the overview.

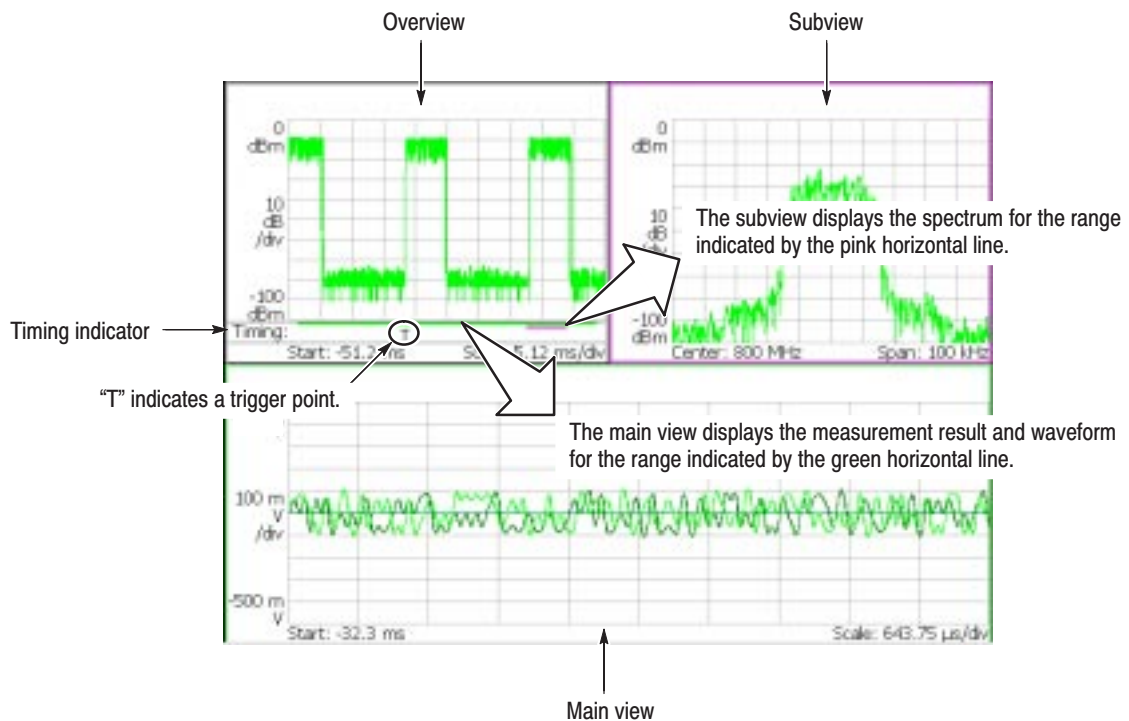

Figure 3–21: Demod mode screen

Setting Analysis Range for the Main View

The analysis is performed for the range specified in the overview (see Figure 3–22), and then the measurement result and waveform are displayed in the main view. Set the analysis range after data acquisition with the following procedure, using the TIMING menu. The range is indicated by green lines.

1. Press the **TIMING** key on the front panel.
2. Set the time length to acquire one block by pressing the **Acquisition Length** side key.

Suppose that one block contains N frames; the acquisition length is calculated with this equation:

$$(\text{One block acquisition length}) = N \times (\text{One frame acquisition length})$$

One frame acquisition length is determined by span and indicated on the **Spectrum Length** side key.

3. *For data acquired in the continuous mode:* Specify the number of the block to be analyzed by pressing the **Acquisition History** side key. 0 is the latest block.
4. Specify the time length of analysis range by pressing the **Analysis Length** side key.
5. Specify the start point of the analysis range by pressing the **Analysis Offset** side key.

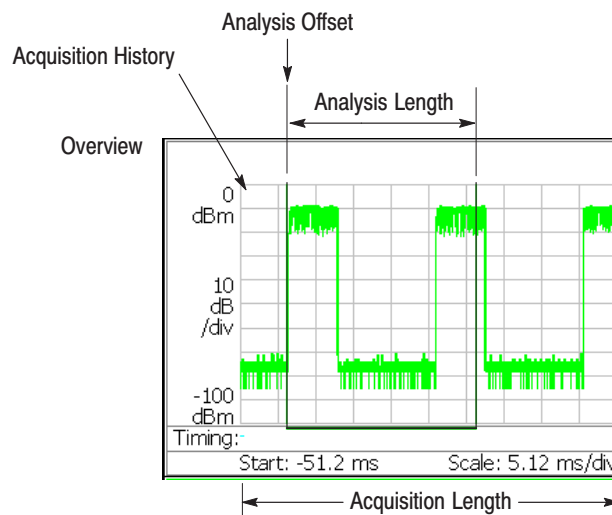

Figure 3–22: Analysis range setting in the overview

Specifying Origin of Analysis Range with Marker. You can also use the marker (□) in place of the **Analysis Offset** side key to specify the origin of analysis range. Do the following steps in place of step 5 on the previous page.

1. Press the **MARKERS: SETUP** key on the front panel (see Figure 3–23).
2. Press the **Markers** side key to select **Single**.
The marker (□) appears on the screen.
3. Rotate the general purpose knob to move the marker to the measurement start point.
4. Press the **MARKER →** key on the front panel and then press the **Analysis Time = Marker Time** side key. The green line fits to the specified range.

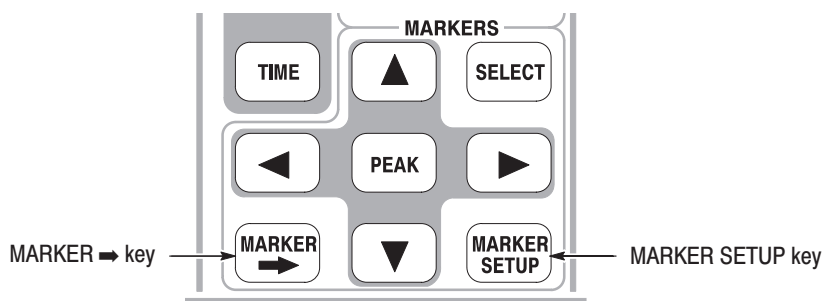

Figure 3–23: MARKERS keys

Specifying Analysis Range with Marker and Reference Cursor. You can use the marker and the reference cursor in place of the **Analysis Length** and the **Analysis Offset** side keys to specify the analysis range. Perform the following steps in place of steps 4 and 5 on the previous page.

1. Press the **VIEW: SELECT** key on the front panel to select the overview.
2. Press the **MARKERS: SETUP** key on the front panel.
3. Press the **Markers** side key to select **Single**.
The marker (□) appears on the screen.
4. Rotate the general purpose knob to move the marker to the measurement start point.
5. Press the **Reference Cursor to Marker X** side key.
The reference cursor appears at the marker position (see Figure 3–24).
6. Rotate the general purpose knob to move the marker to the measurement stop point.

7. Press the **MARKER** \Rightarrow key on the front panel and then press the **Analysis Time = Marker Time** side key. The green line fits to the specified range.

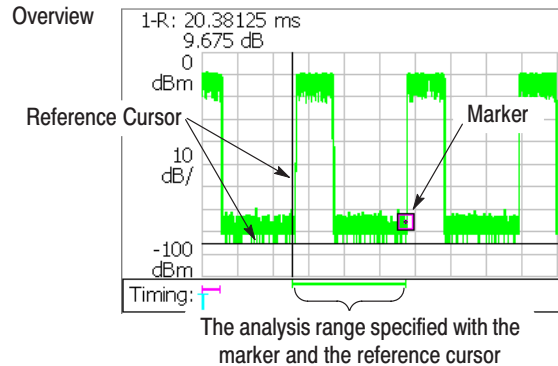

Figure 3-24: Specifying the range with the marker and the reference cursor

Setting FFT Processing Range for the Subview

Set the FFT processing range (shown in Figure 3-25) for the spectrum displayed in the subview with the following procedure using the Timing menu after data acquisition. The range is indicated by pink lines.

1. Press the **TIMING** key on the front panel.

The **Spectrum Length** side key shows the time for creating the FFT available in the subview. It is determined by the span internally.

2. Press the **Spectrum Offset** side key and specify the beginning of the range using the general purpose knob or numeric input keypad.

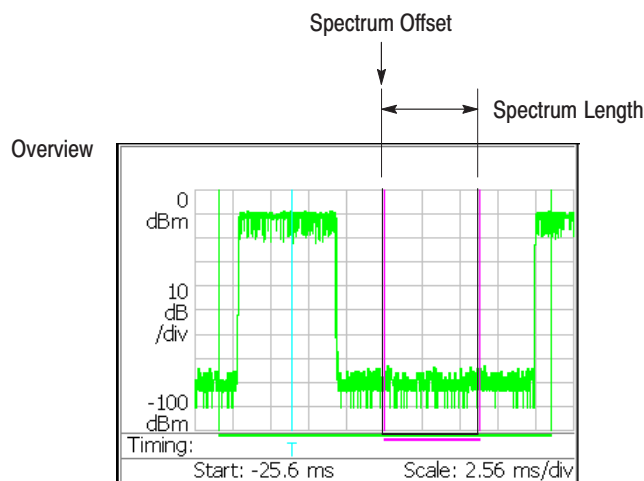

Figure 3-25: FFT processing range setting on the overview

Changing the Overview and Subview

By default, the overview shows the waveform representing the signal level change over time, and the subview shows the spectrum waveform. See the display in Figure 3–26.

NOTE. *You can change the subview only in the digital modulation analysis (Digital Demod mode in Option 21).*

To change the views, use the following procedure:

1. Press the VIEW: **DEFINE** key on the front panel.
2. Press the **Overview Content...** side key and select the overview:
 - Waveform (Amplitude vs. Time)
 - Spectrogram
3. *Digital modulation analysis (Digital Demod mode in Option 21) only*
Press the **Subview Content...** side key and select one of these views:
 - Spectrum
 - Constellation
 - EVM (Error Vector Magnitude)
 - IQ/Frequency (I/Q level or Frequency vs. Time)
 - Symbol Table
 - Eye Diagram

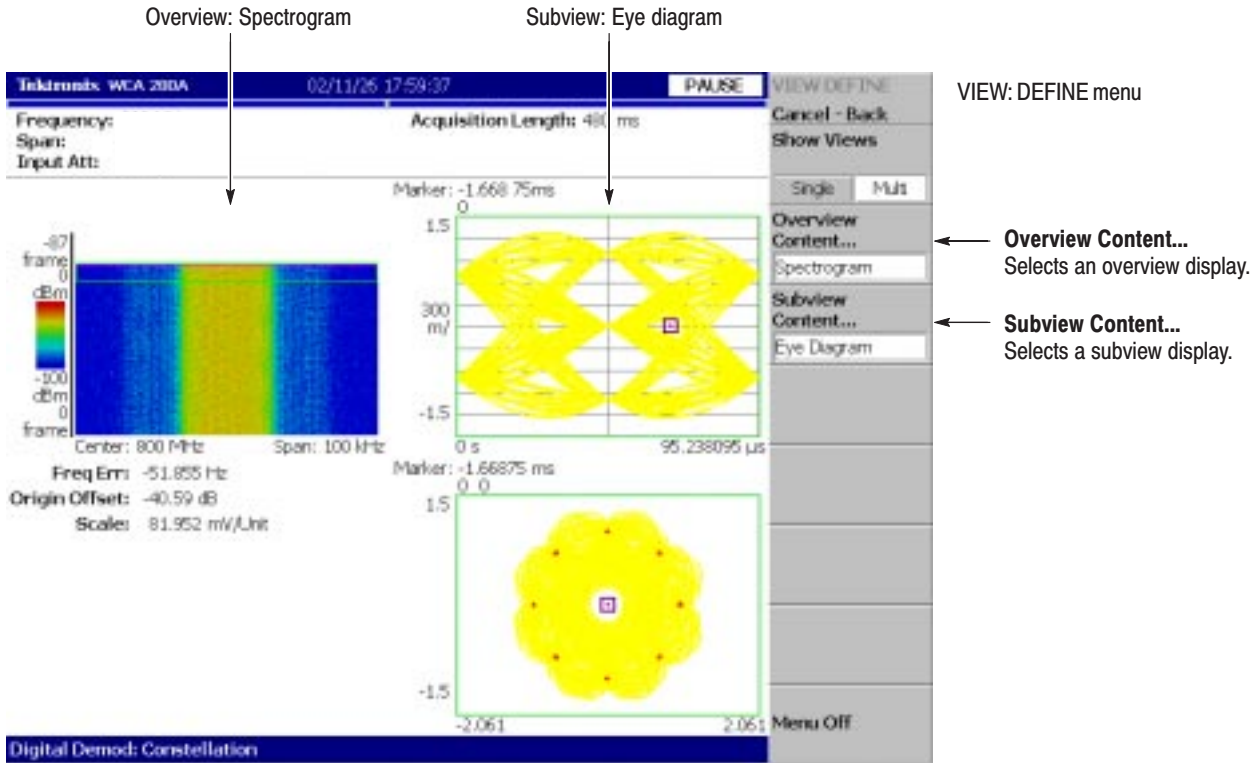
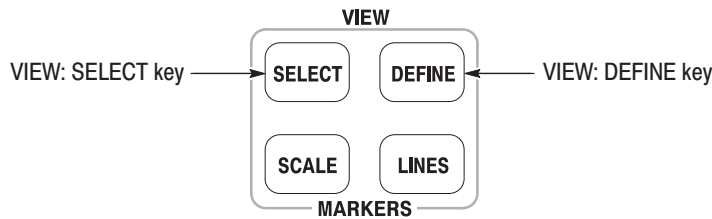

Figure 3-26: Changing the overview and subview

One-View Display

Three views are displayed on screen by default. To display one view, perform the following steps:

1. Press the VIEW: **DEFINE** key on the front panel.



2. Select a view to make the single display by pressing the **SELECT** key in the VIEW area. The selected view is surrounded by a white box. Figure 3–27 shows the one view display.
3. Press the **Show Views** side key to select **Single**.

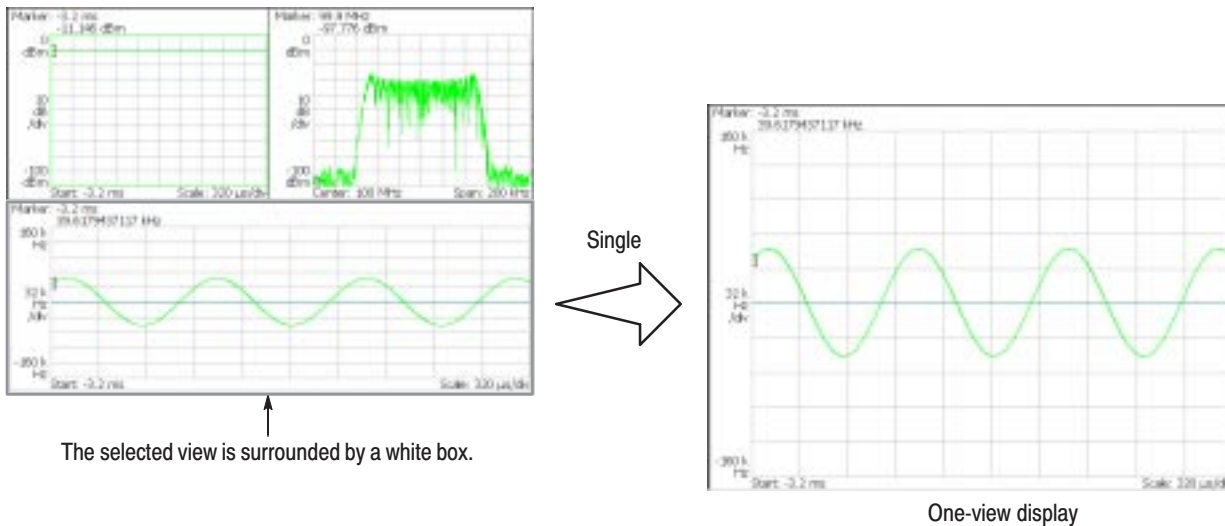

Figure 3–27: One-view display

Analog Modulation Analysis

You can select following measurement items shown in Table 3–6 with the **MEASURE** key when you select **Analog Demod** in the Demod menu.

Table 3–6: Analog modulation analysis

MEASURE menu	Description
AM Demod	AM signal measurement
FM Demod	FM signal measurement
PM Demod	PM signal measurement
IQ versus Time	I/Q level measurement

Basic Procedure

Follow this procedure to perform analog modulation analysis:

1. Press the MODE: **DEMODO** key on the front panel.
2. Press the **Analog Demod** side key.
3. Select the measurement item:
AM Demod, FM Demod, PM Demod, or IQ versus Time.
4. Display the measurement waveform:

NOTE. You should set appropriate frequency and span. It is important to set frequency and span as close to the measurement signal band as possible and finely adjust them. The modulated signal will not be recognized unless frequency and span are set appropriately.

For information about setting frequency, span, and amplitude, refer to Setting Frequency and Span on page 3–79 and Setting Amplitude on page 3–87.

- a. Set frequency by pressing the **FREQUENCY/CHANNEL** key on the front panel.
 - b. Set span by pressing the **SPAN** key on the front panel.
 - c. Set amplitude by pressing the **AMPLITUDE** key on the front panel.
5. Set analysis range by pressing the **TIMING** key on the front panel. Refer to page 3–29 for information about setting the analysis range.
 6. Set the measurement parameters by pressing the **MEAS SETUP** key on the front panel. For the Meas Setup menu, refer to the following sections.

ASK/FSK Modulation Analysis. Basic ASK and FSK modulation analysis can be performed using Analog Modulation Analysis. This analysis includes frequency deviation and depth of modulation. Typical settings are as follows:

■ ASK signal measurement

Measurement item . . . AM Demod
Span 500 kHz
Acquisition Length . . . 10.24 ms

■ FSK signal measurement

Measurement item . . . FM Demod
Span 500 kHz
Acquisition Length . . . 10.24 ms
Vertical Scale 1.6 MHz (deviation scale: 800 kHz)

The following pages show examples for each measurement item.
Refer to page 3–63 for information about setting scale and formatting each view.
Refer to page 3–32 for information about changing the overview and subview.

AM Signal Measurement

Measures AM signal. Figure 3–28 shows an example.

- Overview: Power vs. Time
- Subview: Spectrum
- Main view: Modulation factor vs. Time

MEASURE → **Show Measurements** is selected in Figure 3–28.

The AM signal measurement has no Meas Setup menu items.

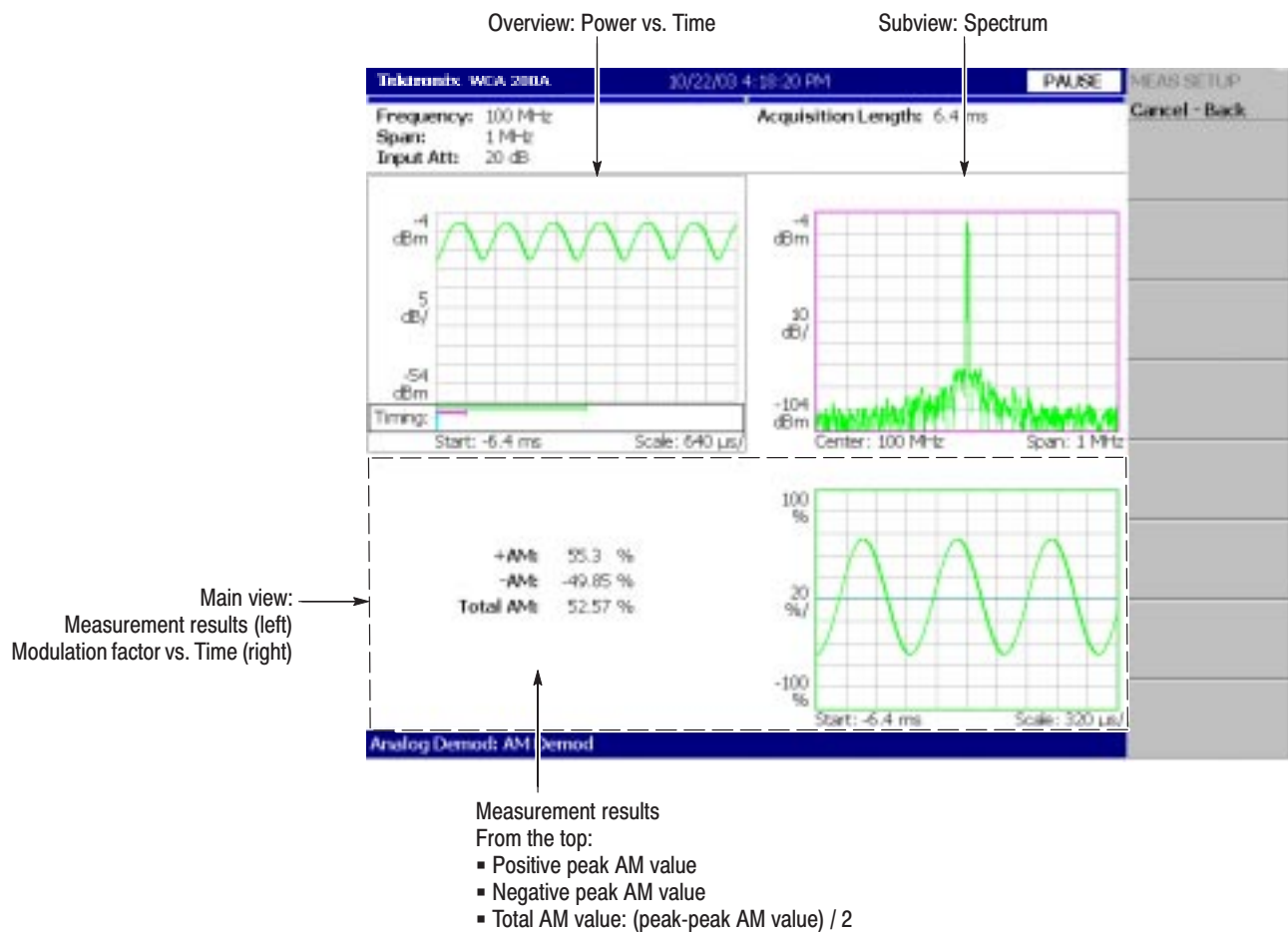

Figure 3–28: AM signal measurement

FM Signal Measurement Measures FM signal. Figure 3–29 shows an example.

- Overview: Power vs. Time
- Subview: Spectrum
- Main view: Frequency deviation vs. Time

MEASURE → **Show Measurements** is selected in Figure 3–29.

Meas Setup Menu The Meas Setup menu items for the FM signal measurement are as follows:

Auto Carrier. Determines whether to detect the carrier automatically.

- **On. Default.** Automatically detects the carrier for every frame. The error from the center frequency is shown on the **Freq Error** side key.
- **Off.** Sets the carrier frequency using **Frequency Offset** described below.

Frequency Offset. Sets the carrier frequency when Off is selected in Auto Carrier. Input the carrier offset from the center frequency.

Range: –30 to +30 MHz.

Threshold. Sets the threshold level above which the input signal is determined to be a burst in time domain. The burst detected first is used for the measurement.

Range: –100.0 to 0.0 dB.

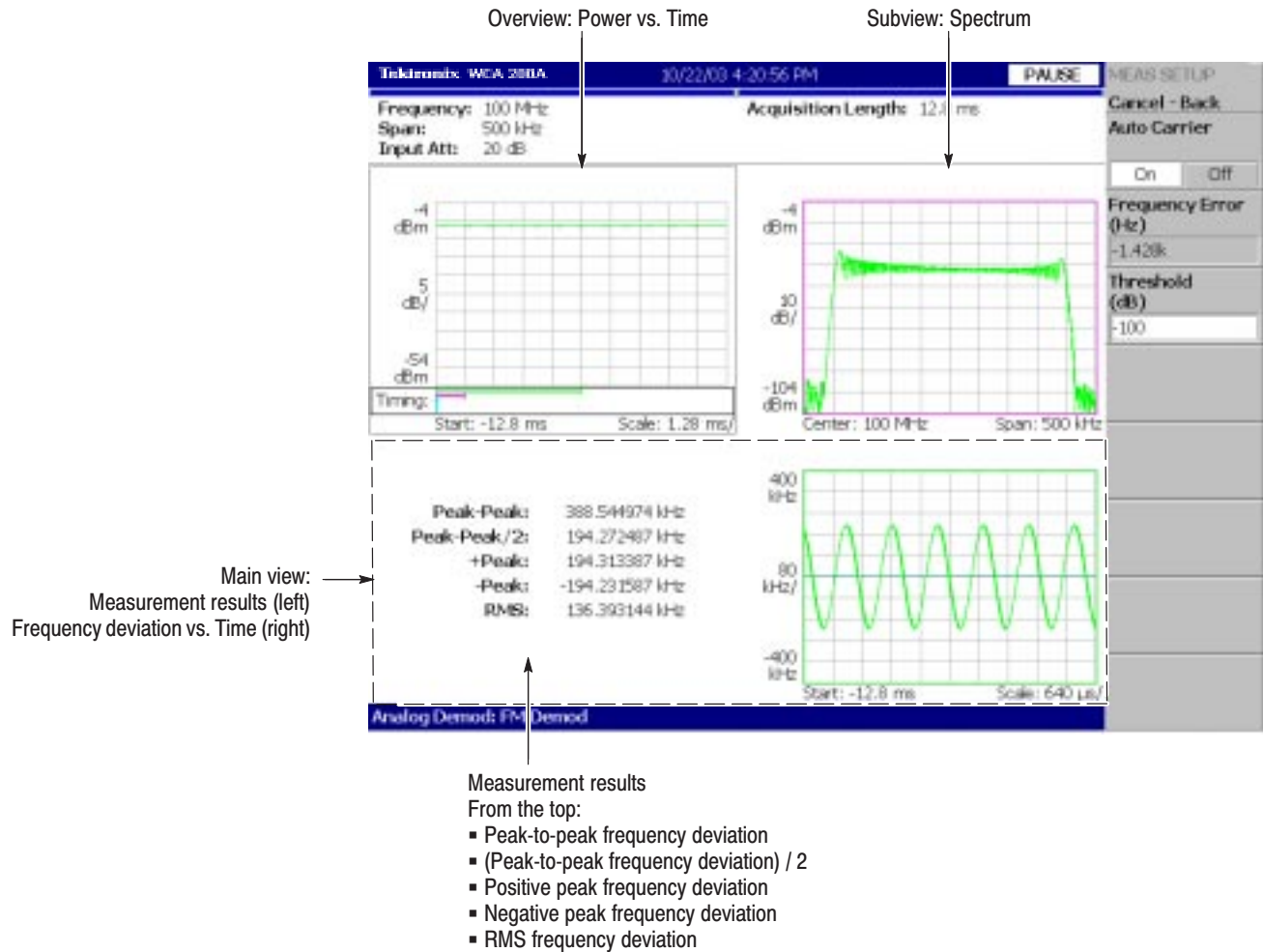

Figure 3-29: FM signal measurement

PM Signal Measurement

Measures PM signal. Figure 3–30 shows an example.

- Overview: Power vs. Time
- Subview: Spectrum
- Main view: Phase error vs. Time

Meas Setup Menu

The Meas Setup menu items for the PM signal measurement are as follows:

Threshold. Sets the threshold level above which the input signal is determined to be a burst in time domain. The burst detected first is used for the measurement.

Range: –100.0 to 0.0 dB.

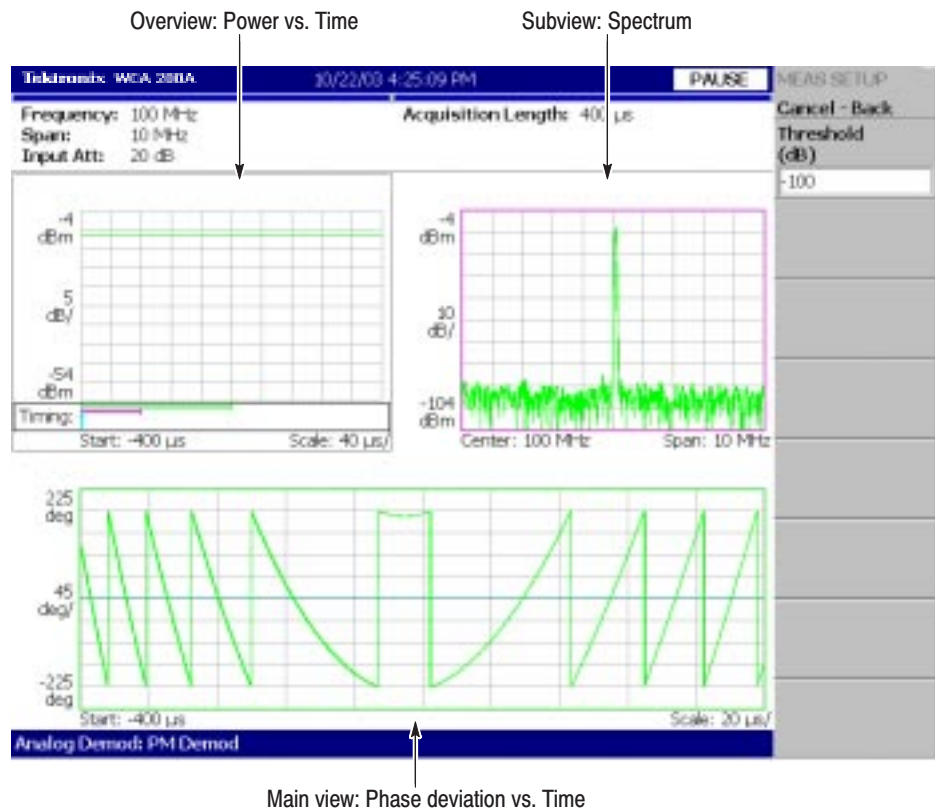

Figure 3–30: PM signal measurement

IQ Level Measurement

Measures the I and Q signal voltage change over time. Figure 3–31 shows the IQ Level measurement.

- Overview: Power vs. Time
- Subview: Spectrum
- Main view: I/Q voltage vs. Time
(I and Q are indicated in yellow and green, respectively)

The IQ level measurement has no Meas Setup menu items.

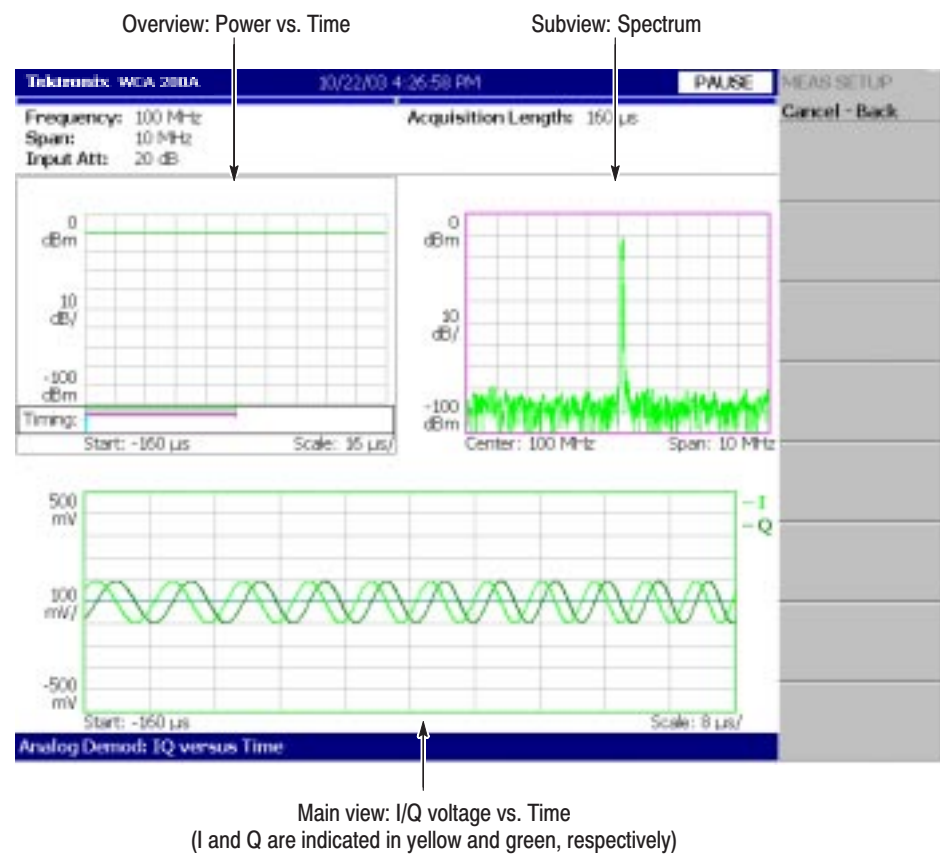

Figure 3–31: IQ level measurement

Digital Modulation Analysis

You can select following measurement items using the **MEASURE** key when you select **Digital Demod** in the Demod menu.

Table 3-7: Digital modulation analysis

MEASURE menu	Description
Constellation	Constellation analysis
EVM	EVM (Error Vector Magnitude) analysis
IQ/Freq vs. Time	I/Q level/frequency measurement
Symbol Table	Symbol table analysis
Eye Diagram	Eye diagram analysis

Meas Setup Menu

The Meas Setup menu items for the digital modulation analysis are as follows:

Parameter Presets... Selects a communication standard. Parameters are set according to the standard you have selected (refer to Table 3-8).

Modulation Type... Selects a modulation method: $1/4\pi$ QPSK, BPSK, QPSK, 8PSK, 16QAM, 32QAM, 64QAM, 256QAM, GMSK, or GFSK.

Modulation Parameters... Sets the following modulation parameters:

- **Symbol Rate.** Enters the symbol rate for demodulating digitally-modulated signals. Symbol rate and bit rate are related as follows:

$$(\text{Symbol rate}) = (\text{Bit rate}) / (\text{Number of bits per symbol})$$

For example, the number of bits per symbol is 3 for 8PSK.

- **Measurement Filter...** Selects a filter for demodulating digitally-modulated signal: None (no filter) or Root Raised Cosine.

Refer to *Process Flow of Digitally-Modulated Signals* on page 3-44 for details.

- **Reference Filter...** Select a filter for creating a reference signal: None (no filter), Raised Cosine, or Gaussian

Refer to *Process Flow of Digitally-Modulated Signals* on page 3-44 for details.

- **Filter Parameter.** Enters an α/BT value for the Measurement Filter and Reference Filter. The range is 0.0001 to 1.

Auto Carrier. Selects whether to use automatic carrier detection.

- **On. Default.** Automatically detects carriers for every frame and displays errors from center frequency as “Freq Error” on the screen.
- **Off.** Sets the carrier frequency using Frequency Error described below.

Frequency Error. Sets the carrier frequency when Off is selected in Auto Carrier. Input the carrier offset from the center frequency.

Table 3-8: Communication standard and parameters

Standard	Modulation	Symbol rate	Filter	α /BT
NADC	1/4 π QPSK	24.3 ksps	Root Raised Cosine	0.35
PDC	1/4 π QPSK	21 ksps	Root Raised Cosine	0.5
PHS	1/4 π QPSK	192 ksps	Root Raised Cosine	0.5
TETRA	1/4 π QPSK	18 ksps	Root Raised Cosine	0.35
GMS	GMSK	270.833 ksps	None	0.3
CDPD	GMSK	19.2 ksps	None	0.5
Bluetooth	GFSK	1 Msps	None	0.5

Process Flow of Digitally-Modulated Signals

To perform the necessary settings in digital modulation analysis, you must understand the digitally-modulated signal process in the analyzer.

Figure 3–32 outlines the process.

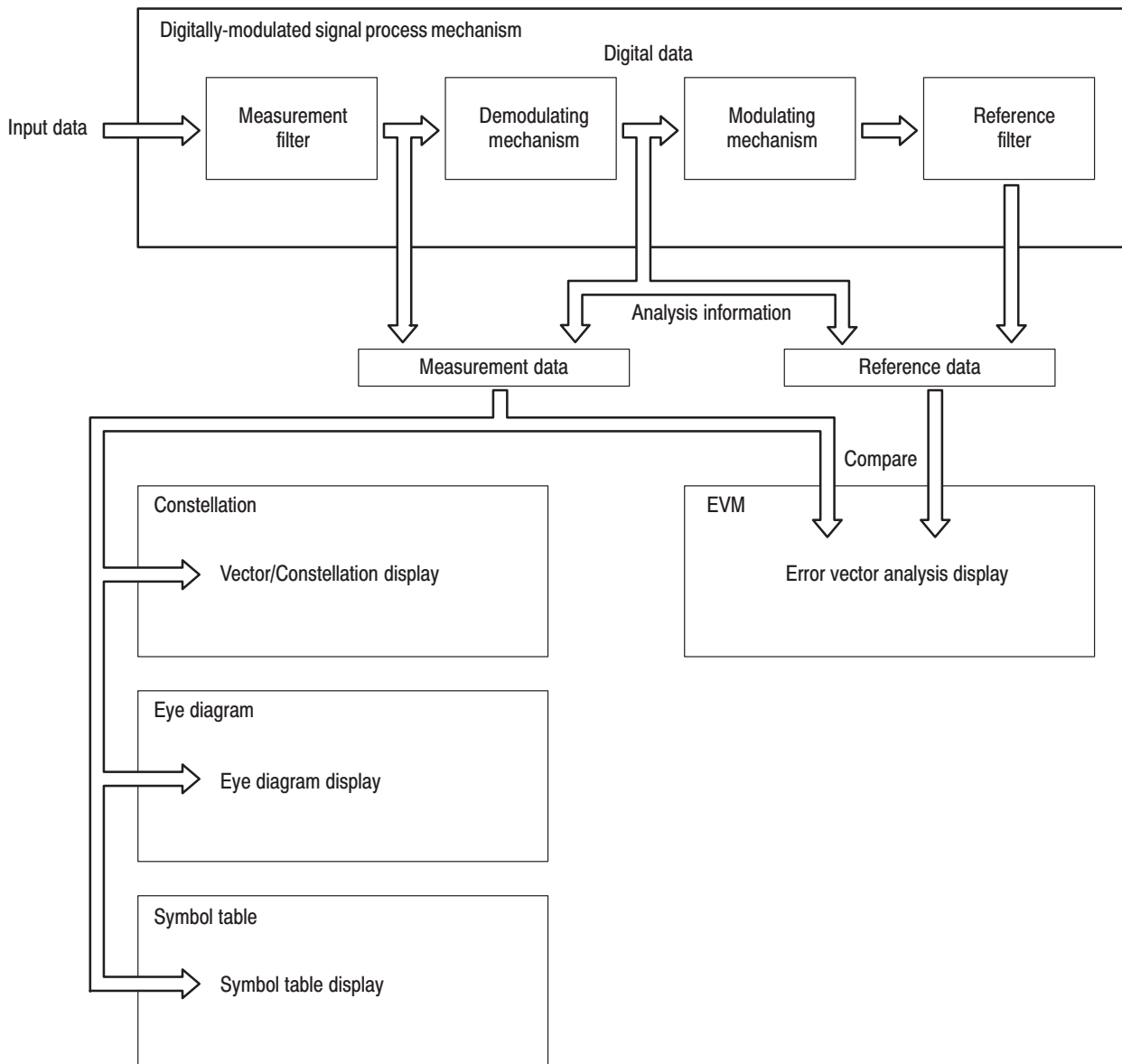

Figure 3–32: Process flow of a digitally-modulated signal

The input signal goes through the measurement filter after being converted into a digital signal, and then is stored as measurement data and is concurrently demodulated.

The demodulated signal is modulated again, goes through the reference filter, and is stored as reference data. The Vector/Constellation display, Eye Diagram, and Symbol Table are created based on measurement data, and the Error Vector Analysis display is created based on the comparison of measurement data and reference data.

Basic Procedure

Follow these steps to perform digital modulation analysis:

1. Press the MODE: **DEMODO** key on the front panel.
2. Press the **Digital Demod** side key.
3. Select the measurement item:
Constellation, EVM, IQ/Frequency vs. Time, Symbol Table, or Eye Diagram
4. Display the measurement waveform:

NOTE. *You should set appropriate frequency and span. It is important to set frequency and span as close to the measurement signal band as possible and finely adjust them. The modulated signal will not be recognized unless frequency and span are set appropriately.*

For information about setting frequency, span, and amplitude, refer to Setting Frequency and Span on page 3–79 and Setting Amplitude on page 3–87.

- a. Set the frequency by pressing the **FREQUENCY/CHANNEL** key on the front panel.
 - b. Set the span by pressing the **SPAN** key on the front panel.
 - c. Set the amplitude by pressing the **AMPLITUDE** key on the front panel.
5. Set analysis range by pressing the **TIMING** key on the front panel. Refer to page 3–29 for details of setting analysis range.
 6. Set the measurement parameters by pressing the **MEAS SETUP** key on the front panel. Refer to page 3–42 for the Meas Setup menu description.

If No Measurement Result or Waveform is Displayed on the Main View. Unless the analyzer obtains valid data for the measurement, the result or waveform does not appear on the main view. In this case, try the following steps:

- Set the center frequency to the middle of the measurement signal bandwidth.
- Set the span near to the measurement signal bandwidth.
- Set the data acquisition length (TIMING → Acquisition Length) larger to increase the number of data.

The following pages show examples for each measurement item.

Refer to page 3–63 for information about setting scale and formatting each view.

Refer to page 3–32 for information about changing the overview and subview.

Constellation Analysis

Performs digital demodulation processing and displays a constellation diagram. Figure 3–33 shows an example.

- Overview: Power vs. Time
- Subview: Spectrum
- Main view: Measurement results and Constellation

NOTE. In the constellation view, *I* and *Q* signals are normalized to prevent the scale from changing when signal attenuation changes.

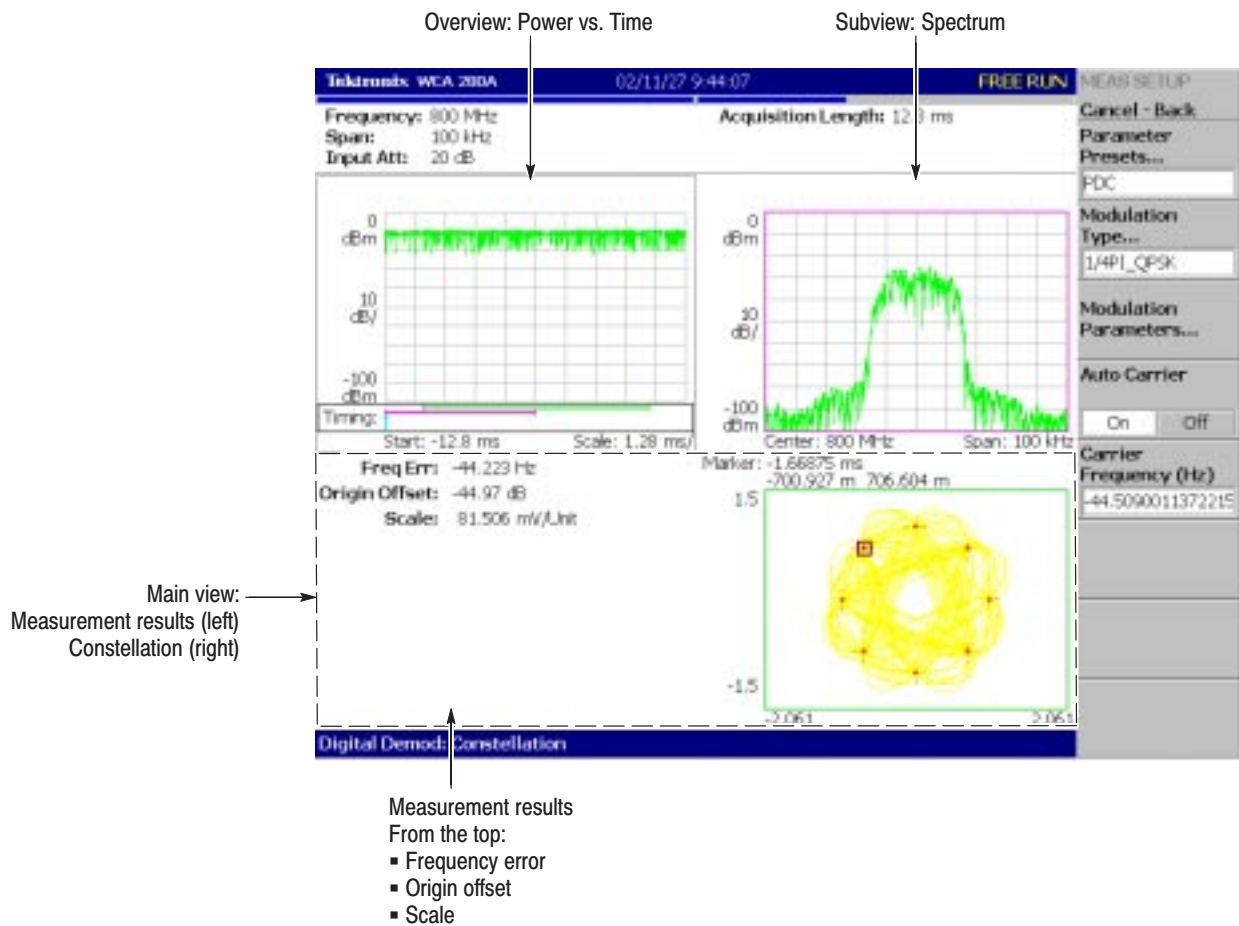

NOTE. "Origin offset" is also called "IQ feedthrough".

Figure 3–33: Constellation analysis

EVM Analysis

Measures EVM (Error Vector Magnitude). Figure 3–34 shows an example.

- Overview: Power vs. Time
- Subview: Spectrum
- Main view: Measurement results and EVM

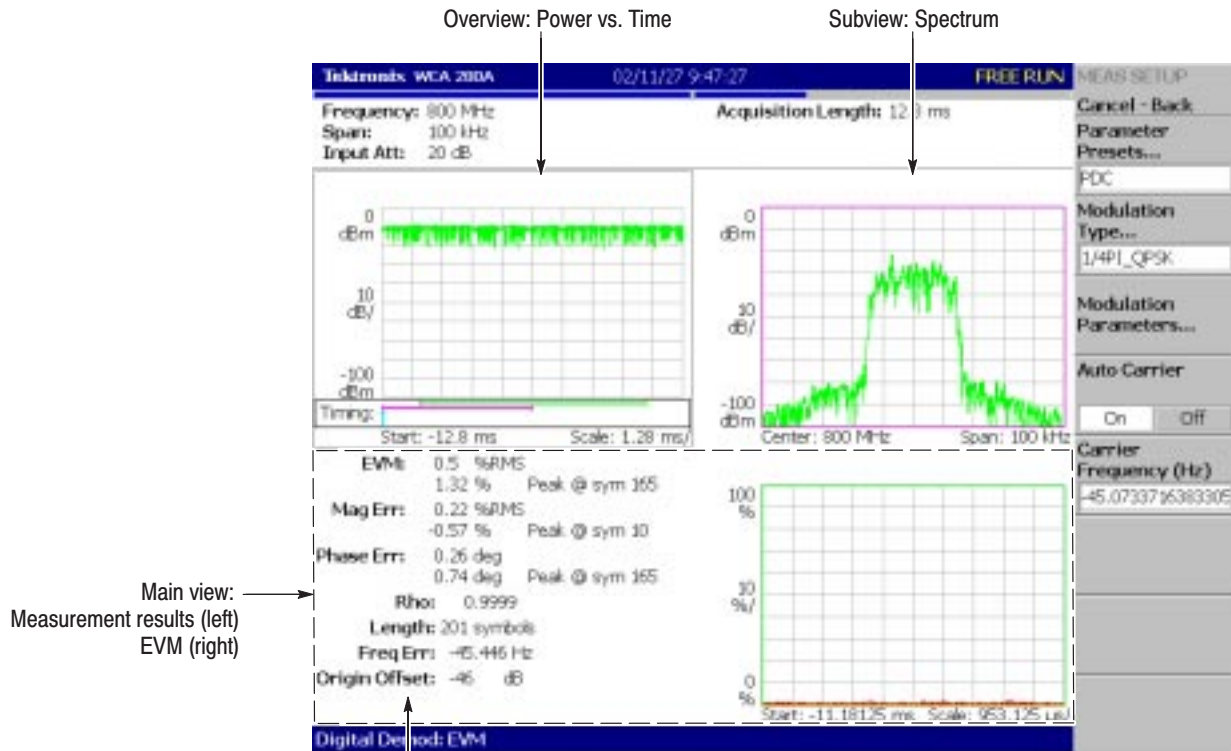

Measurement results from the top:

- EVM RMS
- Peak
- Magnitude error RMS
- Peak
- Phase error RMS
- Peak
- Waveform quality (Q)
- Symbol length
- Frequency error
- Origin offset

NOTE. "Origin offset" is also called "IQ feedthrough".

Figure 3–34: EVM analysis

IQ Level/Frequency Measurement

Observes I/Q signal voltage change over time. For GFSK modulation only, it displays frequency change over time. Figure 3–35 shows an example.

- Overview: Power vs. Time
- Subview: Spectrum
- Main view: I/Q voltage vs. Time (I and Q are indicated in yellow and green, respectively)

Main view: Frequency deviation vs. Time (GFSK only)

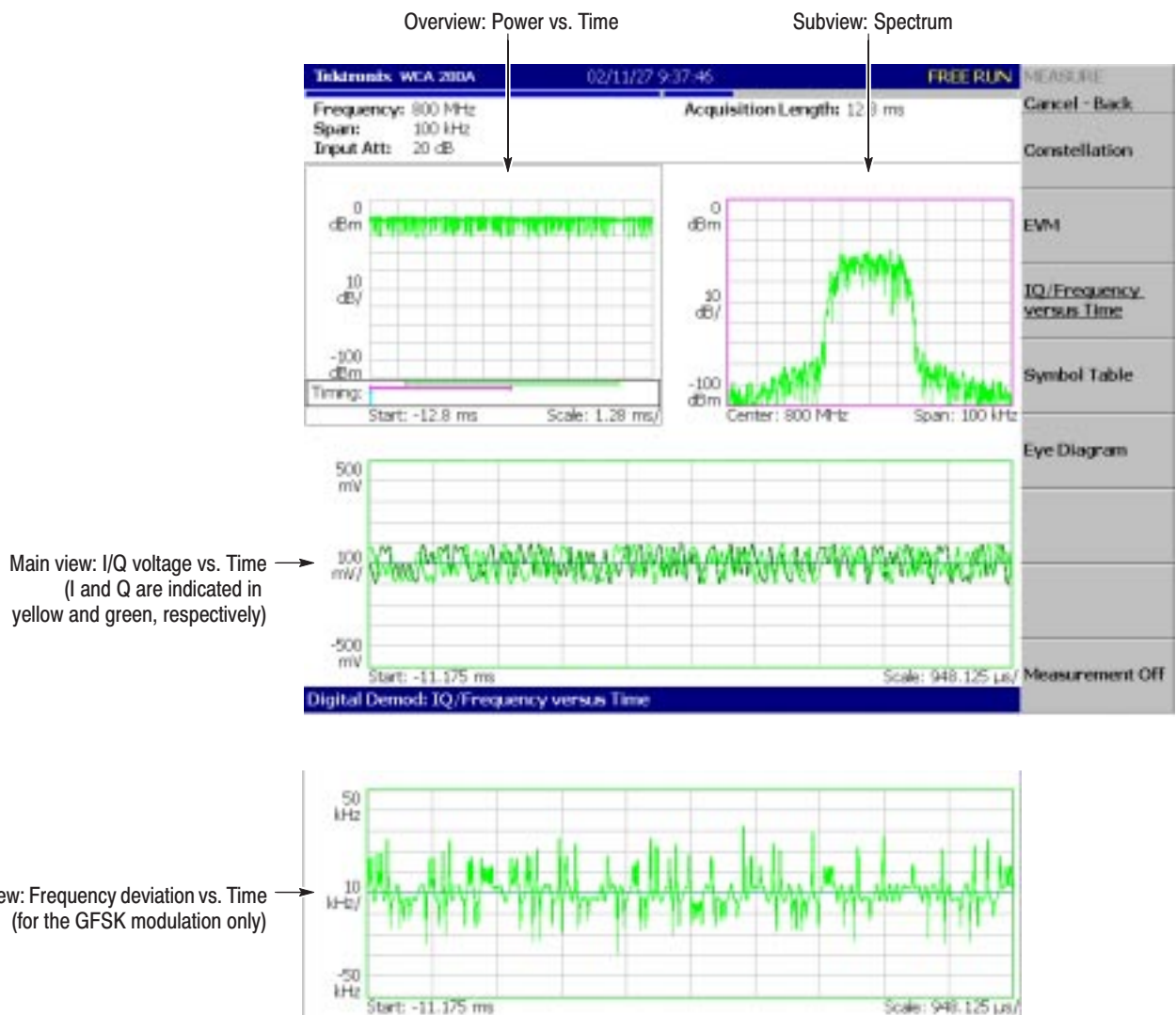

Figure 3–35: IQ level/frequency measurement

Symbol Table Analysis

Performs digital demodulation processing and displays a symbol table. Figure 3–36 shows an example.

- Overview: Power vs. Time
- Subview: Spectrum
- Main view: Symbol table

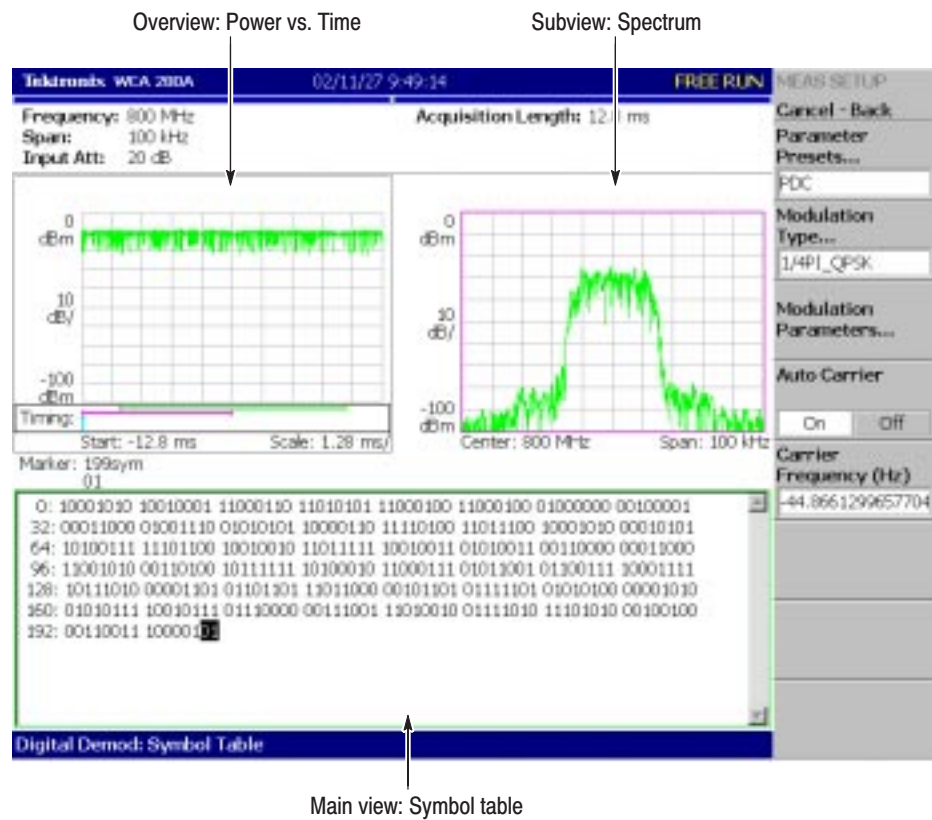

Figure 3–36: Symbol table analysis

Eye Diagram Analysis

Performs digital demodulation processing and displays an eye diagram. Figure 3–37 shows an example.

- Overview: Power vs. Time
- Subview: Spectrum
- Main view: Eye diagram

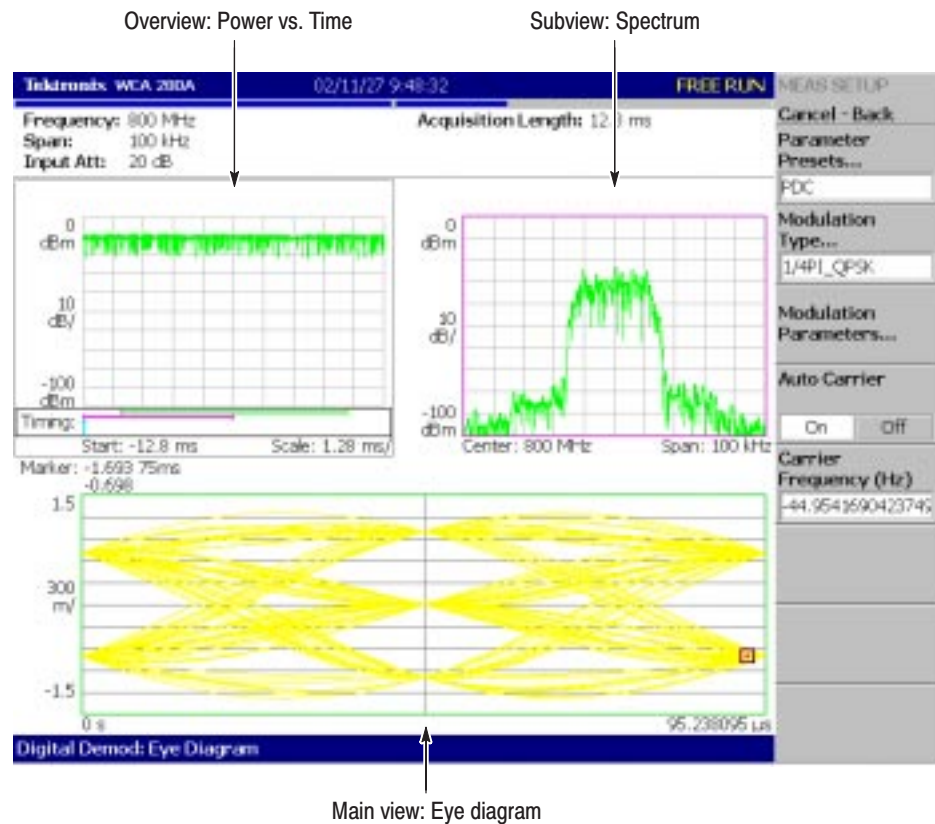
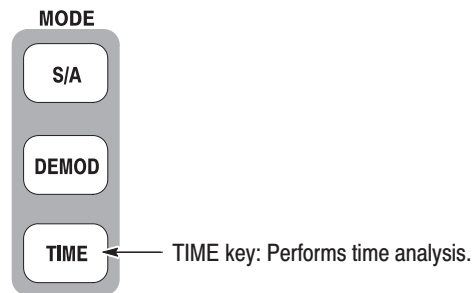

Figure 3–37: Eye diagram analysis

Time Analysis (Time Mode)

This section describes measurement methods in the time analysis (Time mode).



There are three items in the Time menu:

- **Transient:** Performs time variation measurement.
Refer to page 3–56 for details.
- **CCDF:** Performs CCDF measurement.
Refer to page 3–60 for details.

Measurement Screen Layout

In the Time mode, the following three views are displayed on screen by default (see Figure 3–38):

- **Overview:** Displays all data in one block. The Timing field on the bottom of the overview shows a “T” indicating a trigger point, a green horizontal line indicating a waveform analysis range in the main view, and a pink horizontal line indicating the FFT processing range for the spectrum in the subview.

For details about the trigger point, refer to *Trigger Point Indicator* on page 3–130.

- **Main view:** Displays measurement results and waveform for the range specified in the overview. The measurement results and waveform may be displayed separately.
- **Subview:** Spectrum is displayed by default as an auxiliary view. The FFT processing range can be specified in the overview.

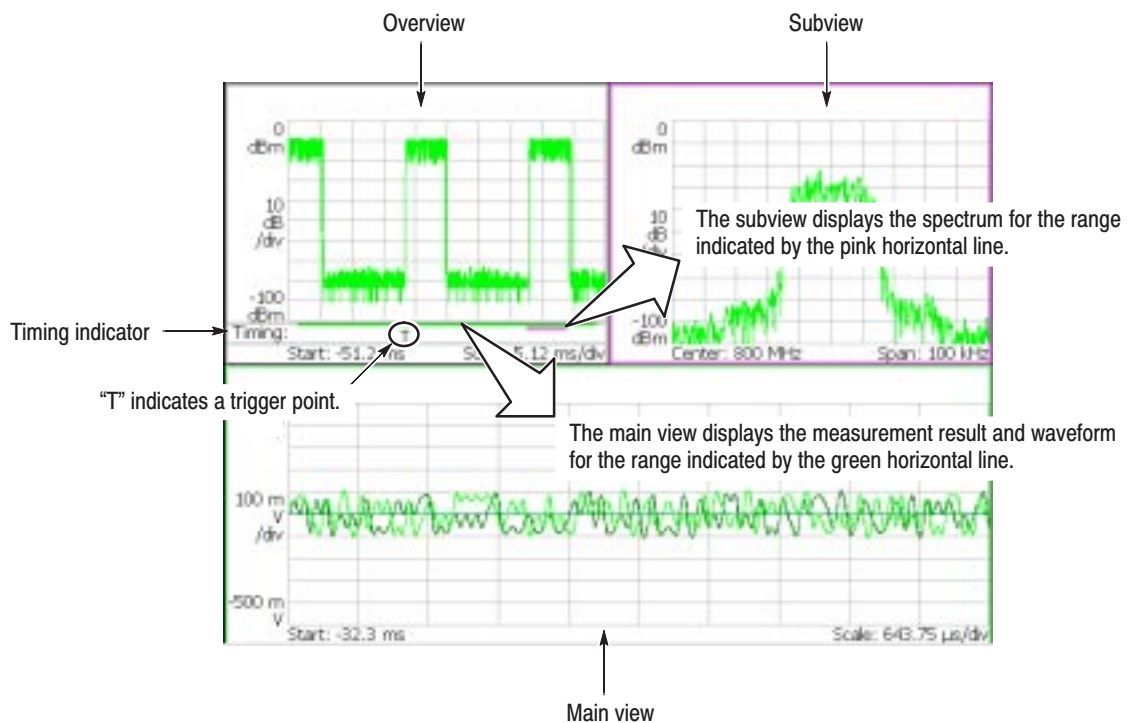

Figure 3–38: Time mode screen

The view definition is the same as in the DEMOD mode.
For setting the analysis range, refer to page 3–29.

For changing the overview, refer to page 3–32.
The subview selection is not available in the Time mode.

For one-view display, refer to page 3–34.

Time Variation Measurement

You can select the following time variation measurement items using the **MEASURE** key when you select **Transient** in the Time menu.

Table 3-9: Time variation measurement

MEASURE menu	Description
IQ versus Time	I/Q level measurement
Power versus Time	Power change measurement
Frequency versus Time	Frequency change measurement

The time variation measurements have no Meas Setup menu items.

Basic Procedure

Follow these steps to perform the time variation measurement:

1. Press the **MODE: TIME** key on the front panel.
2. Press the **Transient** side key and select the measurement item: IQ versus Time, Power versus Time, or Frequency versus Time.
3. Display the measurement waveform:

NOTE. You should set appropriate frequency and span. It is important to set frequency and span as close to the measurement signal band as possible and finely adjust them. The modulated signal will not be recognized unless frequency and span are set appropriately.

For details on setting frequency, span, and amplitude, refer to Setting Frequency and Span on page 3-79 and Setting Amplitude on page 3-87.

- a. Set the frequency by pressing the **FREQUENCY/CHANNEL** key on the front panel.
 - b. Set the span by pressing the **SPAN** key on the front panel.
 - c. Set the amplitude by pressing the **AMPLITUDE** key on the front panel.
4. Set the analysis range by pressing the **TIMING** key on the front panel. Refer to page 3-29 for details about setting analysis range.

The following pages show the examples for each measurement item. Refer to page 3-63 for information about setting scale and formatting each view. Refer to page 3-32 for information about changing the overview.

- I/Q Level Measurement** Observes I/Q signal voltage change over time. Figure 3–39 shows an example.
- Overview: Power vs. Time
 - Subview: Spectrum
 - Main view: I/Q voltage vs. Time
(I and Q are indicated in yellow and green respectively)

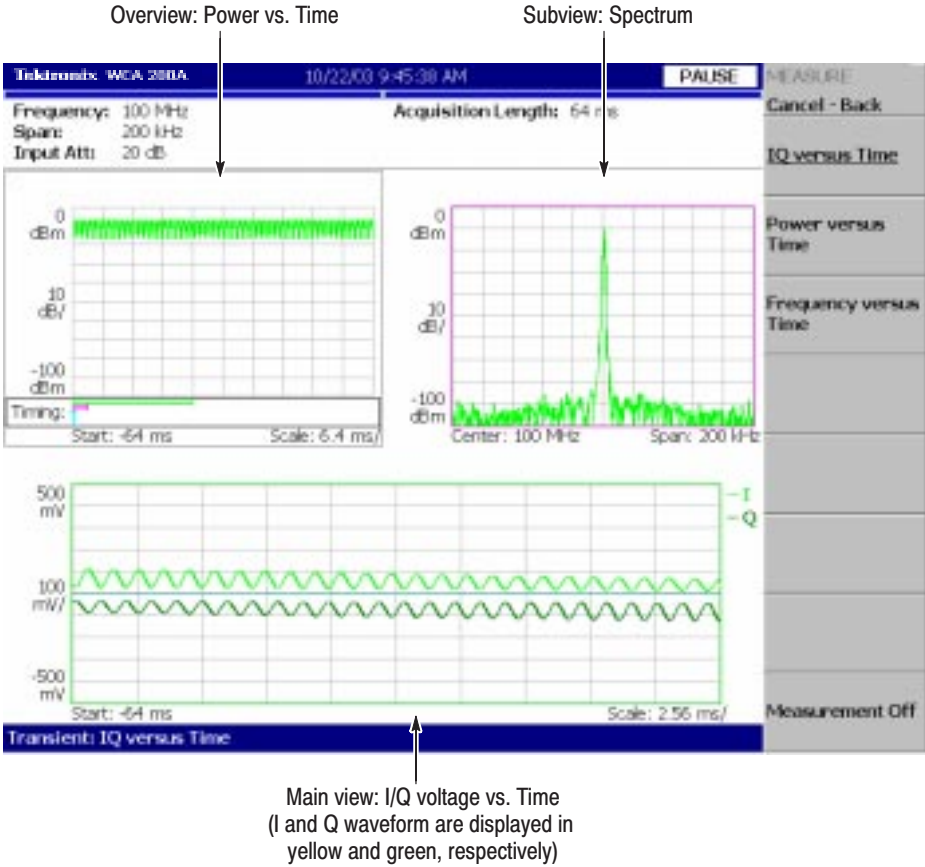

Figure 3–39: Example of IQ level change measurement

Power Change Measurement

Observes signal power change over time. Figure 3–40 shows an example.

- Overview: Power vs. Time
- Subview: Spectrum
- Main view: Power vs. Time

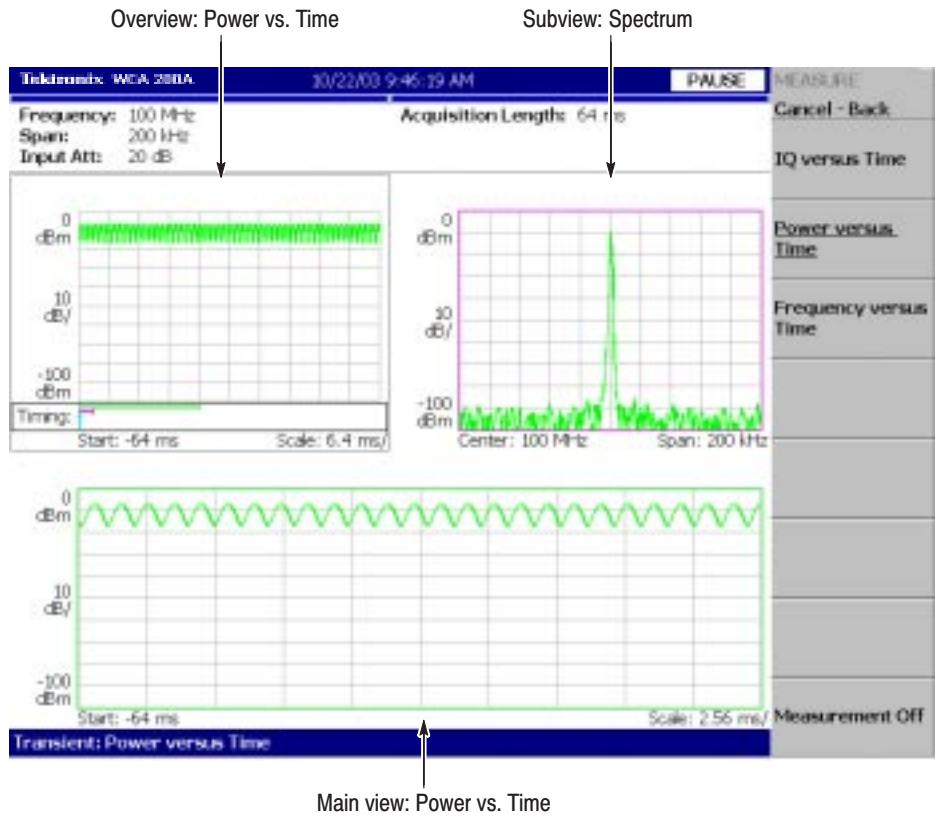

Figure 3–40: Power variance measurement

Frequency Change Measurement

Observes signal frequency change over time. Figure 3–41 shows an example.

- Overview: Power vs. Time
- Subview: Spectrum
- Main view: Frequency deviation vs. Time

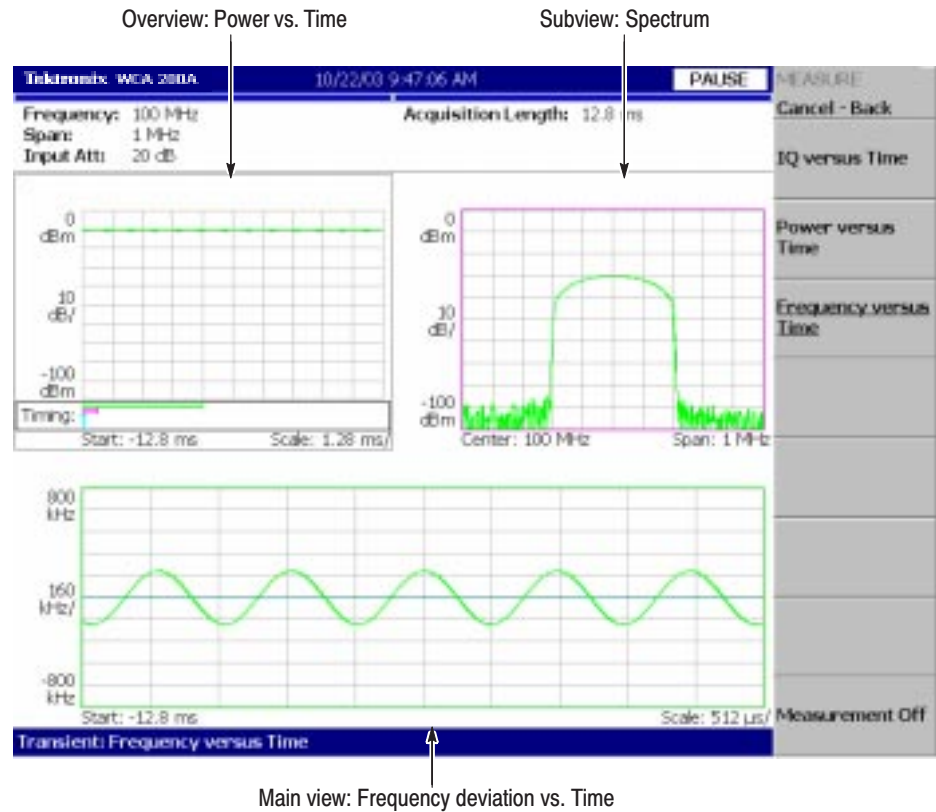

Figure 3–41: Frequency measurement

CCDF Measurement

CCDF (Complementary Cumulative Distribution Function) represents the probability that the peak power above average power of a measured signal exceeds a threshold. The analyzer displays the ratio of peak power to average power along the horizontal axis, and the probability that the ratio is exceeded along the vertical axis. This CCDF analysis function and the real-time analysis function allow you to measure the time-varying crest factor in the time series for code-multiplexing signals such as CDMA/W-CDMA signals, and multi-carrier signals such as OFDM signals. This function is useful in designing amplifiers for CDMA/W-CDMA and OFDM.

CCDF Calculation Process

In the CCDF analysis, obtain the distribution of amplitude of observed signals and make a graph of accumulation from the threshold. If the probability density of amplitude is supposed to be P, CCDF is calculated using this formula:

$$SP(X) = \int_X^{Max} P(Y) dY$$

$$CCDF(X) = SP(X + Average)$$

$$CCDF(crest\ factor) = 0$$

where
 P = Probability density
 Max = Maximum of amplitude
 Average = Average of amplitude

The analyzer processes input signals internally using the following procedure (see Figure 3-42):

1. Measure the amplitude of the input signal over time.
2. Determine the amplitude distribution.
3. Obtain CCDF using the above formula.

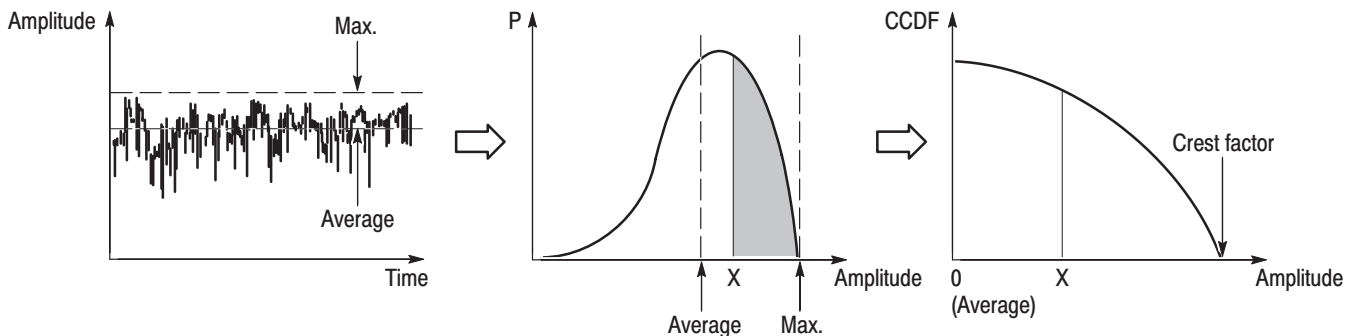

Figure 3-42: CCDF calculation process

Basic Procedure

Follow these steps to perform the CCDF measurement:

1. Press the **TIME** key on the front panel.
2. Press the **CCDF** side key.
3. Display the measured waveform.

NOTE. Make sure to set the proper frequency and span. It is important to set the frequency and the span as close to the measured signal bandwidth as possible and adjust minutely. If not, modulated signals are not recognized correctly.

For details about setting frequency, span, and amplitude, refer to Setting Frequency and Span on page 3–79 and Setting Amplitude on page 3–87.

- a. Press the **FREQUENCY/CHANNEL** key on the front panel to set the frequency.
- b. Press the **SPAN** key on the front panel to set the span.
- c. Press the **AMPLITUDE** key on the front panel to set the amplitude.
4. Set the analysis range by pressing the **TIMING** key on the front panel. Refer to page 3–29 for details about setting the analysis range.
5. Set the measurement parameters described just below by pressing the **MEAS SETUP** key on the front panel.

Meas Setup Menu

The following is the Meas Setup menu items for the CCDF measurement:

Reset Measurement. Performs CCDF calculation again from the beginning. Calculation is performed accumulatively until the Reset side key is pressed.

CCDF Auto-Scaling. Selects whether to fix the scale of the horizontal axis (amplitude) of CCDF graph display.

- **Off. Default.** The scale of the horizontal axis is set to a fixed value using CCDF Scale.
- **On.** Displays the graph with the signal peak value as the maximum value (right edge) of the horizontal axis.

CCDF Scale. Sets the full-scale of the horizontal axis of CCDF graph display when CCDF Auto Scaling is Off. Setting range: 1 to 100 dB

Measurement Example

Figure 3–43 shows an example of the CCDF measurement.

- Overview: Power vs. Time
- Subview: Spectrum
- Main view: CCDF

Refer to page 3–63 for setting scale and format of each view.
 Refer to page 3–32 for change of overview.

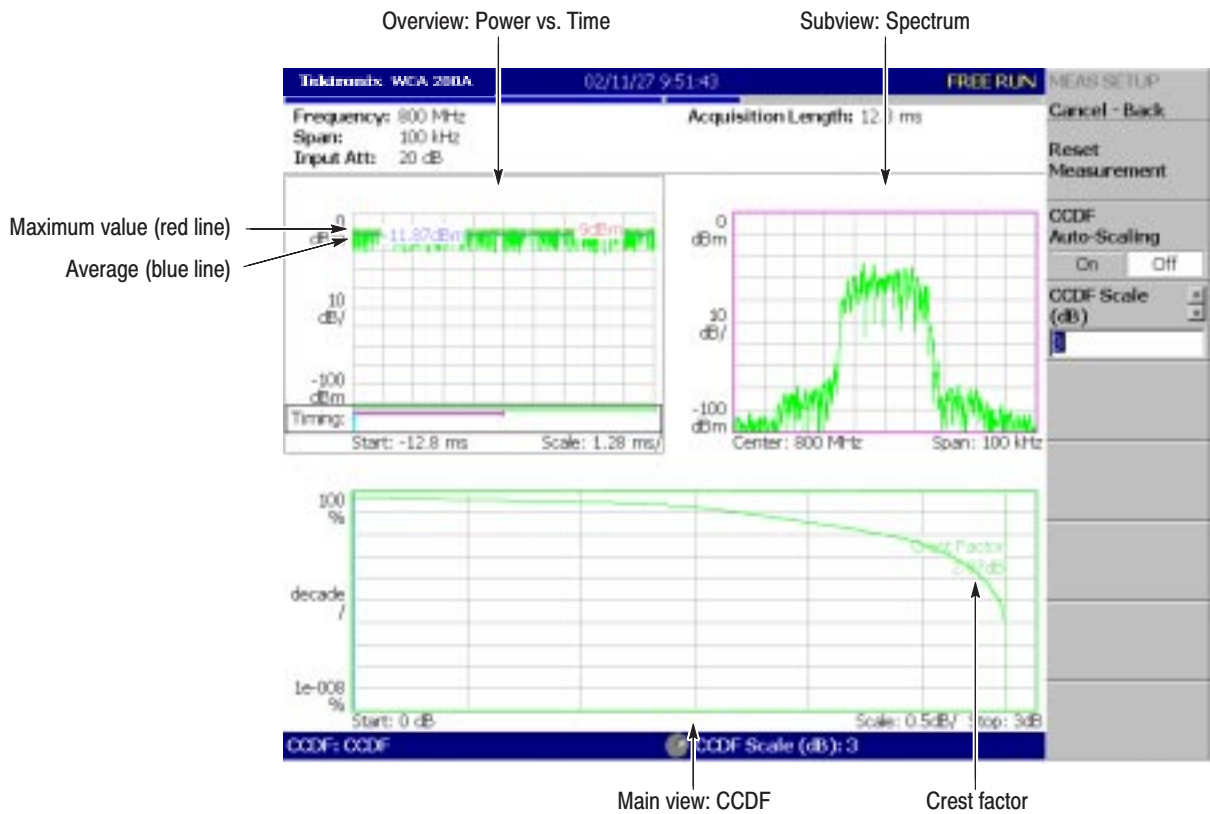

Figure 3–43: CCDF measurement

Scale and Format of Views

This section describes scaling and formatting for the following view types:

- Spectrum view
- Spectrogram view
- Time domain view
- CCDF view
- Constellation view
- EVM view
- Symbol table
- Eye diagram

Basic Procedure

The following procedures set the scale or format the view using the VIEW keys in single view or multiple views.

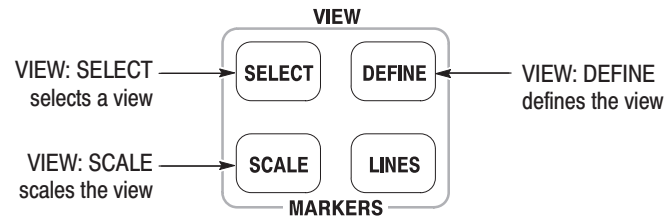

Procedure for Single View. When you are displaying one view on screen, press the VIEW: **SCALE** key and set the scale. For the Scale menu of specific views, refer to the following pages.

Procedure for Multiple Views. When you are displaying multiple views on the screen, follow these steps:

1. Select a view by pressing the VIEW: **SELECT** key.
The selected view is surrounded by a white frame.
2. If necessary, change a multiple view display to a single view display:
 - a. Press the VIEW: **DEFINE** key.
 - b. Press the **Show Views** side key to select **Single**.
Only the selected view will be displayed.
3. Set the scale by pressing the VIEW: **SCALE** key.
4. If necessary, return to the multiple view display:
 - a. Press the VIEW: **DEFINE** key.
 - b. Press the **Show Views** side key to select **Multi**.

Refer to page 3–32 for information about changing the overview and the subview with the Define menu.

Setting up the Spectrum View

In the spectrum view, the horizontal axis indicates frequency and the vertical axis indicates power.

View: Scale Menu The Scale menu for the spectrum view contains the following controls (see Figure 3-44):

Auto Scale. Sets the start value and the scale of the vertical axis automatically to display the entire waveform.

Horizontal Scale. Sets the scale of the horizontal axis.

Horizontal Start. Sets the minimum value (left edge) of the horizontal axis.

Vertical Scale. Sets the scale of the vertical axis.

Vertical Stop. Sets the maximum value (top edge) of the vertical axis.

Full Scale. Sets the scale of the vertical axis to the default full-scale value.

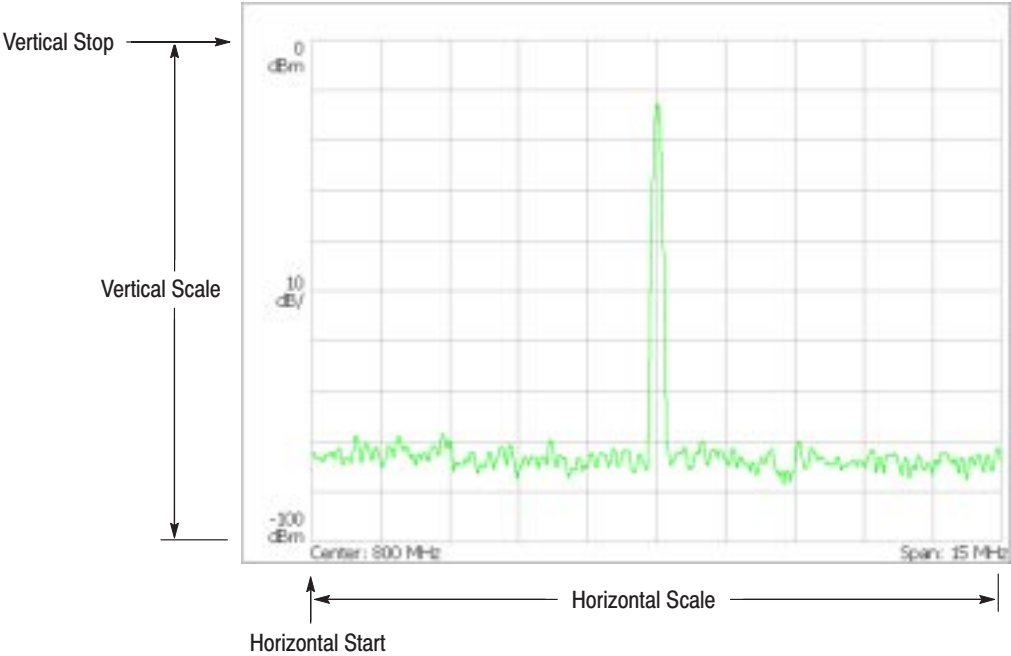

Figure 3-44: Setting the scale in spectrum view

Setting up the Spectrogram View

In the spectrogram view, the horizontal axis indicates frequency, the vertical axis indicates the frame number, and the color axis indicates power. This view and the scale menu appear when you select Real Time S/A in the S/A mode, or by changing the overview in the Demod and the Time modes.

NOTE. *When you select S/A with Spectrogram in the S/A mode, you cannot set the scale of the spectrogram.*

View: Scale Menu

The Scale menu for the spectrogram view contains the following controls (see Figure 3–45):

Auto Scale. Performs auto scaling. The start value and scale of the color axis are automatically set to display entire waveform.

Horizontal Scale. Sets the scale of the horizontal axis.

Horizontal Start. Sets the minimum value (left edge) of the horizontal axis.

Vertical Size. Sets the scale of the vertical axis. Range: 87 to 89088 frames.

Vertical Start. Sets the start frame number for the vertical axis.

Color Scale. Sets the scale (value subtracting the minimum power value from the maximum power value) of the color axis. The level is represented in 100 steps (100 colors) from the minimum value (blue) to the maximum value (red) in the default state.

Color Stop. Sets the maximum value (top edge) of the color axis.

Full Scale. Sets the maximum value of the color axis to the reference level and the height to 100 dB.

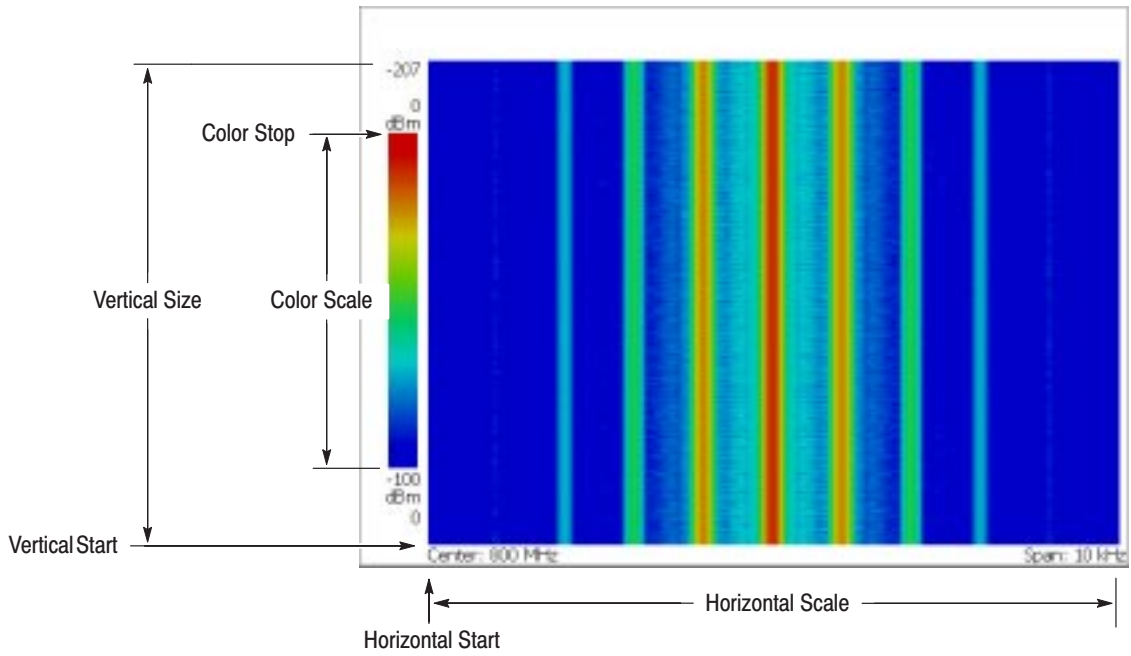

Figure 3-45: Scale and format settings in spectrogram view

Setting up the Time Domain View

The time domain view includes the following five displays shown on the overview or the main view in the Demod and the Time modes:

- Power versus Time
- AM demodulation display (modulation factor versus time)
- FM demodulation display (frequency deviation versus time)
- PM demodulation display (phase deviation versus time)
- I/Q level versus Time

View: Scale Menu

The Scale menu for the time domain view contains the following controls (see Figure 3–46):

Auto Scale. Sets the start value and the scale of the vertical axis automatically to display the entire waveform.

Horizontal Scale. Sets the scale of the horizontal axis.

Horizontal Start. Sets the minimum value (left edge) of the horizontal axis.

Vertical Scale. Sets the scale of the vertical axis.

Vertical Stop. Available when the vertical axis represents power.
Sets the maximum value (top edge) of the vertical axis.

Vertical Offset. Available when the vertical axis represents AM modulation factor, FM frequency deviation, PM phase deviation, or IQ voltage.
Sets the center value $((\text{maximum} + \text{minimum}) / 2)$ of the vertical axis.

Full Scale. Sets the scale and start value of the vertical axis to the default full-scale value.

Vertical axis: Power

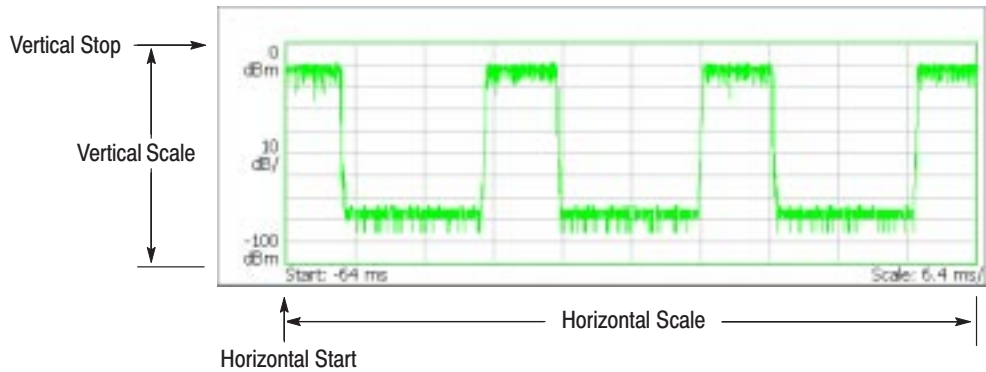

Vertical axis: AM modulation factor, FM frequency deviation, PM phase deviation, or IQ level
 (An example of the AM modulation factor below)

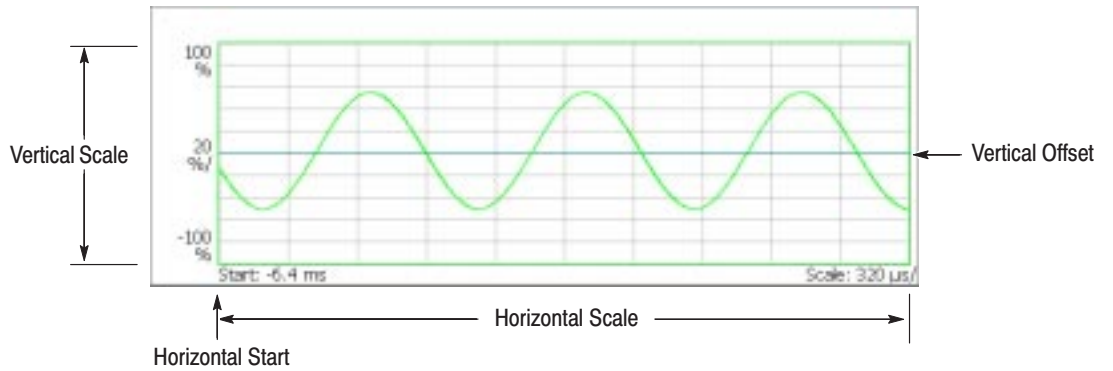

Figure 3-46: Setting the scale in time domain view

Setting up the CCDF View

In the CCDF view, the horizontal axis indicates amplitude and the vertical axis (logarithmic scale) indicates CCDF. The CCDF measurement in the time analysis (Time mode) is used for display (refer to page 3–60).

View: Scale Menu

The Scale menu for the CCDF view contains the following controls (see Figure 3–47):

Auto Scale. Sets the start value and the scale of the vertical axis automatically to display the entire waveform.

Horizontal Scale. Sets the scale of the horizontal axis.

Horizontal Start. Sets the minimum value (left edge) of the horizontal axis.

Vertical Stop. Sets the maximum value (top edge) of the vertical axis.
Range: Twice of the Vertical Start value to 100% in a 1-2-5 sequence.

Vertical Start. Sets the minimum value (bottom edge) of the vertical axis.
Range: 10^{-9} to 1/2 of the Vertical Stop value in a 1-2-5 sequence.

Full Scale. Sets the vertical axis scale to the default full-scale value.

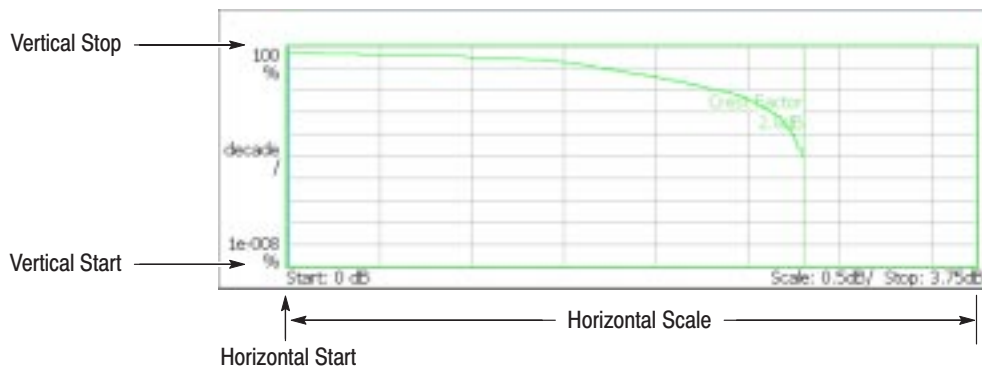

Figure 3–47: Setting the scale in CCDF view

Setting up the Constellation View

The signal represented by phase and amplitude is displayed in polar coordinate or IQ diagram in the constellation view. You can display this view in the constellation analysis of the digital modulation analysis (refer to page 3–47).

The constellation displays I and Q components of the signal in 2 dimensions. As the overall signal level changes, both I and Q are automatically scaled to keep the size of the constellation relatively constant from one update to the next. This new scale is then normalized to a unitless scale.

View: Scale Menu

The Scale menu for the constellation view contains the following controls (see Figure 3–48):

Measurement Content... Selects vector or constellation display (see Figure 3–48).

- **Vector.** Selects vector display. Signals represented by phase and amplitude (such as digitally-modulated signals) are shown in a polar coordinate or IQ diagram. The red point indicates symbol position of the measurement signal and the yellow trace indicates the locus of the signal between symbols. The magnitude of the error vector is evaluated by comparing the point where yellow traces are concentrated to the red point. The cross marks indicate symbol positions of the ideal signal.
- **Constellation.** Selects the constellation display. It is the same as the vector display, except that only symbols of the measurement signal are indicated in red, and the locus between symbols is not displayed.

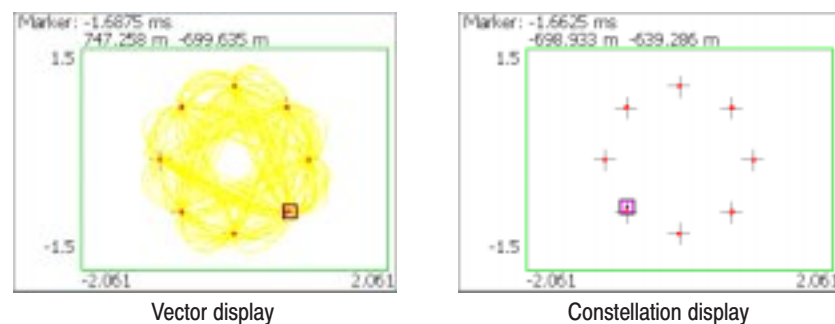

Figure 3–48: Vector and constellation displays

Setting up the EVM View

The horizontal axis indicates time, and the vertical axis indicates EVM, amplitude, or phase in the EVM view. You can display this view in EVM analysis of the digital modulation analysis (refer to page 3–48).

View: Scale Menu

The Scale menu for the EVM view contains the following controls (see Figure 3–49):

Auto Scale. Sets the start value and the scale of the vertical axis automatically to display the entire waveform.

Horizontal Scale. Sets the scale of the horizontal axis.

Horizontal Start. Sets the minimum value (left edge) of the horizontal axis.

Vertical Scale. Sets the scale of the vertical axis.

Vertical Start. Available when the vertical axis represents EVM. Sets the minimum value (bottom edge) of the vertical axis.

Vertical Offset. Available when the vertical axis represents magnitude or phase error. Sets the center value $((\text{maximum} + \text{minimum}) / 2)$ of the vertical axis.

Full Scale. Sets the scale and start value of the vertical axis to the default full-scale value.

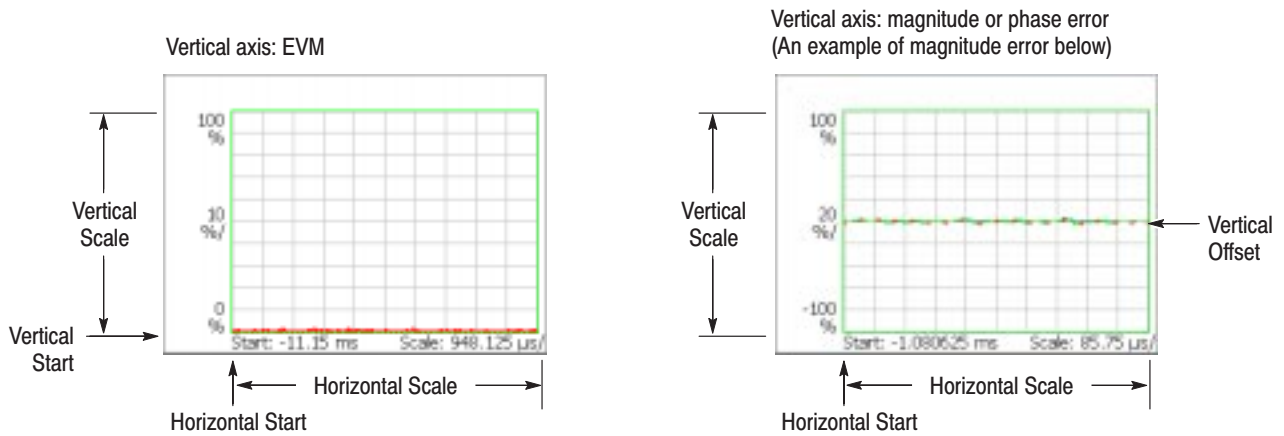

Figure 3-49: Setting the scale in the EVM view

Measurement Content... Selects one of the following formats for the view (see Figure 3-50).

- **EVM.** Displays changes of EVM (Error Vector Magnitude) in time series.
- **Mag Error.** Displays changes of magnitude error in time series.
- **Phase Error.** Displays changes of phase error in time series.

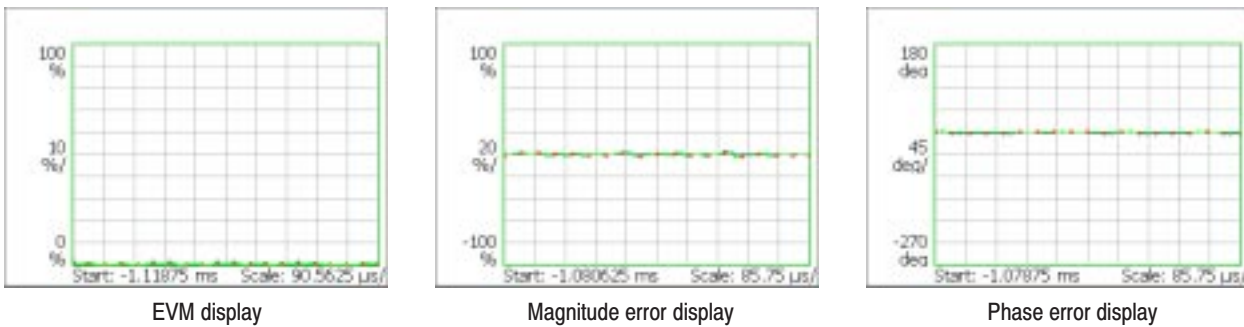

Figure 3-50: EVM, magnitude and phase error displays

See Figure 3–51 for EVM, Mag Error, and Phase Error. The figure is an example of constellation view in $1/4\pi$ QPSK modulation. The cross marks are referred to as symbols and indicate phase positions of the ideal signal (amplitude is fixed in this case). The bit pattern is defined by movements from each position in this modulation. For example, if the actual signal has shifted from the ideal symbol position to the ● position, you can evaluate vector signal quality as magnitudes of error in radius direction (amplitude), error in phase direction, and the total error vector. These three types of errors correspond to the three types of views in the EVM view:

- EVM (%RMS): Root-mean-square value of EVM (Error Vector Magnitude)
- Mag Error (%RMS): Root-mean-square value of magnitude error
- Phase Error (%RMS): Root-mean-square value of phase error

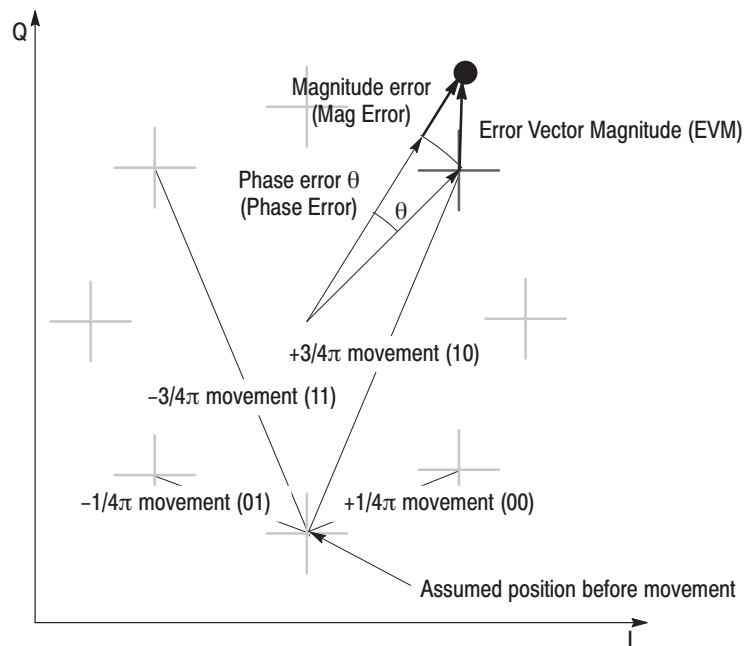

Figure 3–51: Constellation view and error vectors in $1/4\pi$ QPSK

Setting up the Symbol Table

In the symbol table, the horizontal axis indicates time and the vertical axis indicates amplitude or phase. You can display this table in the symbol table analysis in the digital modulation analysis (refer to page 3–50).

View: Scale Menu The Scale menu for the symbol table contains the following controls (see Figure 3–52):

Radix. Selects the radix for displaying the table from hexadecimal digit (Hex), octal digit (Oct), and binary digit (Bin).

Rotate. Sets the value start position. The setting range is 0 to 3. This item is invalid in $1/4\pi$ QPSK and GMSK modulations because absolute coordinates have no meaning.

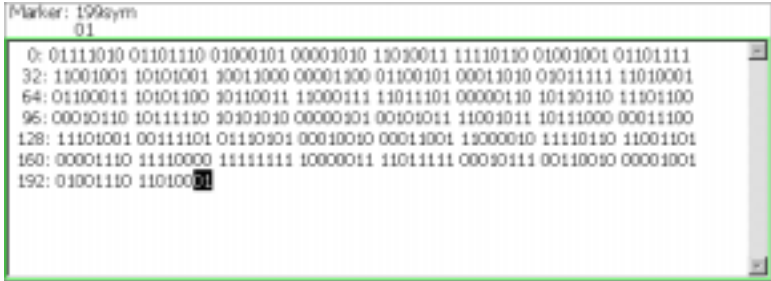

Figure 3–52: Symbol table

Setting up the Eye Diagram

In the eye diagram, the horizontal axis indicates time and the vertical axis indicates amplitude or phase. You can display this diagram in the eye diagram analysis in the digital modulation analysis (refer to page 3–51).

View: Scale Menu The Scale menu for the eye diagram contains the following controls:

Measurement Content... Selects the vertical axis of the eye diagram (see Figure 3–53).

- **I.** Displays I data on the vertical axis (default).
- **Q.** Displays Q data on the vertical axis.
- **Trellis.** Indicates phase on the vertical axis.

Eye Length. Enters the number of display symbols on the horizontal axis defining the time required for movement between symbols as 1.
Range: 1 to 16 (default: 2)

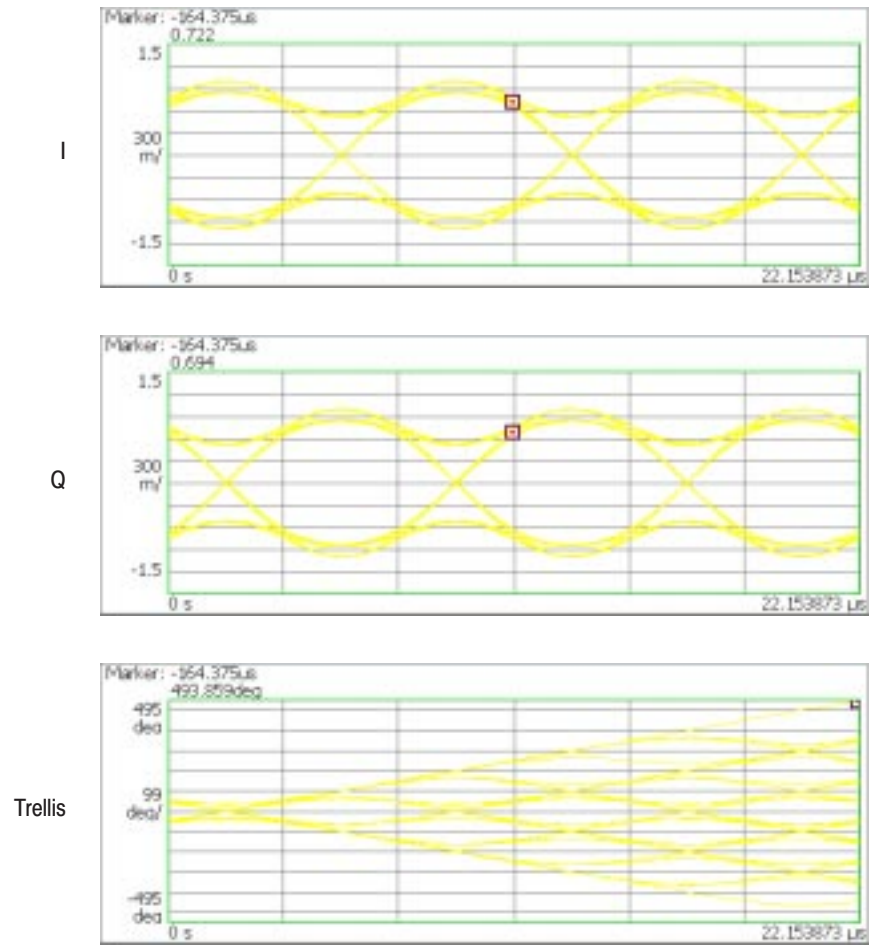
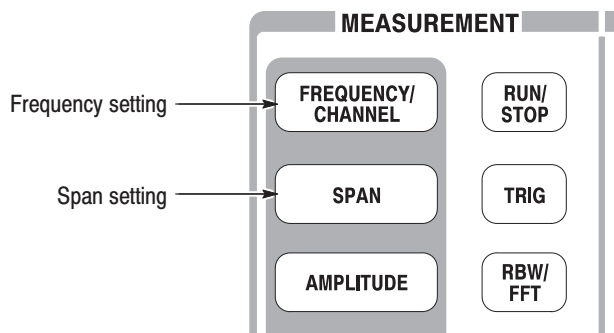

Figure 3-53: Example of eye diagram view

Setting Frequency and Span

This section describes frequency and span, which are fundamental settings for observing the spectrum. These items are set using the general purpose knob and the numeric input keypad. You can also use the marker peak search function to set frequency.

To set frequency and span, use the large keys on the left side of the front panel.



Basic Procedure

Use the following steps to set the frequency and span:

1. Press the **FREQUENCY/CHANNEL** key on the front panel.
2. Set the center frequency using the **Center Freq** side key (see Figure 3–54).
The following two items are available in the S/A mode:
 - **Start Freq** sets the minimum value of the frequency axis.
 - **Stop Freq** sets the maximum value of the frequency axis.
3. Press the **SPAN** key on the front panel.
4. Select the span using the **Span** side key.

Using the up/down keys, you can set the span in the 1-2-5 sequence.
Using the general purpose knob, you can set the span in 1-2-5 or finer increments, depending on the mode.

The relationship between the parameters is: $(\text{Stop Freq}) - (\text{Start Freq}) = (\text{Span})$.
The settings for center, start, and stop frequencies are related to the setting for span; when one parameter is changed, the other is changed automatically.

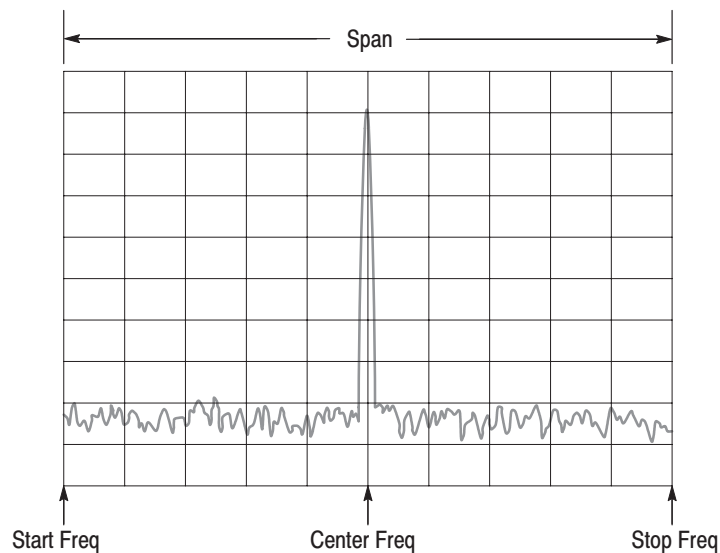

Figure 3-54: Setting frequency and span

For information about how to change the step size (amount per press by which the up/down keys change the setting), refer to *Changing the Step Size* on page 2–15.

Using the Channel Table

The channel table contains channel numbers and the corresponding frequencies for a communication system. When you use W-CDMA standard signals, for example, you can set a center frequency by selecting a channel number from the W-CDMA table.

1. Press the **FREQUENCY/CHANNEL** key on the front panel.
2. Press the **Channel Table...** side key and select one of these items:

None selects no channel table.

You can select one of the following communication standards:

CDMA2000 EU PAMR400-FL	CDMA2000 EU PAMR400-RL
CDMA2000 EU PAMR800-FL	CDMA2000 EU PAMR800-RL
CDMA2000 GSM BAND 1-FL	CDMA2000 GSM BAND 1-RL
CDMA2000 GSM BAND 2-FL	CDMA2000 GSM BAND 2-RL
CDMA2000 IMT2000-FL	CDMA2000 IMT2000-RL
CDMA2000 JTACS BAND-FL	CDMA2000 JTACS BAND-RL
CDMA2000 KOREA PCS-FL	CDMA2000 KOREA PCS-RL
CDMA2000 N.A. 700MHz Cellular-FL	
CDMA2000 N.A. 700MHz Cellular-RL	
CDMA2000 N.A. Cellular-FL	CDMA2000 N.A. Cellular-RL
CDMA2000 N.A. PCS-FL	CDMA2000 N.A. PCS-RL
CDMA2000 NMT450 20k-FL	CDMA2000 NMT450 20k-RL
CDMA2000 NMT450 25k-FL	CDMA2000 NMT450 25k-RL
CDMA2000 SMR800-FL	CDMA2000 SMR800-RL
CDMA2000 TACS BAND-FL	CDMA2000 TACS BAND-RL
DCS1800-DL	DCS1800-UL
GSM850-DL	GSM850-UL
GSM900-DL	GSM900-UL
NMT450-DL	NMT450-UL
PCS1900-DL	PCS1900-UL
W-CDMA-DL	W-CDMA-UL

FL: Forward link; RL: Reverse link; UL: Uplink; DL: Downlink

3. Press the **Channel** side key and select a channel number.

For example, when selecting channel 10551 in the W-CDMA downlink table, the center frequency is automatically set to 2.1102 GHz.

Using the Marker and Peak Search

You can use the search function to position the marker on the spectrum peak and then set the center frequency to the frequency at the marker, as shown in Figure 3–55.

In S/A Mode. You can set the peak spectrum to the center frequency using the marker search functions when the measurement mode is S/A (spectrum analysis).

1. Display the spectrum on the screen.
2. Press the **PEAK** key on the front panel. The maximum peak spectrum is detected and the marker is moved to that point.

Use the arrow keys (◀▶ ▲ ▼) to move the marker to another peak.

3. Press the **MARKER** ➡ key and then the **Center Freq = Marker Freq** side key. The center frequency is set to the frequency at the marker position.

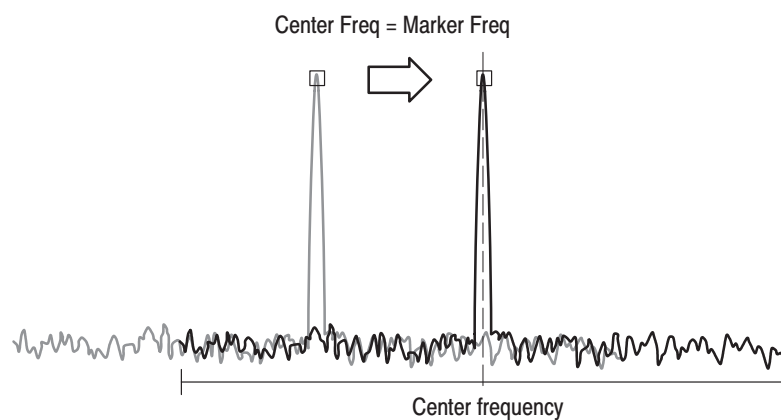

Figure 3–55: Setting the center frequency using MARKER ➡

The frequency set in this procedure may not take effect with all span settings. Refer to the *Setting Range* on page 3–83.

In Demod and Time Modes. The **MARKER** ➡ key is used to set the analysis range when the measurement mode is Demod or Time (modulation and time analyses). Refer to *Layout of the Measurement Screen* on page 3–28 for details.

In the overview of spectrogram or the subview of spectrum, you can use the **Center Freq = Marker Freq** side key as in the S/A mode described above.

Setting Range

Frequency bands are defined as shown in Table 3–10, based on the analyzer hardware architecture. The frequency band is switched automatically by a frequency setting. Span setting range depends on the frequency band and the measurement mode (S/A, Demod, or Time).

Table 3–10: Frequency and span setting range

Measurement mode	Frequency band	Frequency range	Span setting range
S/A (except real-time)	Baseband	DC to 20 MHz	50 Hz to 20 MHz (1-1.2-1.5-2-2.5-3-4-5-6-8 sequence)
	RF (WCA230A)	15 MHz to 3 GHz	50 Hz to 3 GHz (1-1.2-1.5-2-2.5-3-4-5-6-8 sequence)
	RF1 (WCA280A)	15 MHz to 3.5 GHz	
	RF2 (WCA280A)	3.5 to 6.5 GHz	
	RF3 (WCA280A)	5 to 8 GHz	
Real Time S/A Demod, Time	Baseband	DC to 20 MHz	100 Hz to 20 MHz (1-2-5 sequence)
	RF (WCA230A)	15 MHz to 3 GHz	100 Hz to 10 MHz (1-2-5 sequence) and 15 MHz
	RF1 (WCA280A)	15 MHz to 3.5 GHz	
	RF2 (WCA280A)	3.5 to 6.5 GHz	
	RF3 (WCA280A)	5 to 8 GHz	

In Demod and Time modes, the frequency and span settings must meet the following conditions:

$$\begin{aligned} &(\text{Center frequency}) + (\text{Span})/2 \\ &\leq \text{Upper limit of the frequency setting range (RF mode)} \\ &\leq 20 \text{ MHz (Baseband)} \end{aligned}$$

$$\begin{aligned} &(\text{Center frequency}) - (\text{Span})/2 \\ &\geq \text{Lower limit of the frequency setting range (RF mode)} \\ &\geq 0 \text{ Hz (Baseband)} \end{aligned}$$

When you enter an out-of-range value, the value is limited based on these conditions. In spectrum analyzer mode, the out-of-range values are allowed, but part of the trace may not be displayed because the analyzer cannot acquire that part of the waveform (see Figure 3–56).

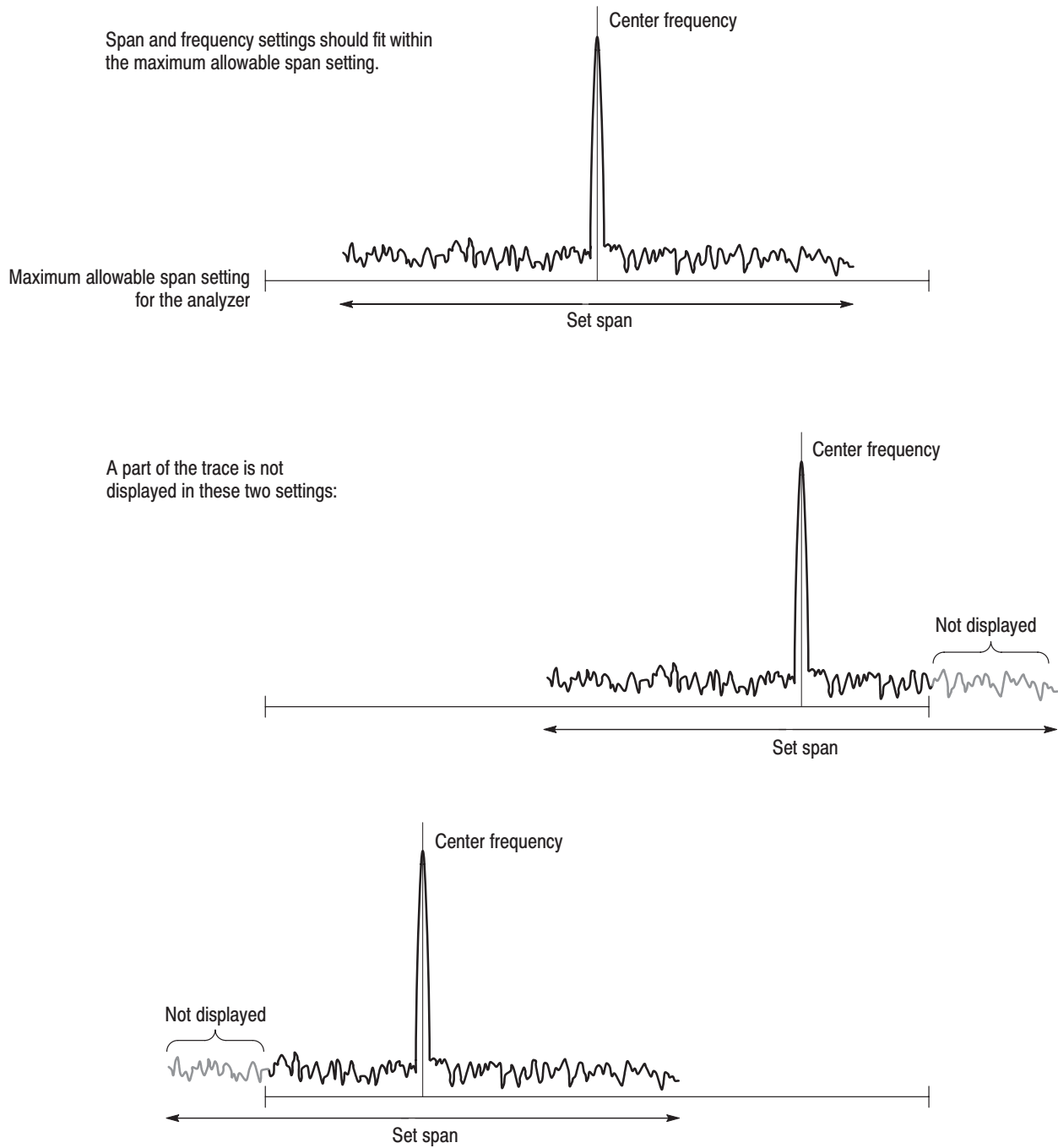

Figure 3-56: Relationship between the frequency and span settings

Vector Span

The input signals are scanned in frame units (one frame = 1024 points). There are two frames: a physical frame to store scanned data and a logical frame to store display data, as illustrated in Figure 3–57.

In the baseband, one logical frame is acquired at one scan regardless of the span setting. You can acquire one logical frame with one scan of a span setting below 15 MHz in the RF band. In larger spans, one logical frame is built up by acquiring data with multiple physical frames. For example, when the span is 30 MHz, one logical frame is composed from two (30 MHz/15 MHz) scans.

When the span is below 15 MHz in the baseband and RF band, one physical frame corresponds to one logical frame; this is referred to as Vector mode, and the span in vector mode is called the Vector span. In the other cases, one logical frame is composed of multiple physical frames, and this is called Scalar mode.

Span \leq 15 MHz: Vector mode

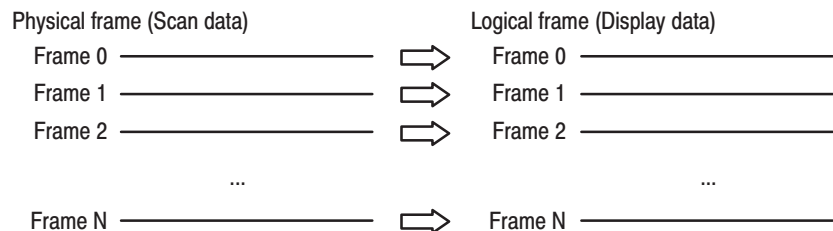

Span > 15 MHz: Scalar mode

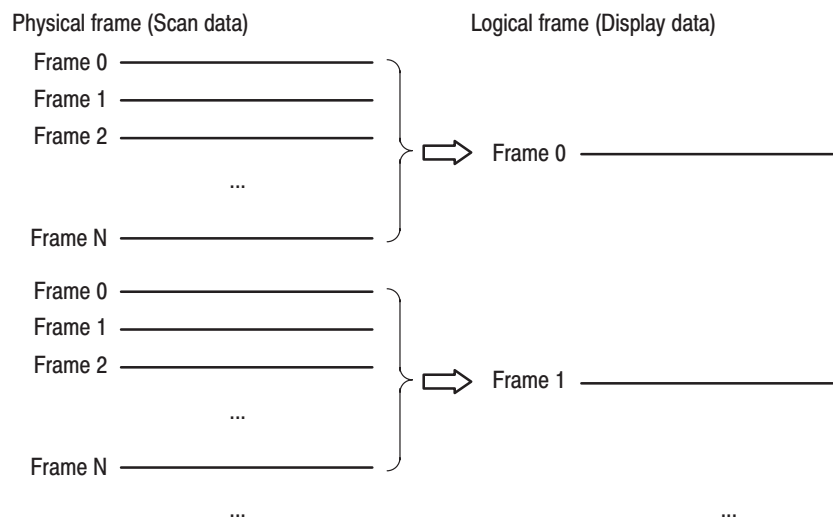
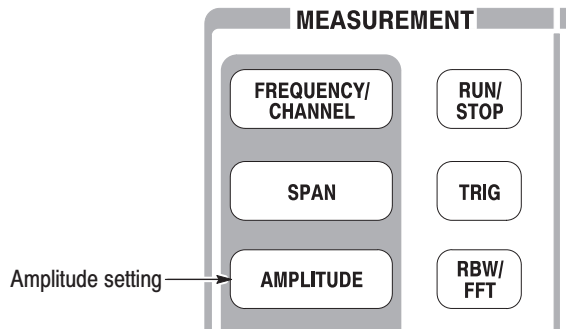

Figure 3–57: Vector mode and scalar mode

Setting Amplitude

This section describes the fundamental amplitude settings for observing spectrum. You can add correction to the waveform display by considering frequency characteristics of external devices such as antennas or preamplifiers.



Basic Procedure

To set amplitude, follow these steps:

1. Press the **AMPLITUDE** key on the front panel.
2. Set the reference level with the **Ref Level** side key.

The reference level indicates the maximum value of the vertical axis (see Figure 3–58). The setting range is listed in Table 3–11.

Table 3–11: Reference level setting range

Frequency band	Setting range
Baseband	–30 to +20 dBm (2 dB step)
RF (WCA230A) / RF1 (WCA280A)	–51 to +30 dBm (1 dB step)
RF2, 3 (WCA280A)	–50 to +30 dBm (1 dB step)

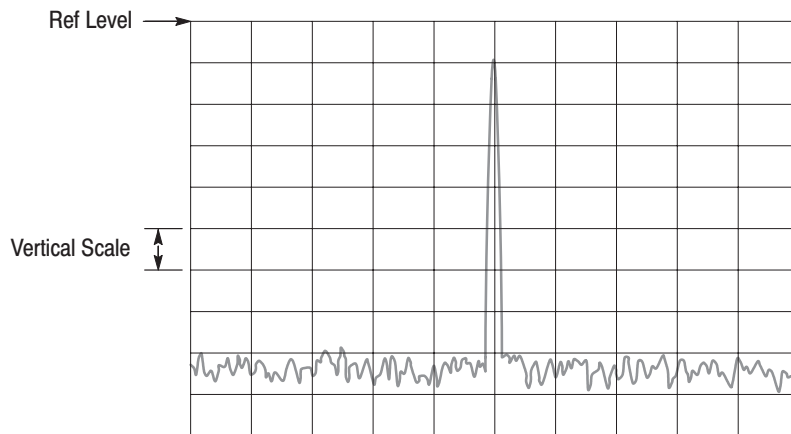

Figure 3-58: Setting the amplitude

3. To best display the waveform automatically, press the **Auto Level** side key.

NOTE. An input signal within 10 MHz of the center frequency may cause Auto Level to choose the wrong reference level, even if the span setting does not make the signal appear on screen. To prevent nonlinear operation, the reference level may need to be adjusted manually.

Auto Level will force the analyzer to acquire new data, which will overwrite the existing data. To scale the existing displayed waveform, do not use Auto Level but use the View: Scale menu.

The RF input signal is reduced by the attenuator and is transformed to the IF signal using the mixer in the down converter (refer to *Architecture* on page 1–6). The attenuation level and the mixer level are normally set automatically. If necessary, you can set them manually as described in step 4.

4. To set the attenuation level or the mixer level manually, use the **RF Atten/Mixer** side key to select **RF Att** or **Mixer**.

NOTE. RF Atten/Mixer is set to Auto by default. In this setting, the mixer level is fixed to –25 dBm.

When you select **RF Att**:

Select the attenuation level with the **RF Att** side key. Refer to Table 3–12. Reducing the attenuation may increase the signal level compared to the noise floor, because the noise is generated after the RF attenuator.

Table 3-12: RF attenuation level setting

Frequency band	Attenuation level (dBm)
RF (WCA230A) RF1 (WCA280A)	0 to 50 (2 dB step)
RF2, 3 (WCA280A)	0, 10, 20, 30, 40, or 50

When you select **Mixer**:

Select the first mixer input level using the **Mixer Level** side key.

Select the level according to your measurement. Normally, you can use the default setting, which is -25 dBm. The level can be increased up to -5 dBm for measurements requiring a wide dynamic range, such as the ACPR (Adjacent Channel Power Ratio) measurement. See Table 3-13.

NOTE. When you increase the mixer level, the distortion also increases.

Table 3-13: Mixer level setting

Frequency band	Mixer level (dBm) ¹
RF (WCA230A) RF1 (WCA280A)	-5 , -10 , -15 , -20 , or -25
RF2, 3 (WCA280A)	-5 , -15 , or -25

¹ -25 dBm fixed when RF Atten/Mixer is set to Auto.

5. *S/A mode (except Real Time) only.* The vertical scale is set to 10 dB/div (10 dB per division) by default. If you want to change the setting, use the the **Vertical Scale** side key and select the unit using the **Vertical Units** side key. The settings are listed in Table 3-14.

Table 3-14: Vertical units and scale setting

Vertical units	Vertical scale (/div) ¹
dBm, dB μ V	1 to 10
V	200 n to 20 m
W	100 p to 100 μ

¹ **1-2-5 sequence with the general purpose knob.**
Arbitrary value with the numeric keypad.

6. When you apply amplitude correction, press the **Corrections...** side key to set the parameters. Refer to *Amplitude Correction* on page 3-91 for details.

Over-Voltage Input

Set the reference level (Ref Level) according to the input signal level. The default setting is 0 dBm. If the signal level gets too high or the reference level is set too low, over-voltage input may occur. If an over-voltage input occurs, the status indicator “A/D OVERFLOW” is displayed in the red box (see Figure 3–59).



CAUTION. If a signal exceeding +30 dBm (1 W) is applied, it can damage the analyzer. Be sure to limit input signals to +30 dBm or below.

When the input signal level is too high, A/D OVERFLOW is indicated in the red box.

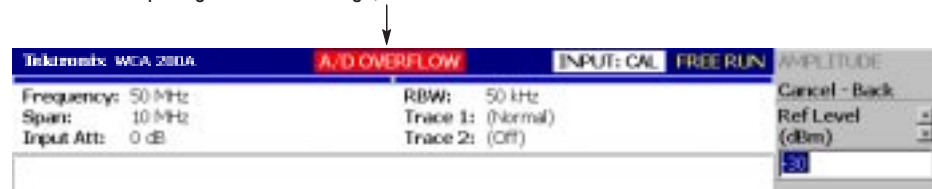

Figure 3–59: A/D overflow indicator

NOTE. If “A/D OVERFLOW” is displayed, it indicates that the A/D converter in the subsequent part of the down converter inside this instrument is overloaded. In this case, data display is distorted and the measurement is not accurate.

If a signal larger than the reference level set value by 20 dB or more is applied continuously, however, the limiter of the IF amplifier in the down converter is automatically activated to prevent large level signals from passing through the A/D converter into the subsequent part. Even if a signal exceeding the reference level is applied, therefore, “A/D OVERFLOW” may not be displayed. Auto Leveling the signal can usually eliminate all overload conditions.

Take sufficient care about the input signal level.

The overflow indicator is updated at every physical frame acquisition. When a high level signal is applied under a setting that uses multiple physical frames for one scan, “A/D OVERFLOW” may be displayed for a moment and then turned off immediately. When a single high-level single signal is input under a setting using one physical frame in one scan, the same phenomenon may be observed.

Amplitude Correction

If an external device such as an antenna or preamplifier is connected to the analyzer, you can amplitude correct the waveform by considering the amplitude characteristics of the external device.

NOTE. The amplitude correction function is fully controlled only in the S/A mode (except real-time mode). In the other modes (Real Time S/A, Demod, and Time), amplitude offset control is available. Refer to page 3–97 for setting the offset.

Figure 3–60 shows the concept of amplitude correction. In this example, a signal with -80 dBm is sent to a preamplifier with a gain of $+20$ dB around 1 GHz. In the normal display, without any amplitude correction, the signal peak becomes $-80 + 20 = -60$ dBm. If amplitude correction is performed, the peak becomes $-60 - 20 = -80$ dBm to obtain the original peak value of the input signal.

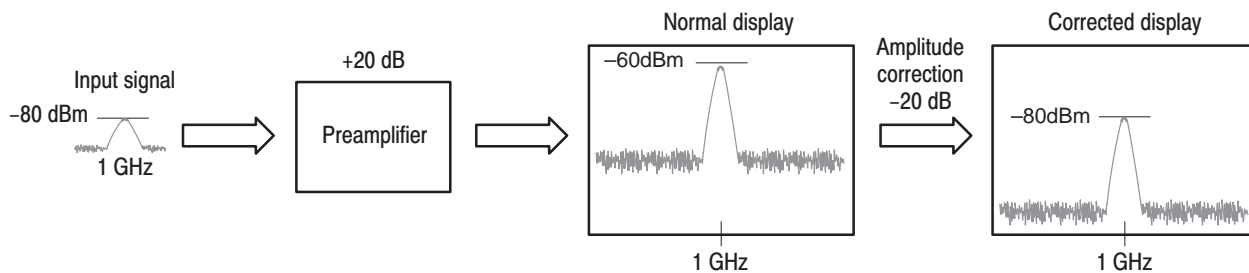

Figure 3–60: Concept of the amplitude correction

Amplitude Correction File

Before performing amplitude correction, you must describe the frequency characteristics of the external device in an amplitude correction file (*.cor).

You can use word processing software to create the file on a computer and then use a disk or network to load the file into the analyzer. Alternatively, you can create correction data on the analyzer screen.

The rules for creating an amplitude correction file are given on page 3–93 and the procedures are given on page 3–94.

File Format. A correction file contains amplitude correction values at each frequency, in the following format:

```
<Frequency 1> = <Amplitude correction value 1>
<Frequency 2> = <Amplitude correction value 2>
<Frequency 3> = <Amplitude correction value 3>
...
```

Example: The following amplitude correction file has correction data for three points:

Correction data:	Correction file description:
10 dB at 10 MHz	10M=10
5 dB at 100 MHz	100M=5
0 dB at 1 GHz	1G=0

In this example, only the data from 10MHz to 1GHz is corrected (see Figure 3–61). The correction value in the display range is obtained using linear interpolation between input points. A waveform obtained by subtracting the correction value from the input waveform is displayed.

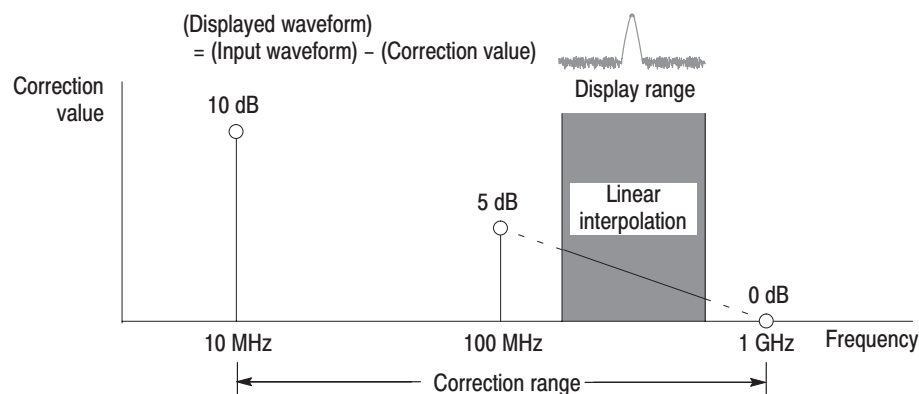

Figure 3-61: Amplitude correction example

Linear or Logarithmic (Log/dB) interpolation can be selected using the following menus:

■ **AMPLITUDE** → **Corrections...** → **Interpolation...** → **Freq Interpolation**

Lin. Linear interpolation of correction values is performed on the frequency axis using a linear scale.

Log. Linear interpolation of correction values is performed on the frequency axis using a logarithmic scale.

■ **AMPLITUDE** → **Corrections...** → **Interpolation...** → **Ampl Interpolation**

Lin. Linear interpolation of correction values is performed on the amplitude axis using a linear scale.

dB. Linear interpolation of correction values is performed on the amplitude axis using a logarithmic scale.

Rules for Creating an Amplitude Correction File.

- Create the file as a text file and save it with the extension “.cor”.
- The maximum number of input lines is 3000.
- The order of correction data input is free because the file is sorted when it loads. However, it may be easier to follow if you enter data in the order of ascending frequency.
- Numeric values are described without the unit of frequency and amplitude (Hz, dB, W, etc.). For example, frequency 5 MHz is expressed as 5M.
- Frequency can be expressed as a floating point number or with the SI unit (k, M, or G). For example, each of the following lines shows three different ways to express the same value:

```
1000, 1E+3, 1k
1230000, 1.23E+6, 1.23M
1000000000, 1.0E+9, 1.0G
```

- Amplitude is expressed as a decimal number or integer (such as 1.23 or 10).
- Do not use a space in a numeric value; however, you can space before and after “=”.

Correct: 10M = 10 (A space is inserted before and after “=”.)

Incorrect: 10 M=10 (A space is inserted between “10” and “M”.)

Creating an Amplitude Correction File on a Computer. Use word processing software on a computer to create a text file with the extension “.cor”.

Be sure to use the correct file format (refer to *File Format* on page 3–61) and follow the *Rules for Creating an Amplitude Correction File* on page 3–93.

For information about performing amplitude correction, refer to page 3–98.

Creating Correction Data on the Analyzer Screen. The procedure for entering new correction data or modifying existing data on the screen is as follows. Refer also to *Rules for Creating an Amplitude Correction File* on page 3–93.

1. Press the **AMPLITUDE** key on the front panel.
2. Press the **Corrections...** side key.
3. *To edit an existing file:* Refer to page 3–153 for file handling.
 - a. Press the **Load Table** side key to load the file.
 - b. Press the **Edit Table...** side key.
4. *To enter new data:* See Figure 3–62.
 - a. Press the **Frequency** side key and enter the frequency of a correction point.
 - b. Press the **Amplitude** side key and enter the amplitude correction value at the correction point.
 - c. Press the **Add New Point** side key.

A new row is added, containing the same frequency and amplitude correction values as the previous row. Modify the values appropriately.

NOTE. *If you set the same frequency as the previous row, the amplitude correction value will be overwritten to the previous row the next time you press the Add New Point side key.*

It is not necessary to enter correction data in order by frequency. The rows are automatically reordered in ascending order of frequency.

- d. Repeat step c to enter the frequency and amplitude correction values for all points.
- e. Press the **Done Editing Table** side key.

The input is accepted and a new row is added.

5. To add correction data:
 - a. Press the **Select Point To Edit** side key and turn the general purpose knob to move the cursor to the last row (empty) in the table.
 - b. Perform step 4 to enter the frequency and amplitude correction values.

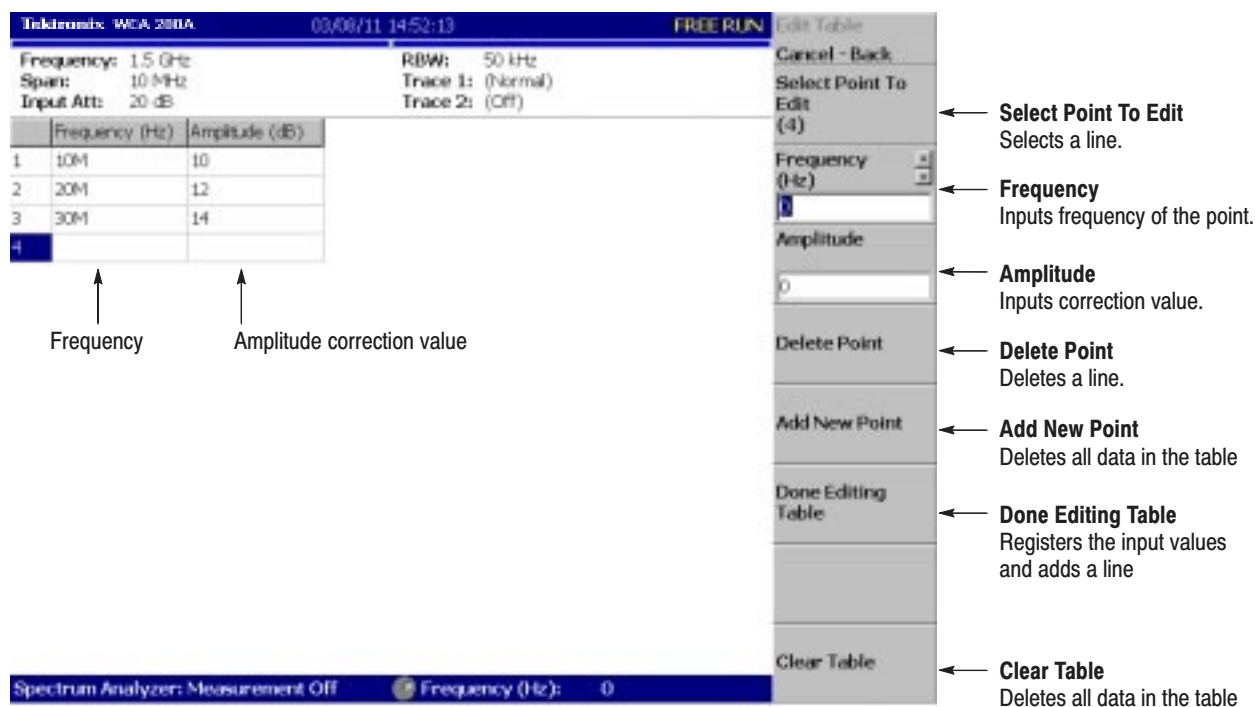

Figure 3-62: Amplitude correction data input

6. To modify input data, press the **Select Point To Edit** side key and turn the general purpose knob to move the cursor to the row to be modified. Use the following side keys as needed:
 - To modify a frequency, use the **Frequency** side key.
 - To modify an amplitude, use the **Amplitude** side key.
 - To delete a row, press the **Delete Point** side key.
 - To delete all data in the table, press the **Clear Table** side key.
7. Repeat steps 5 through 6 as needed.

- 8.** When you have finished the data input, save the file if necessary.
 - a.** Press the **AMPLITUDE** key on the front panel.
 - b.** Press the **Corrections...** side key.
 - c.** Press the **Save Table** side key to specify the save file.
Refer to page 3–153 for file handling.

For information about performing amplitude correction, refer to page 3–98.

Setting the Offset

The amplitude correction function includes amplitude and frequency offset.

NOTE. The amplitude offset is available in all the measurement modes of S/A, Demod, and Time.

Amplitude Offset. Subtracts the specified offset from the original amplitude (see Figure 3–63). The offset value is set using the menu item **AMPLITUDE** → **Corrections...** → **Amplitude Offset**.

The operation varies slightly between the measurement modes as follows:

- *In the S/A mode (except real-time mode):* The amplitude offset is effective whenever the amplitude correction is turned on (**AMPLITUDE** → **Corrections...** → **Amplitude Table** → **On**) even if the table is not set.
- *In the other modes (Real Time S/A, Demod, and Time):* The amplitude offset is always effective. The default value is zero. If you set the offset to a non-zero value, a waveform shifts vertically as shown in Figure 3–63.

(Amplitude of a displayed waveform)
= (Amplitude of an acquired waveform) - (Amplitude offset value)

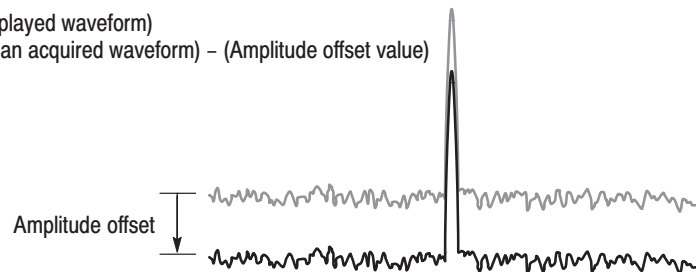

Figure 3–63: Amplitude offset

Frequency Offset. Shifts the correction range by the specified offset with the same correction table (see Figure 3–64). The offset value is set using the menu item **AMPLITUDE** → **Corrections...** → **Frequency Offset**.

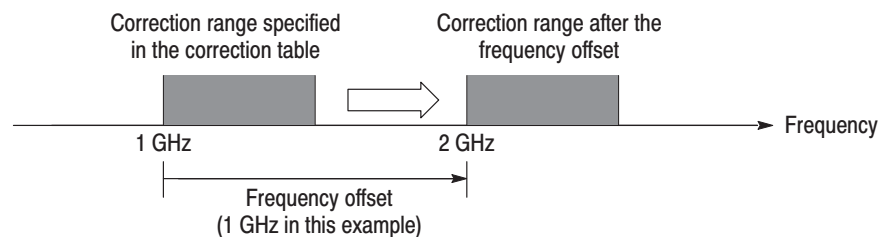

Figure 3–64: Frequency offset

Performing Amplitude Correction

Load an amplitude correction file and acquire input signals:

1. Press the **AMPLITUDE** key on the front panel.
2. Press the **Corrections...** side key.
3. Do either of these two steps:
 - Press the **Edit Table...** side key to create an amplitude correction file. Refer to page 3–92 for creating the correction file.
 - Press the **Load Table** side key to specify an amplitude correction file. Refer to page 3–153 for file operation.
4. If necessary, press the **Amplitude Offset** side key to set the amplitude offset.
5. If necessary, press the **Frequency Offset** side key to set the frequency offset.
6. Press the **Interpolation...** side key to select scaling for the interpolation:
 - a. Press the **Freq Interpolation** side key to select the scale for frequency interpolation: Lin (linear) or Log (logarithmic).
 - b. Press the **Ampl Interpolation** side key to select the scale for amplitude interpolation: Lin (linear) or dB (logarithmic).
7. Press the **Amplitude Table** side key to select **On**. The amplitude correction is now applied to the waveform.

The amplitude correction is applied to the acquired data and the corrected waveform is shown. When the amplitude correction is turned on, “Correction” is displayed in the setup display area at the upper right of the screen, as shown in Figure 3–65.

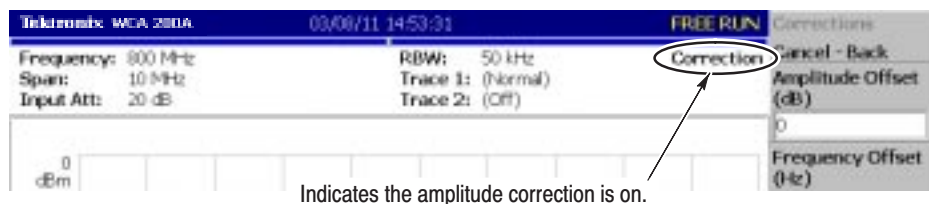

Figure 3–65: Amplitude correction setup display

Erasing Correction Data

The analyzer automatically saves the correction data in use when it is powered down. The data will be erased when you press these keys:

- **AMPLITUDE** → **Corrections...** → **Edit Table...** → **Clear Table**
- **PRESET**

Selecting Input Source

You can select from three input sources in the Input menu: RF, IQ, and Cal.

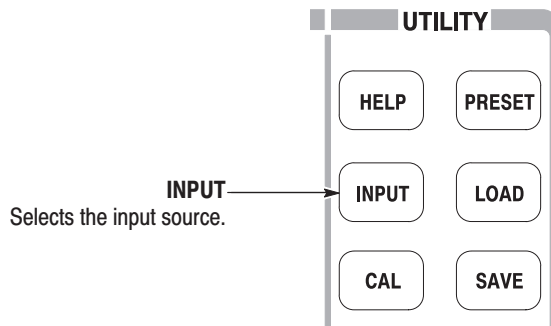

Press **INPUT** → **Signal Input Port...** and then select one of the following:

- **RF.** *Default.* Selects the RF connector on the front panel as the input source. See Figure 2–1 on page 2–1 for the front panel connectors.
- **IQ.** *Option 03 only.* Selects the baseband I and Q connectors on the rear panel as the input source. See Figure 2–2 on page 2–2 for the rear panel connectors.
- **Cal.** Uses the internal 50 MHz calibration signal as the signal source. Refer to *Functional Check* on page 1–14 for using the cal signal to check the system performance.

NOTE. *IQ INPUT (Option 03 only). The IQ input gain of the analyzer is set in 10 dB steps. To maximize the dynamic range, you may need to adjust the signal level externally, or insert attenuators in the I and Q signal paths.*

When you calibrate the IQ offset, set the IQ input signal level to zero externally. (The IQ offset calibration is included in the center offset calibration. Refer to Center Offset Calibration on page 1–23.)

FFT and RBW

The input signal is converted to the frequency domain spectrum by FFT (Fast Fourier Transform) processing. RBW (Resolution Bandwidth) processing is then applied, for compatibility with measurement data from conventional swept spectrum analyzers (see Figure 3–66).

NOTE. You can set the FFT and RBW parameters in the S/A (spectrum analysis) mode except real-time. In the other modes (Real Time S/A, Demod, and Time), the number of FFT points is always 1024 and the window is always Blackman-Harris 4B type.

The two adjustable parameters for FFT are:

- FFT points
- FFT window

The three adjustable parameters for RBW are:

- Resolution bandwidth (RBW)
- Filter shape
- Roll-off ratio (for the Nyquist or Root Nyquist filter)

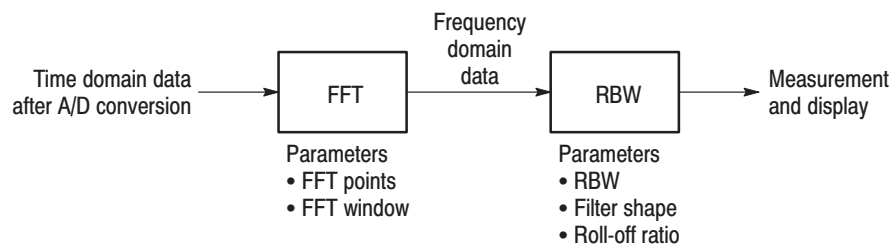

* FFT points is normally set automatically with the RBW setting.
RBW is normally set automatically with the span setting.

Figure 3–66: FFT and RBW process

Setting RBW/FFT Parameters

RBW is normally set automatically with the span setting, and the filter is Gaussian by default. The number of FFT points is normally set automatically with the RBW setting, and the window is Blackman-Harris 4B by default.

To modify the RBW/FFT parameters, follow these steps:

1. Press the **RBW/FFT** key on the front panel.
2. To set the RBW parameters manually, do the following steps:
 - a. Press the **RBW/FFT** side key to select **Man** (Manual).
 - b. Press the **RBW** side key and set the resolution bandwidth.
 - c. Press the **RBW Filter Shape...** side key and select a filter: Rect (rectangular), Gaussian, Nyquist, or Root Nyquist
 - d. When you select Nyquist or Root Nyquist filter, press the **Rolloff Ratio** side key and set the value for the filter. Range: 0 to 1 (default: 0.5)
3. To change the FFT parameters, do the following steps:
 - a. Press the **RBW/FFT** side key to select **FFT**.

The waveform without RBW processing is displayed on the screen (see Figure 3–67).

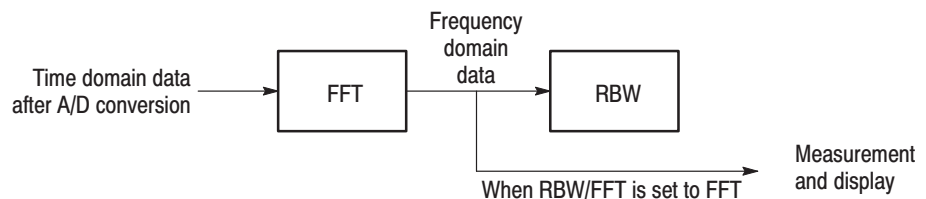

Figure 3–67: Process flow when RBW/FFT = FFT

- b. Press the **FFT Points** side key and select the value using the general purpose knob.
Range: 64 to 8192 with step of 2^n .
Example: 64, 128, 256, ...8192.
- c. Press the **FFT Window...** side key and select the window.
- d. When RBW processing is necessary, press the **RBW/FFT** side key again to select **Auto** or **Man**.

When you select Auto or Man, the value of FFT Points set in step 3b is modified to the optimum value for the RBW setting.

FFT Points

The number of FFT points is normally set with RBW setting automatically. The value is basically 1024. It can be set in powers of 2 from 64 to 8192. This value is the number of the points in one physical frame in the time and frequency domains. If the number of the points is reduced, the frame period is shortened and more spectrum variations can be observed in the spectrogram view. If the number of the points is increased, S/N ratio and frequency resolution are improved.

Limit on the FFT Points

The number of FFT points is normally limited to 8192 internally to avoid displaying internally-generated spurious signals (see NOTE). However, you can remove this restriction and set the number of FFT points up to 65536 using the following steps:

NOTE. *Setting the number of FFT points greater than the limit (8192) causes the noise floor to go down and occasionally causes spurious signals to appear (see Figure 3–68). It cannot be determined whether the spurious signal comes from the input signal or the instrument.*

1. Display the measurement signal on the screen.
2. Press the **RBW/FFT** key on the front panel.
3. Press the **RBW/FFT** side key to select **FFT**.
4. Press the **Extended Res.** side key to select **On**.
5. Press the **FFT Points** side key and select the value with the general purpose knob. The range extends up to 65536 in powers of 2.

The waveform after FFT is displayed with the selected number of points.

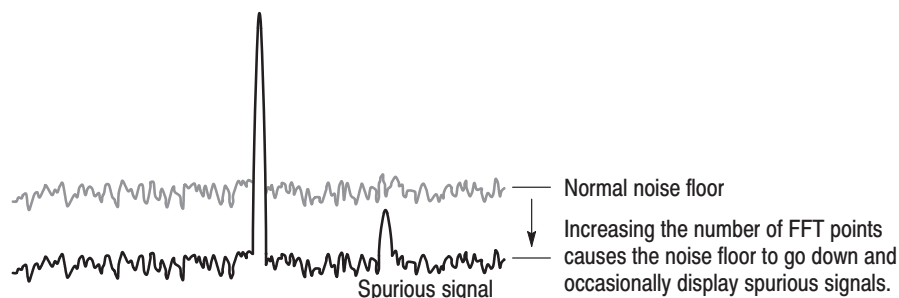

Figure 3–68: Generating spurious signals by increasing the number of FFT points

FFT Window

The phase of the waveform processed by FFT analysis is assumed to start at zero and end at zero, so the waveform data is an exact multiple of one cycle. If the phase at the start and end of the waveform are equal, there is no unnatural discontinuity in the signal waveform, and the frequency and the amplitude can be accurately calculated.

If the waveform data is not an exact multiple of one cycle, the amplitudes at the start and end of the waveform will be different. There will be a discontinuity of the waveform between the beginning and end, and a high-frequency transient phenomenon occurs. When this happens, inaccurate frequency information is recorded in the frequency domain.

If a window function is applied to the waveform, the start and end amplitudes will be closer, and the discontinuity is reduced. The frequency components that are calculated from the signal by FFT also become more accurate. Choose the FFT window according to your objective: accurate measurement of the frequency or accurate measurement of the amplitude of the frequency components.

Window Characteristics

In FFT windows, the frequency resolution is inversely proportional to the amplitude accuracy. Select a proper window according to the measurement items and characteristics of the signal source. Table 3–15 shows characteristics and usages of major windows.

Table 3–15: Characteristics and usage of FFT windows

FFT window	Characteristics	Usage
Rectangular	<ul style="list-style-type: none"> ■ Suitable for frequency measurement but not suitable for amplitude measurement. ■ Same result as measurement without a window. 	<ul style="list-style-type: none"> ■ Transient phenomenon or burst; signal levels before and after the event are roughly same. ■ Sinusoidal wave with little amplitude variation and stable frequency. ■ Wide bandwidth irregular noise; spectrum changes slowly.
Hamming, Hanning	<ul style="list-style-type: none"> ■ Suitable for frequency measurement. ■ Inferior in accuracy of amplitude to the rectangular window. ■ Frequency resolution of Hamming is slightly superior to that of Hanning. 	<ul style="list-style-type: none"> ■ Sinusoidal wave. ■ Repeating narrow bandwidth irregular noise. ■ Transient phenomenon or burst; signal levels before and after the event are remarkably different.
Blackman-Harris	<ul style="list-style-type: none"> ■ Suitable for amplitude measurement but not suitable for frequency measurement. 	<ul style="list-style-type: none"> ■ Signal that has one-frequency ruling when a high order harmonic is detected.

Figure 3–69 outlines how frequency domain data is generated from time domain data. The FFT window serves as a bandpass filter between time and frequency domain data. The FFT frequency resolution and amplitude accuracy of each frequency component depends on the window shape.

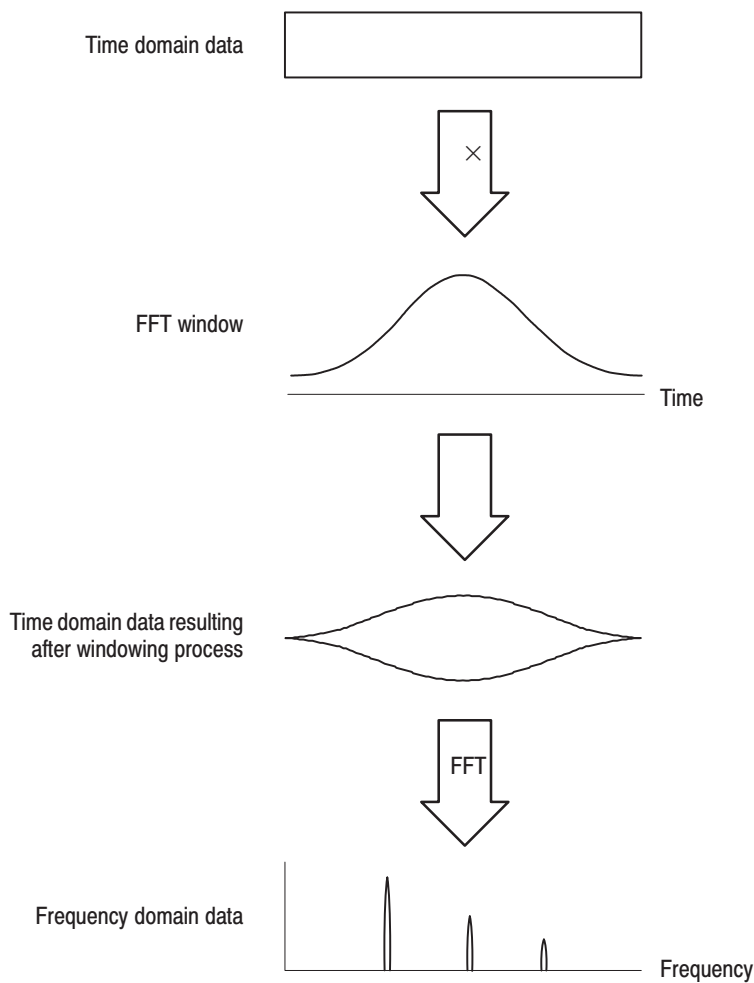

Figure 3–69: Windowing process of time domain data

Generally, window frequency resolution is inversely proportional to the accuracy of measuring amplitude levels. For ordinal measurements, select the window capable of separating the desired frequency component. Such a window maximizes the accuracy of measuring amplitude levels and minimizes leakage error while separating each frequency component.

To select a proper window, first select the rectangular window, then sequentially switch to a window with less frequency resolution, such as Hamming, Hanning, or Blackman-Harris. Use the last window that still passes the frequency component to be separated. Suitable frequency resolution and amplitude accuracy are obtained by using the window immediately before the one from which the frequency component cannot be separated.

Consider the following characteristics when selecting a window for your purpose:

- Frequency resolution is improved by reducing the width of the main lobe window.
- Accuracy of the amplitude levels of frequency components is improved by reducing side lobe level relative to the main lobe.

Window Type The analyzer supports a total of 15 windows, including the major windows mentioned previously (refer to Table 3–16).

Table 3–16: FFT window and bandpass filter

Window	Bandpass filter	-3 dB bandwidth	Maximum side lobe	Equivalent noise bandwidth
Blackman-Harris 3 sample A type		1.53	-62 dB	1.61075
Blackman-Harris 3 sample B type		1.622	-71 dB	1.708538
Blackman-Harris 4 sample A type		1.698	-76 dB	1.793948
Blackman-Harris 4 sample B type (Default)		1.898	-92 dB	2.004353

Table 3-16: FFT window and bandpass filter (Cont.)

Window	Bandpass filter	-3 dB bandwidth	Maximum side lobe	Equivalent noise bandwidth
Blackman		1.642	-58 dB	1.726757
Hamming		1.302	-43 dB	1.362826
Hanning		1.438	-32 dB	1.5
Parzen		1.27	-27 dB	1.330747
Rosenfield		1.814	-48 dB	1.90989
Welch		1.15	-21 dB	1.197677
Sine Lobe		1.186	-23 dB	1.233702

Table 3-16: FFT window and bandpass filter (Cont.)

Window	Bandpass filter	-3 dB bandwidth	Maximum side lobe	Equivalent noise bandwidth
Sine Cubed		1.654	-39 dB	1.734891
Sine to the 4 th		1.85	-47 dB	1.944444
Flat Top		3.182	-51 dB	3.196927
Rectangular		0.886	-13 dB	1

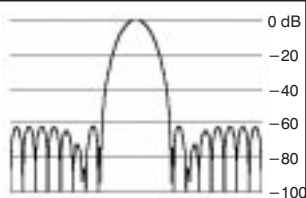
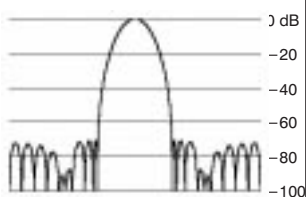
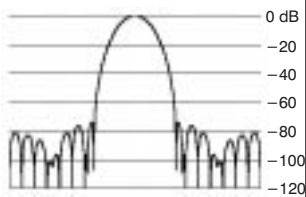
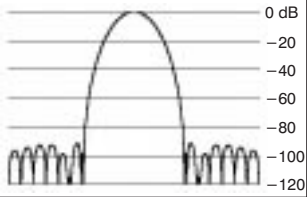
Acquiring Data

There are several modes in which you can acquire data:

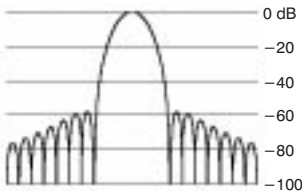
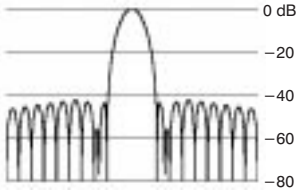
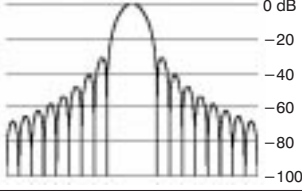
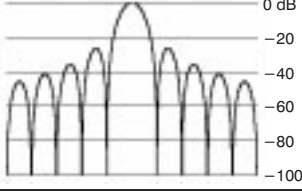
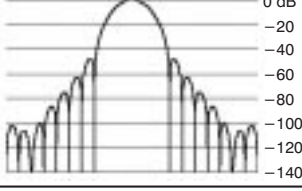
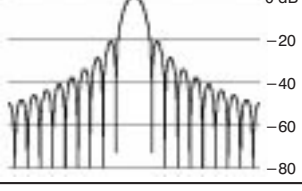
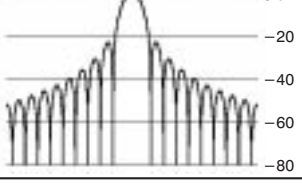
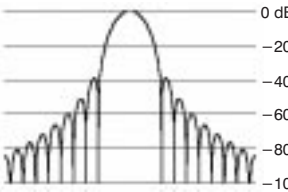
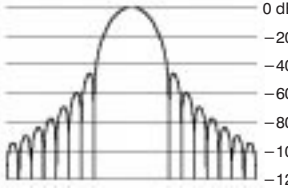
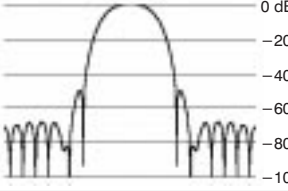
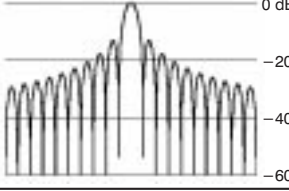
- Free run mode to acquire data without triggering
- Triggered mode to acquire data every trigger event
- Continuous mode to repeat acquisition
- Single mode to acquire one waveform

When the measurement mode is real-time spectrum analysis (Real Time S/A), modulation or time analysis (Demod or Time), you must set time parameters such as acquisition length and analysis length.

This section covers the following topics:

- Starting/Stopping Data Acquisition
- Seamless Acquisition
- Time Parameters

Starting/Stopping Data Acquisition

Use the **RUN/STOP** key on the front panel to start or stop data acquisition. Table 3–17 summarizes how to acquire the waveform. You can set the trigger mode to acquire data with or without triggering.

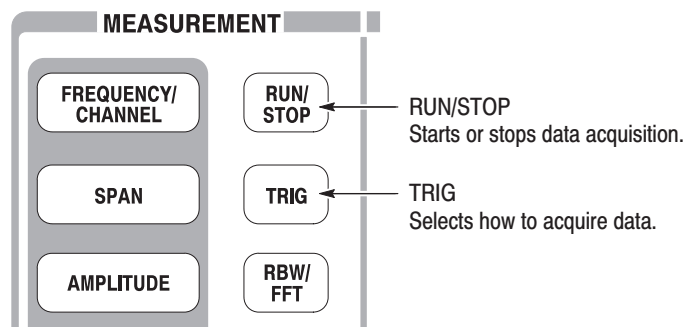

To set the trigger mode, select **TRIG** → **Mode...** as follows:

- **Free run mode:** Acquires the waveform without triggering.
- **Triggered mode:** Acquires the waveform with triggering.

To select continuous or single acquisition, select **TRIG** → **Repeat...** as follows:

- **Continuous mode:** Acquires waveforms repeatedly.
- **Single mode:** Acquires one waveform.

Table 3-17: How to acquire a waveform

Trigger mode (TRIG → Mode)	Repeat mode (TRIG → Repeat)	Description
Free run	Continuous	Press RUN/STOP to acquire data repeatedly. Press this key again to stop acquisition.
	Single	Press RUN/STOP to acquire one waveform.
Triggered	Continuous	Press RUN/STOP to acquire data every trigger event.
	Single	Press RUN/STOP to acquire one waveform every trigger event.

Stop and Show Results

Instead of the **RUN/STOP** key, you can stop data acquisition by pressing the **Stop and Show Results** side key in the Trig menu when the measurement mode is Real Time S/A, Demod, or Time. However, there is the following difference in function:

- Pressing the **RUN/STOP** key to stop data acquisition: The block data acquired at the moment of pressing the key is discarded and the measurement results are shown for the previous block of data.
- Pressing **TRIG** → **Stop and Show Results** to stop data acquisition: Shows measurement results even for the block of data acquired at the moment of pressing the side key, which might not fill a whole block.

In either case, press **RUN/STOP** again to restart acquisition.

Seamless Acquisition

The frame data is acquired every designated time. The interval between one acquisition and another is called a “frame cycle,” as shown in Figure 3–70.

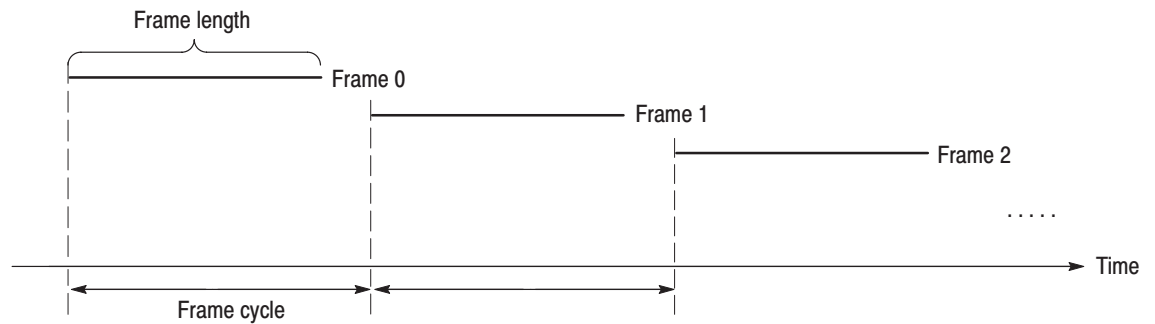

Figure 3–70: Frame cycle

If the frame cycle is longer than the frame length, time gaps appear between frames. The shorter the frame cycle, the more precisely you can observe the spectrum waveform variation in time. You can acquire frames without gaps when the span setting is below 15 MHz. Acquiring frame data without a gap is called Seamless Acquisition. See Figure 3–71.

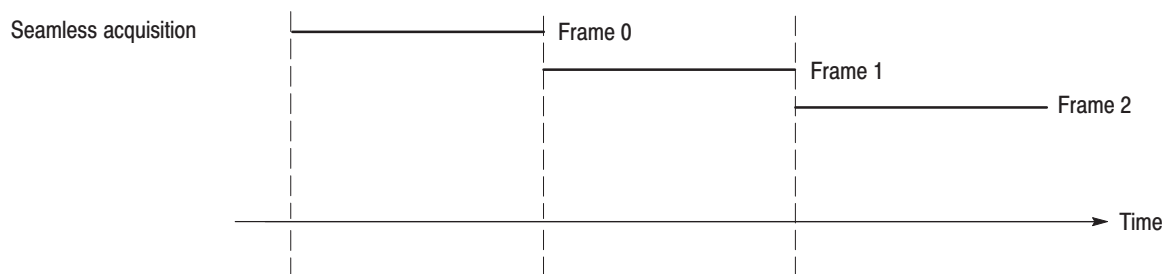

Figure 3–71: Seamless acquisition

When the span is set greater than 15 MHz, one display frame is reproduced from multiple acquired frames and the frame cycle becomes meaningless. Refer to *Vector Span* on page 3–85 for details.

Time Parameters (*Real Time S/A, Demod, and Time Modes Only*)

In Real Time S/A, Demod, and Time modes, you must set timing the parameters described below (see Figure 3–72). For procedures to set these parameters, refer to *Setting Analysis Range for the Main View* on page 3–29 and *Setting FFT Processing Range for the Subview* on page 3–31.

Time Parameters in Real Time S/A Mode

The Timing menu in the Real Time S/A (real-time spectrum analysis) mode contains the following items:

Acquisition Length. Sets the time length to acquire one block (= M frames). The acquisition length is calculated using this equation:

$$(\text{One block acquisition length}) = M \times (\text{One frame acquisition length})$$

where M is the number of frames in a block.

One frame acquisition length is determined by span internally. For details, refer to Table A–10 on page A–8 in *Appendix A: Specifications*.

Spectrum Offset. Specifies the number of the frame in the spectrogram to display the spectrum. The latest frame is number zero. Older frames have larger negative numbers.

Time Parameters in Demod and Time Modes

The Timing menu in Demod (modulation analysis) and Time (time analysis) modes contains the following items:

Acquisition Length. Same as above in the Real Time S/A mode.

Acquisition History. Specifies the number of the block to display and analyze. The latest block is number zero. Older blocks have larger negative numbers. In most cases the analyzer retains previous acquisitions. You can view previous acquisitions by selecting the acquisition history by block number.

Spectrum Length. Displays the time length for FFT processing of the spectrum displayed in the subview. It is equivalent to one frame acquisition length determined by Span/RBW/FFT points setting.

Spectrum Offset. Sets the beginning of Spectrum Length with respect to the trigger output point.

Analysis Length. Sets the time length of the analysis range in the block specified with Acquisition History.

Analysis Offset. Sets the beginning of Analysis Length with respect to the trigger output point.

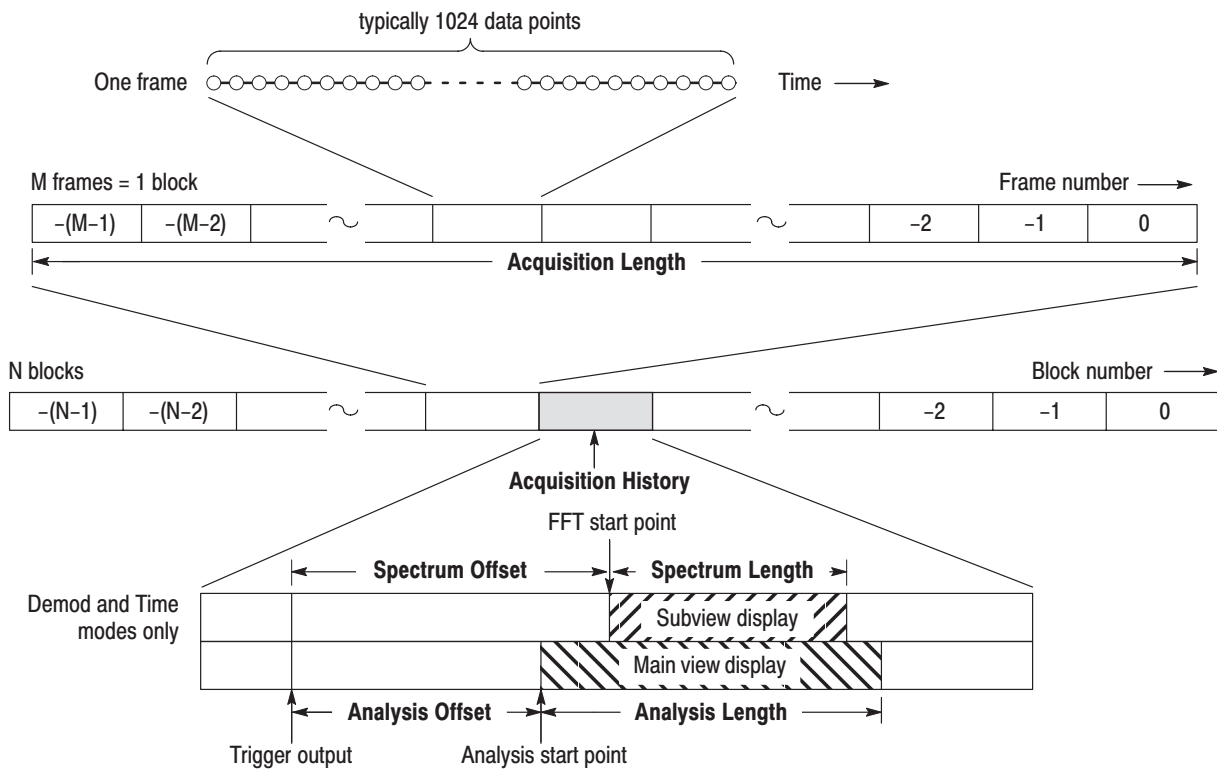
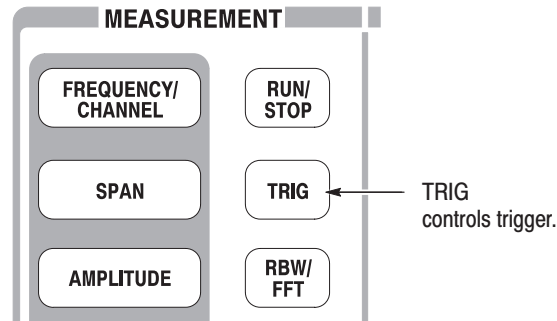

Figure 3-72: Timing parameters

Trigger

Trigger determines when to stop data acquisition and display measurement results. Use the Trig menu to set trigger.



This section describes the following trigger parameters:

- **Mode:** Selects free run or triggered acquisition.
- **Repeat:** Determines whether to acquire data continuously or singly.
- **Source:** Selects a trigger signal source.
- **Level:** Sets a trigger level.
- **Slope:** Selects the rising or falling edge of a trigger signal.
- **Position:** Specifies a trigger position.

You must create a trigger mask when triggering in the frequency domain with Option 02. Refer to page 3–123 for creating a trigger mask.

A “T” mark (with “O” optionally) indicating a trigger point is displayed on the overview in the Demod and Time modes. Refer to page 3–130 for information about displaying the trigger point.

Setting Trigger

Use the Trig menu to set up a trigger. Press the **TRIG** key on the front panel and set the parameters using the following menu items.

NOTE. *Except for the Repeat menu item, the trigger menu is available any time the measurement mode (Mode) is set to real-time spectrum analysis (Real Time S/A), modulation analysis (Demod), or time analysis (Time).*

Trigger Mode

Press the **Mode...** side key to select a trigger mode.

The trigger mode determines whether to acquire data with or without triggering. The concept is illustrated in Figure 3-75 on page 3-119.

Free Run. Acquires and displays waveform without triggering. Press the **RUN/STOP** key to start data acquisition. To stop the acquisition, press the **RUN/STOP** key again.

Triggered. Set the trigger conditions (level, slope, and position) before starting data acquisition by pressing the **RUN/STOP** key. When the trigger occurs, data is acquired and displayed. To force data acquisition to stop when the trigger does not occur, press the **RUN/STOP** key again.

Repeat Mode

Press the **Repeat...** side key to select a repeat mode.

Continuous. Acquires and displays waveforms repeatedly. Acquisition data will be overwritten while waiting for a new trigger event. Use the Single setting if you need to examine or reanalyze the measurement results. The concept is illustrated in Figure 3-75 on page 3-119.

Single. Acquires and displays one waveform.

Trigger Source The trigger source setting is available when the trigger mode is Normal. Press the **Source** side key to select the trigger source as follows.

Level (Full BW). *Default.* Uses the internal IF (intermediate frequency) signal of the analyzer as the trigger source. The Trigger Level and Position can be set. Refer to page 3–120 for information about the IF trigger.

Power (Span BW). *Option 02 only.* Uses the input signal as the trigger source in the time domain.

Freq Mask. *Option 02 only.* Uses a trigger mask as the trigger source. Refer to page 3–123 for information about creating the trigger mask.

External. Uses the external signal input from the TRIG IN connector on the rear panel as the trigger source. The Trigger Slope and Position can be set. For the specification of the external trigger, refer to page A–12.

Trigger Level The trigger level setting is available when the trigger mode is Triggered and the source is Level or Power. Press the **Level** side key to set the threshold value. Table 3–18 shows the setting range.

Table 3–18: Trigger level setting range

Trigger source	Trigger level
Level (Full BW)	1 to 100% in 1% step (100% means full scale of the internal A/D output)
Power (Span BW)	-40 to 0 dBfs in 1 dBfs step (in time domain, option 02 only)

For the external trigger, the trigger level is fixed internally. For specifications of the external trigger, refer to page A–12.

Trigger Slope

The trigger slope setting is available when the trigger mode is Triggered. Press the **Slope** side key to make a selection. The following selections are available (see Figure 3–73):

Rise. The trigger occurs at the rising edge of the trigger signal.

Fall. The trigger occurs at the falling edge of the trigger signal.

Rise and Fall. The trigger occurs at the rising edge of the trigger signal to acquire the first block, and at the falling edge to acquire the next block. The rising and falling edges alternate at each block acquisition.

Fall and Rise. The trigger occurs at the falling edge of the trigger signal to acquire the first block, and at the rising edge to acquire the next block. The rising and falling edges alternate at each block acquisition.

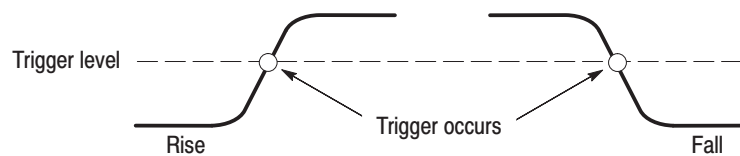

Figure 3–73: Trigger level and slope

Using a Trigger Mask (Option 02). When the trigger source is Freq Mask and you use the trigger mask, the following selection items are available:

In. The trigger occurs when an input signal exits the blue area of a trigger mask and enters the black area.

Out. The trigger occurs when an input signal exits the black area and enters the blue area of a trigger mask.

In and Out. The analyzer triggers with In to acquire the first block, and Out to acquire the second. In and Out alternate at each block acquisition. Use the acquisition history control to view alternate In/Out blocks.

Out and In. The analyzer triggers with Out to acquire the first block, and In to acquire the second. In and Out alternate at each block acquisition. Use the acquisition history control to view alternate In/Out blocks.

Trigger Position Set the trigger position using the Position side key when the trigger mode is Triggered. The trigger position is the position of the trigger represented as a percentage of one block. For example, if you set the trigger position to 50%, the trigger occurs at the center of the block, as shown in Figure 3–74.

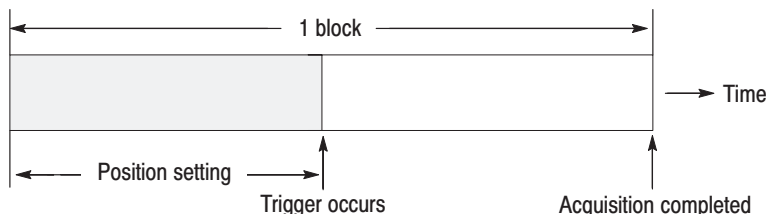

Figure 3–74: Trigger position

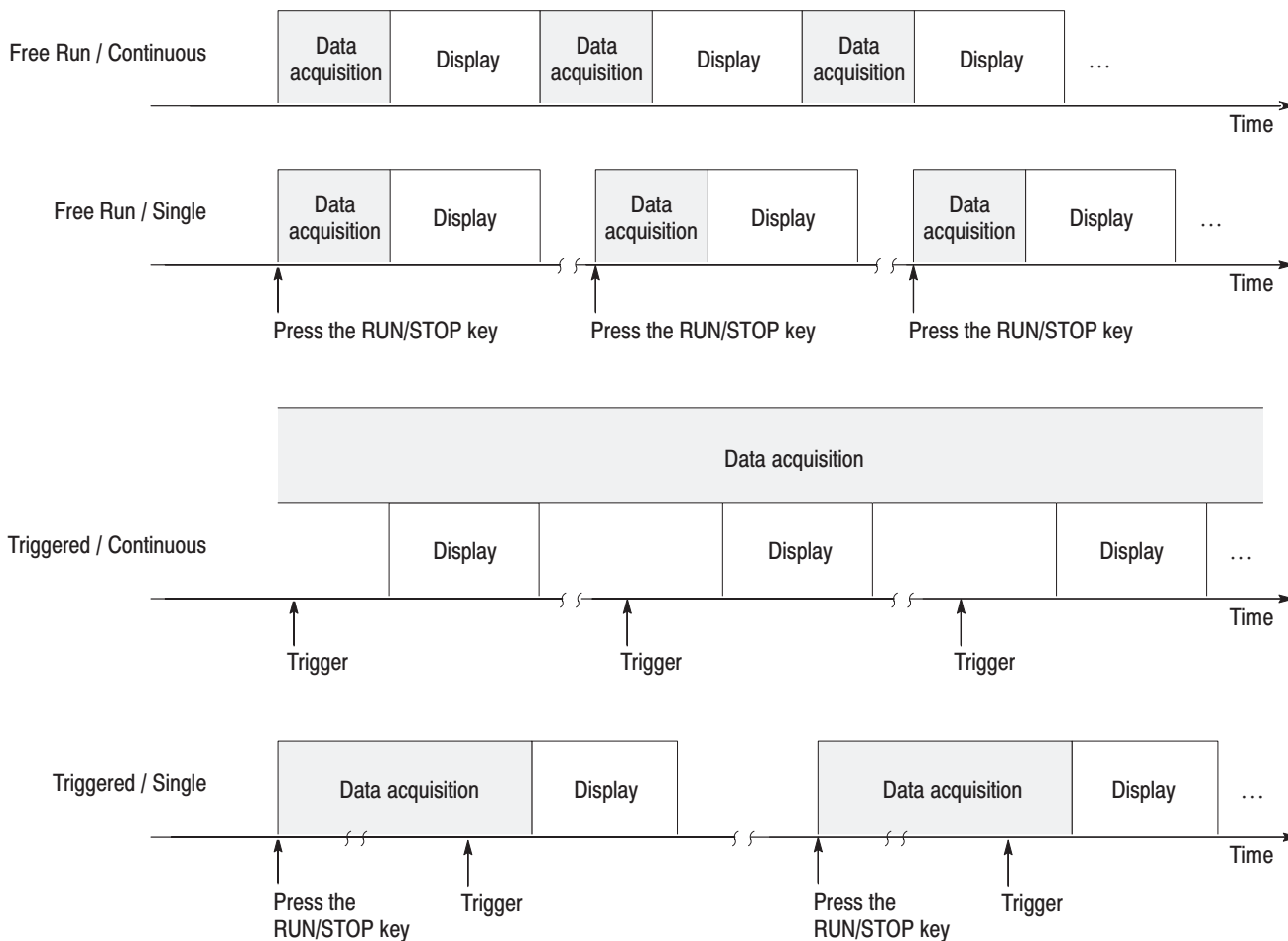

Figure 3–75: Acquiring and displaying data by Trigger and Repeat modes

IF Trigger

This section describes the IF trigger function, which operates when the trigger source is set to Level (Full BW). The IF trigger function monitors the level of signals that pass through the IF filter and generates a trigger when the level exceeds the threshold.

Setting a Trigger Level

When IF trigger is selected, the trigger level can be set in the range of 1 to 100%. The full scale of the internal A/D converter is considered as 100%. This is almost equivalent to the set value of reference level. For example, if the reference level is set to +3 dBm, 3 dBm becomes the full scale of the A/D converter. If the trigger level is set to 100%, a trigger will occur when a signal with a level higher than 3 dBm is applied.

The Figure 3–76 shows the relationship between trigger level set values and signal power that causes a trigger to be generated when the reference level is +3 dBm and the input signal is a single sine wave. If the trigger level is set to 50%, the amplitude of –6 dB from the reference level corresponds to the signal power that causes a trigger. That is:

$$+3 \text{ dBm (reference level)} - 6 \text{ dB} = -3 \text{ dBm}$$

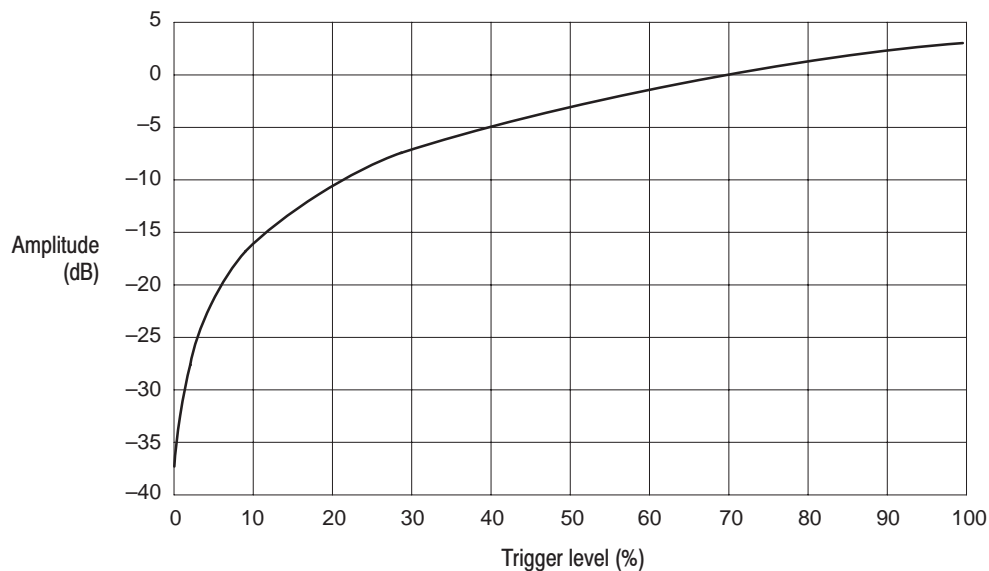

Figure 3–76: Trigger level vs. Amplitude (reference level = +3 dBm)

Time and Frequency Domain Waveforms

The trigger level to be set with IF trigger is based not on the power of the signal in the frequency domain but on the level of the signal in the time domain. Note that the relationship between signal power and trigger level varies with the input signal waveform.

A waveform made by adding sine waves of 1 Hz, 3 Hz, and 5 Hz as shown in Figure 3–77 is given as an example. Figure A shows waveforms of 1 Hz, 3 Hz, and 5 Hz respectively, and the size is 1. Figure B shows the waveforms when the above signals are added. You can see that the voltage at the largest peak is more than twice the voltage of the original signals. On the frequency axis of Figure C, only signals of size 1 are generated at 1 Hz, 3 Hz, and 5 Hz. The IF trigger compares the waveform peak in Figure B with the trigger level set value. The level is therefore different from the power level of each frequency component on the spectrum (Figure C).

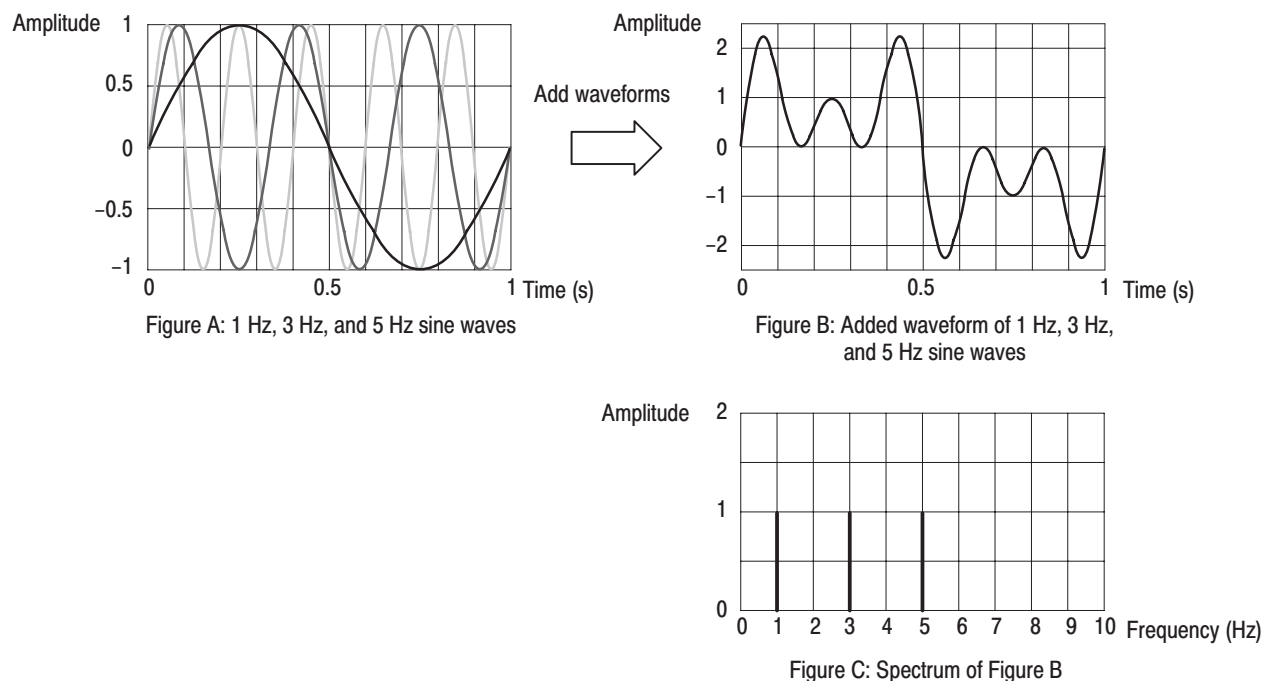

Figure 3–77: Waveforms in time domain and in frequency domain

The IF trigger always observes the signal level of the IF bandwidth of approximately 15 MHz to determine trigger generation. Even if the span is 1 MHz, the bandwidth of approximately 15 MHz is the detection target of IF trigger. Note that, as shown in Figure 3-78, any signal exceeding the trigger level other than the range of 1 MHz of span activates the IF trigger even if no signal exceeds the trigger level within the range of 1 MHz of span.

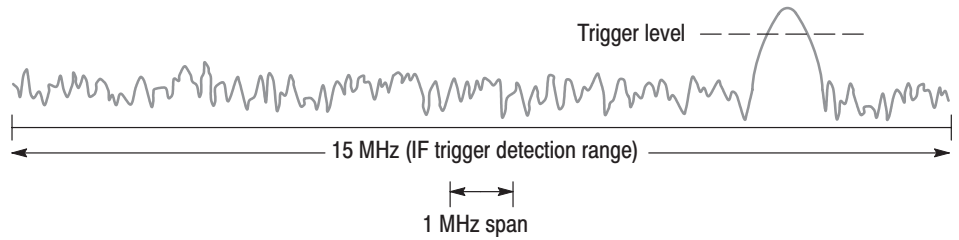

Figure 3-78: IF trigger detection range

Creating a Trigger Mask (Option 02 Only)

NOTE. The trigger mask function is available for Option 02 in the measurement mode (Mode) of the real-time spectrum analysis (Real Time S/A), the modulation analysis (Demod), and the time analysis (Time).

Trigger masks are limited to -60 dBfs.

The trigger mask (shown in Figure 3–79) is an area created on the graticule of the spectrum view (subview in the Demod and Time modes). The trigger occurs when the input signal exits or enters the area.

Real Time S/A mode

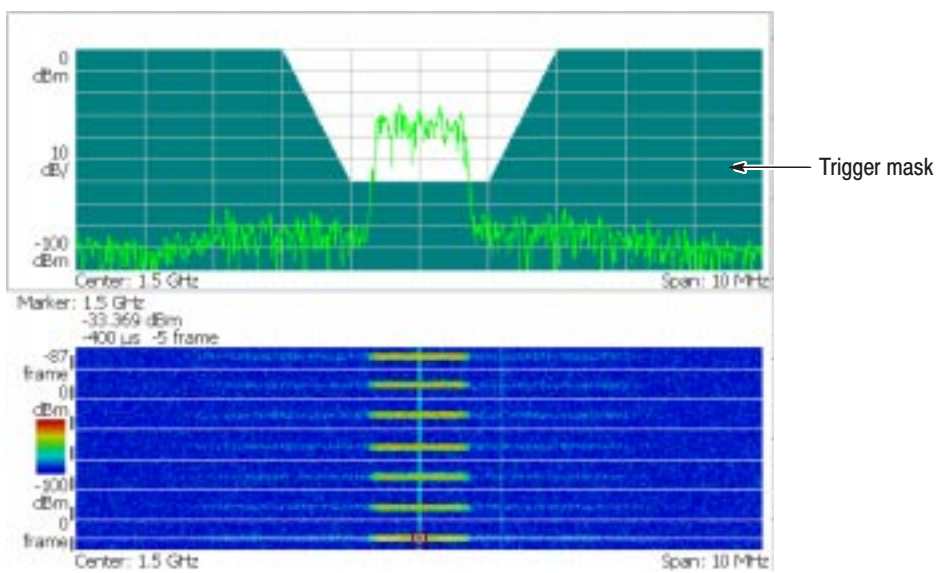

Demod and Time modes
(upper screen)

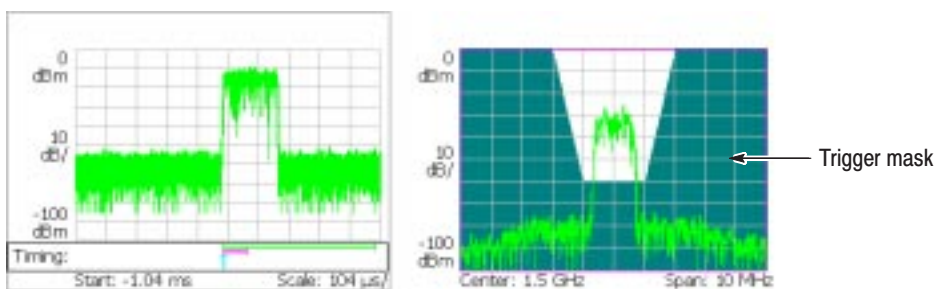

Figure 3–79: Trigger mask

Conditions for Creating a Mask

The required conditions for creating a trigger mask are as follows:

- Measurement mode (Mode): Real Time S/A, Demod, or Time
- Trigger mode (TRIG → Mode): Triggered
- Trigger source (TRIG → Source): Freq Mask

Mask Creation Menu

Use the **TRIG → Define Mask** menu and the marker (○) to create the mask.

Select Next Point. Selects the marker to control. The active marker is displayed in red.

Set Selected Point X. Sets the horizontal position of the active marker.

Set Selected Point Y. Sets the vertical position of the active marker.

Delete Selected Point. Deletes the point at the active marker position.

Insert New Point. Inserts the new point halfway between the active marker and the next marker on the right side.

Set All Points to Maximum. Fills the area below the maximum line (the reference level). See Figure 3–80.

Set All Points to Minimum. Fills the area below the minimum line (the level lower than the reference level by 60 dB). See Figure 3–80.

Reset Mask to Default. Displays the default mask. See Figure 3–80.

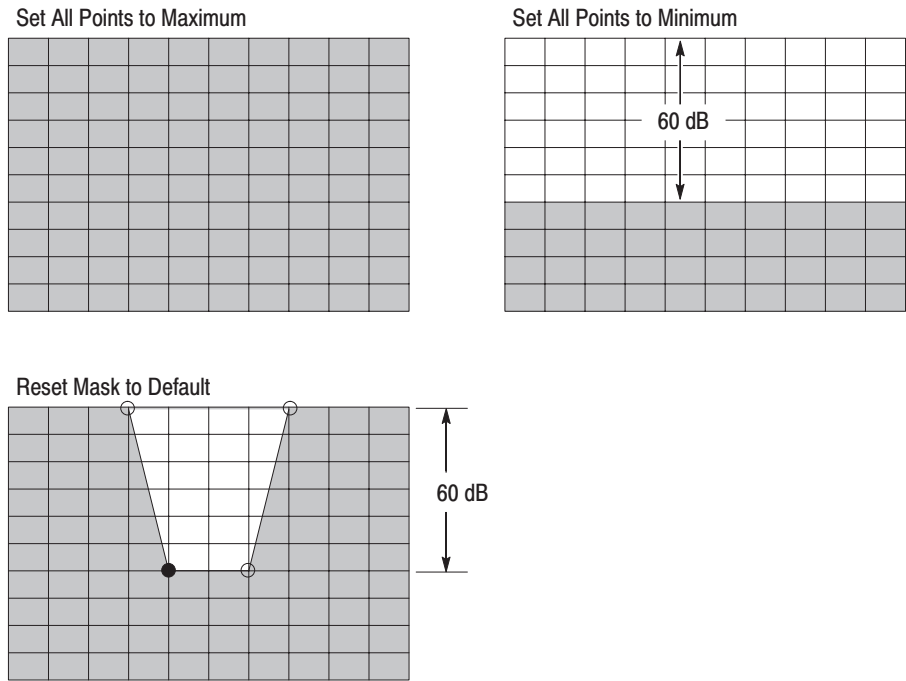

Figure 3-80: Filling operation for creating a mask

Example of Mask Creation

Create a trigger mask shown in Figure 3–81 as an example in this section.

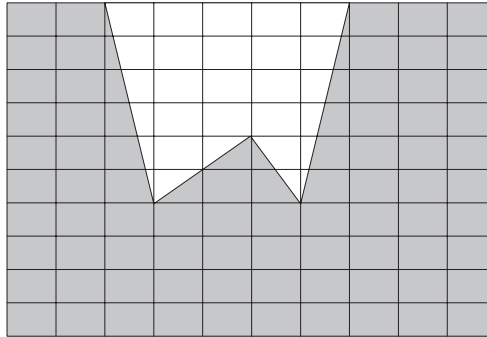

Figure 3-81: Example mask

1. Before you start creating a trigger mask, make sure that the conditions listed on page 3–124 are satisfied.
2. Stop data acquisition using the **RUN/STOP** key.
3. If necessary, display a single view of spectrum:
The trigger mask is created in the spectrum view. To display only the spectrum view on the screen, follow these steps:
 - a. Press the **VIEW: SELECT** key on the front panel to select the spectrum view.
 - b. Press the **VIEW: DEFINE** key on the front panel.
 - c. Press the **Show Views** side key and select **Single**.
4. Press the **TRIG** key on the front panel.
5. Press the **Define Mask...** side key.

The default setting is for the whole area to fill with blue on the graticule.

6. Press the **Reset Mask to Default** side key.

The default mask appears (see Figure 3–82).

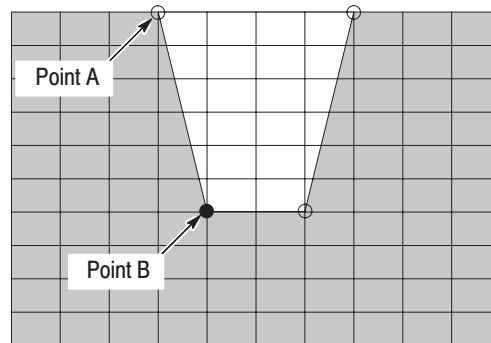

Figure 3–82: Default mask

7. Change the position of Point A:
 - a. Press the **Select Next Point** side key until Point A is selected.
 - b. Press the **Set Selected Point X** side key and set the horizontal position of Point A to two divisions from the left edge using the general purpose knob or the numeric keypad (see Figure 3–83).

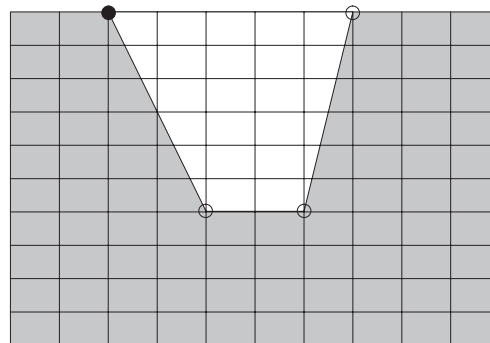

Figure 3–83: Changing the position of Point A

8. Change the position of Point B:
 - a. Press the **Select Next Point** side key to select Point B.
 - b. Press the **Set Selected Point X** side key and set the horizontal position of Point B to three divisions from the left edge using the general purpose knob or the numeric keypad (see Figure 3–84).

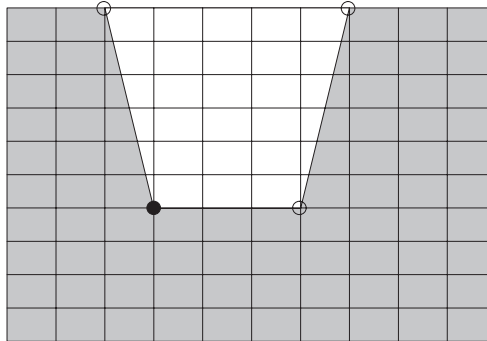

Figure 3–84: Changing the position of Point B

9. Add Point C:
 - a. Press the **Insert New Point** side key with Point B active. The new point appears halfway between Point B and the next point in the right side.
 - b. Press the **Set Selected Point X** side key and set the horizontal position of Point C to five divisions from the left edge using the general purpose knob or the numeric keypad.
 - c. Press the **Set Selected Point Y** side key and set the vertical position of Point C to four divisions from the top edge using the general purpose knob or the numeric keypad (see Figure 3–85).

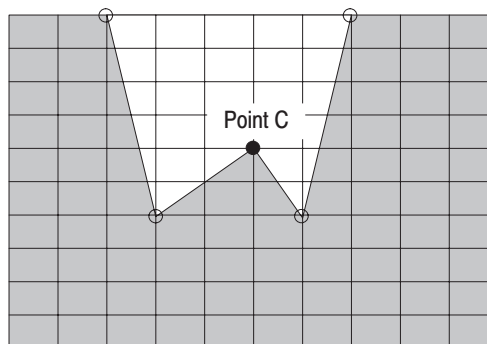

Figure 3–85: Adding Point C

The trigger mask is stored in the internal memory.

10. If you started with a multi-view display, return using the following steps:

- a.** Press the VIEW: **DEFINE** key on the front panel.
- b.** Press the **Show Views** side key and select **Multi**.

11. Set the trigger:

- a.** Press the **TRIG** key on the front panel.
- b.** Set **Slope** and **Position** appropriately.

12. Start data acquisition using the **RUN/STOP** key.

The analyzer stops data acquisition when the trigger event occurs.

The trigger mask is stored in the internal memory for each measurement mode of S/A: Real Time S/A, DEMOD: Analog Demod, Digital Demod, TIME: Transient, and CCDF. When you press the **PRESET** key on the front panel, the instrument settings are reset to the default only for the currently active mode.

Trigger Point Indicator

In the Demod (modulation analysis) and the Time (time analysis) modes, “T” is displayed in the Timing field on the overview. “T” indicates the trigger occurrence point in the Triggered mode, and is used as a reference point for setting the Timing parameters in the Free Run mode. However, “T” indicates the trigger output point when the trigger source is Power and the slope is *Rise and Fall* or *Fall and Rise*, or when the trigger source is Freq Mask.

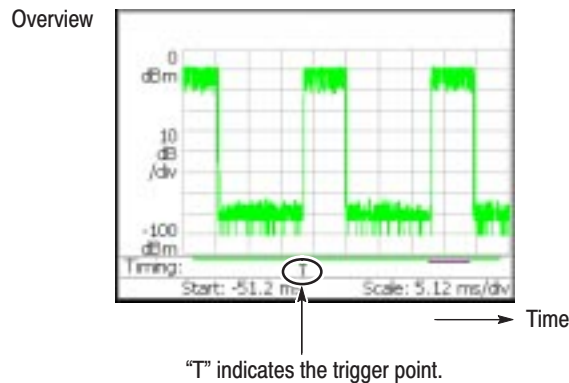

Figure 3–86: Trigger point display

Indicating Trigger Output

The trigger output is utilized to synchronize the analyzer with other instruments, for example. In the Demod (modulation analysis) and the Time (time analysis) modes, “O” indicating the trigger output point can be also displayed in the Timing field on the overview. “O” is off in default. Follow these steps to display the indicator:

1. Press the **TIMING** key on the front panel.
2. Press the **Output Trigger Indicator** side key to select **On**.

“O” appears on the overview.

The trigger output timing is determined by the analyzer hardware so that you cannot change it. For the external trigger, it coincides with the timing of the trigger occurrence. In other cases, there is no relationship between the timing of the trigger occurrence and that of the trigger output.

When you connect the trigger output to other instruments, use the TRIG OUT connector on the rear panel (see *Rear Panel* on page 2–2). The output specification is: H level >2.0 V, L level <0.4V, and output current <1 mA.

Trace Comparison Display and Average Function

In the spectrum analysis (S/A mode), you can display two traces concurrently on screen. Trace 1 is displayed in yellow and Trace 2 in green (see Figure 3–87). The trace can be averaged for noise reduction. You can save waveform data in files, and load them as Trace 1 or 2.

NOTE. Trace comparison display and average function are available in the spectrum analysis (S/A) mode except real time (Real Time S/A).

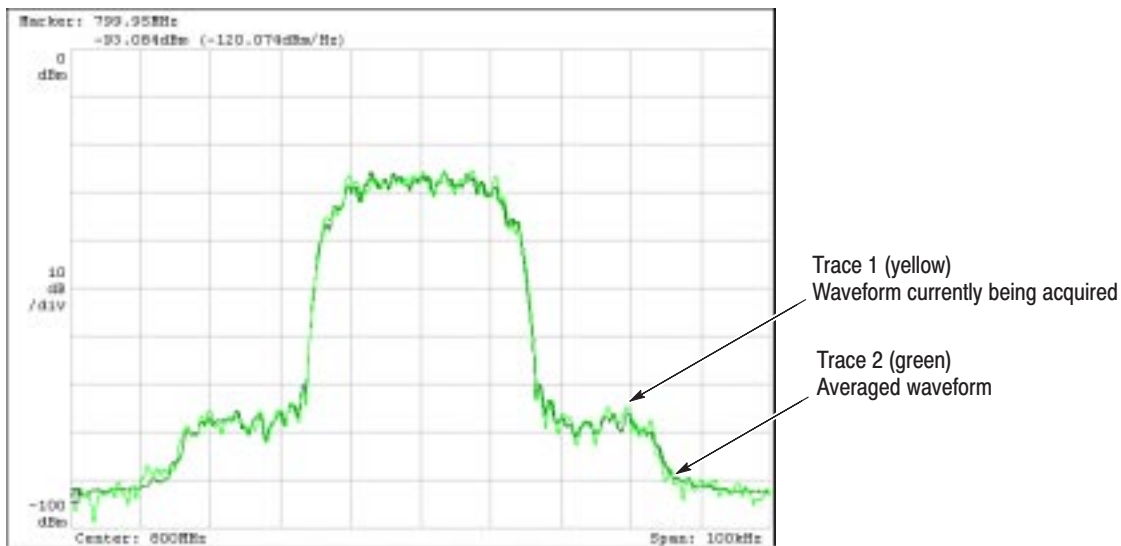

Figure 3–87: Comparison display of Trace 1 and 2

The main topics in this section are:

- Displaying Trace 1 and 2
- Averaging waveform
- Saving/Loading waveform data
- Trace compression display

Displaying Trace 1 and 2

Trace 1 and 2 are controlled using the Trace/Avg menu. Only Trace 1 (yellow) is displayed by default.

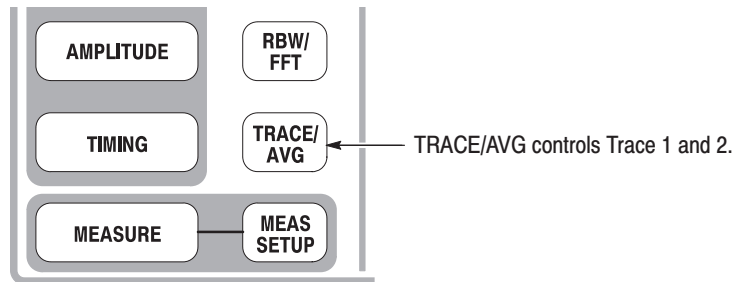

Use the following steps to select the trace:

1. Press the **TRACE/AVG** key on the front panel.
2. Press the **Select Trace** side key to select the trace (1 or 2) to be controlled. For example, to control Trace 2, select **2**.
3. Press the **Trace 1** (or **2**) side key to select the display method:
 - **On.** Turns on the selected trace.
 - **Freeze.** Stops updating waveform display to fix the screen for a waveform, but data acquisition and measurement continue.
 - **Off.** Turns off the selected trace.
4. Press the **Trace 1** (or **2**) **Type...** side key to select the trace type:
 - **Normal.** Displays the waveform without averaging.

NOTE. For information about Average, Max Hold and Min Hold, refer to Average Type on page 3–134.

- **Average.** Averages the selected trace.
 - **Max Hold.** Retains the maximum value at each data point of waveform.
 - **Min Hold.** Retains the minimum value at each data point of waveform.
5. Repeat steps 2 through 4 for Trace 1 and 2.

Averaging the Waveform

The averaging technique is generally used to average and reduce the noise of the waveform. The average function includes the peak hold, which maintains the maximum and minimum values as well as the averaging process.

Setting the Average

Press the **TRACE/AVG** key to perform the average function.

You can control the average function using the following side keys:

Select Trace. Selects the trace to be controlled: trace 1 or 2.

Trace 1/2 Type... Selects the type of processing for the selected trace. Refer to *Averaging Type* on page 3–134.

- **Average.** Averages the selected trace.
- **Max Hold.** Retains the maximum value at each data point of the waveform.
- **Min Hold.** Retains the minimum value at each data point of the waveform.

Number of Averages. Specifies how many traces are accumulated to create the averaged value. Range: 1 to 100000 (default: 20).

Averaging is controlled in two ways as shown in Table 3–19.

Table 3–19: Averaging method

Data acquisition	Average type	Number of Averages
Free run (Continuous mode only)	Exponential RMS	Continues the average with an exponential weighting applied to old values using Number of Averages as the weighting factor.
Triggered and Single mode	RMS	Averages traces accumulating up to Number of Averages, then stops the acquisition until the next trigger event occurs.

Reset Average. Causes trace accumulation to start over.

Average Type There are four averaging types as follows, where these variables are used:

$X(p)_n$: Display data for the n^{th} frame
 $x(p)_n$: Active data for the n^{th} frame
 P : Frame point
 N : Value of “Number of Averages”

RMS. Root-mean-square. Used when acquiring data in single mode. N frames average, then the acquisition stops.

$$\begin{aligned} X(p)_n &= x(p)_n && \text{for } : n = 1 \\ X(p)_n &= \frac{(n-1) \times X(p)_{n-1} + x(p)_n}{n} && \text{for } : 2 \leq n \leq N \\ X(p)_n &= x(p)_N && \text{for } : n > N \end{aligned}$$

Exponential RMS. Exponential root-mean-square. Used when acquiring data in continuous mode. Continuous averaging weights older sweeps so that they have a progressively smaller effect on the average.

$$\begin{aligned} X(p)_n &= x(p)_n && \text{for } : n = 1 \\ X(p)_n &= \frac{(n-1) \times X(p)_{n-1} + x(p)_n}{n} && \text{for } : 2 \leq n \leq N \\ X(p)_n &= \frac{(N-1) \times X(p)_{n-1} + x(p)_n}{N} && \text{for } : n > N \end{aligned}$$

Max Hold. Displays only the maximum value at each data point.

$$\begin{aligned} X(p)_n &= x(p)_n && \text{for } : n = 1 \\ X(p)_n &= \max(X(p)_{n-1}, x(p)_n) && \text{for } : n \geq 2 \end{aligned}$$

Min Hold. Displays only the minimum value at each data point.

$$\begin{aligned} X(p)_n &= x(p)_n && \text{for } : n = 1 \\ X(p)_n &= \min(X(p)_{n-1}, x(p)_n) && \text{for } : n \geq 2 \end{aligned}$$

Averaging Example

This section shows how to use averaging and the compared display.

Performing Averaging. Average and display Trace 1.

1. Display the spectrum of the measurement signal.
2. Pause data acquisition to simplify the operation. If you are acquiring the data in the continuous mode, press the **RUN/STOP** key to stop the acquisition.
3. Press the **TRACE/AVG** key on the front panel.
4. Press the **Select Trace** side key to select **1**.
5. Press the **Trace 1 Type** side key and select **Average** for example.
6. Press the **Number of Averages** side key and set **64** for example.
7. Press the **RUN/STOP** key to acquire data.
8. Press the **Reset Average** side key to perform averaging again.

The averaged waveform is displayed on screen (see Figure 3–88). The average count is indicated in the right top portion of the screen.

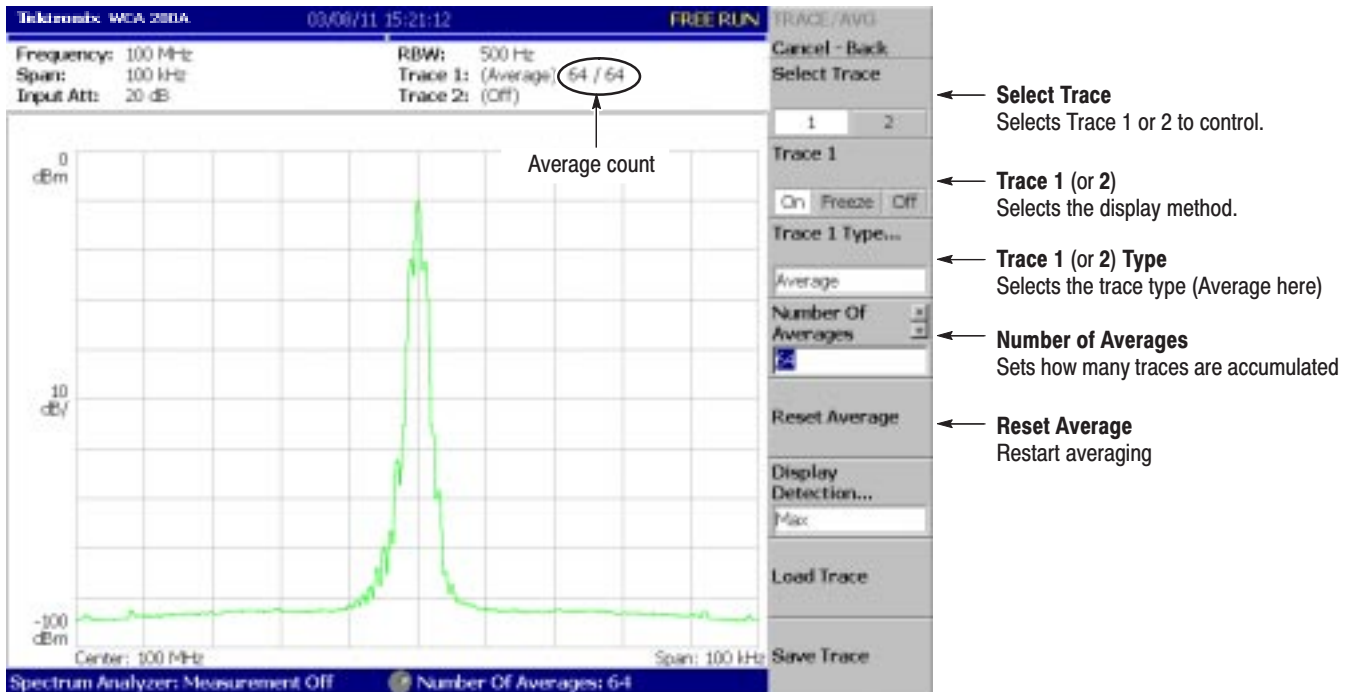

Figure 3–88: Displaying an averaged waveform

Compared Display. Display Trace 1 as a normal spectrum and Trace 2 as the averaged waveform concurrently, and compare them.

1. Display the spectrum of the measurement signal.
2. Press the **TRACE/AVG** key on the front panel.
3. Display Trace 1 as a normal spectrum.
 - a. Press the **Select Trace** side key to select **1**.
 - b. Press the **Trace 1 Type...** side key and select **Normal**.
4. Display Trace 2 as the averaged waveform.
 - a. Press the **Select Trace** side key to select **2**.
 - b. Press the **Trace 2 Type...** side key and select **Average, Max Hold** or **Min Hold**.

The waveform currently being acquired (trace 1 in yellow) and the averaged waveform (trace 2 in green) are displayed together.

Figure 3–89 shows an example of the concurrent display of the ordinal spectrum and its Max Hold waveform.

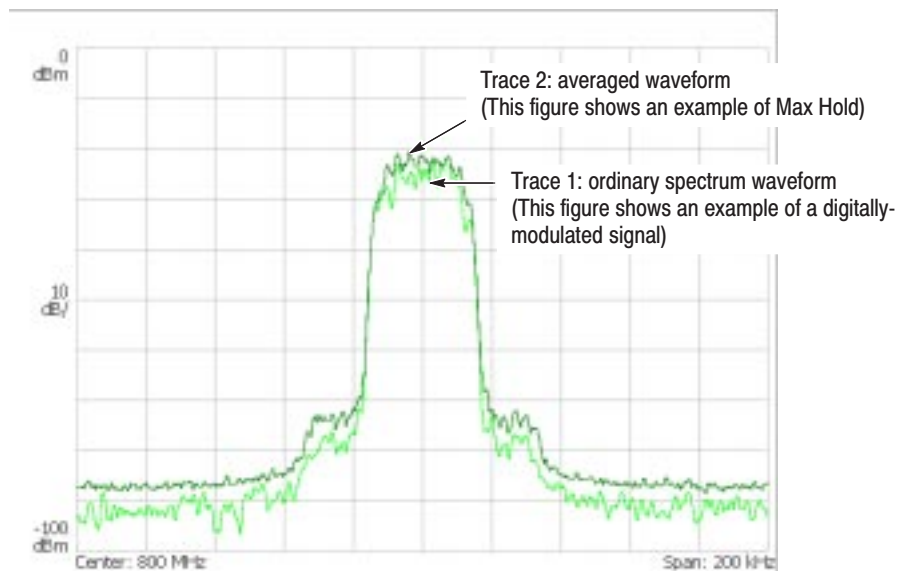

Figure 3–89: Compared display

Saving/Loading Waveform Data

You can save the waveform data currently being acquired in a file, and load the saved data as trace 1 or 2.

Saving a Trace

Save Trace 1 or 2 in a file.

1. Press the **TRACE/AVG** key on the front panel.
2. Press the **Select Trace** side key to select Trace 1 or 2.
3. Press the **Save Trace** side key and select the destination file.
For information about file operations, refer to page 3–153 and subsequent pages.

Loading a Trace

Load Trace 1 or 2 from a file.

1. Press the **TRACE/AVG** key on the front panel.
2. Press the **Select Trace** side key to select Trace 1 or 2.
3. Press the **Load Trace** side key and select the source file. (The trace is automatically frozen.) For information about file operations, refer to page 3–153 and subsequent pages.

Trace Compression

Although waveform data are acquired as 1024 points per frame, the acquired data are displayed after being thinned out and compressed due to the limitation of the number of pixels on screen. The compression method and the procedure to select the method are described in the following section.

Relation between Frame, Bin, and Pixel

One frame contains FFT points (1024) of data. Part of the data in the frame is invalid for the calculation. This instrument discards invalid data and displays only valid data. Valid data are called “bin”. The number of bins depends on the span and the number of FFT points as shown in Table 3–20.

Table 3–20: Number of bins (FFT points: 1024)

Span	Number of bins
2 MHz or less	641
5 MHz	801
10 MHz	801
15 MHz	601
20 MHz (Baseband only)	801

The number of bins is valid in all modes except Scalar mode. The number of bins is meaningless in Scalar mode because it uses several physical frames to display data. Generally, the following calculations are used:

$$\text{Frequency bandwidth of one bin} = (\text{Sampling rate}) / (\text{Number of FFT points})$$

$$\text{Number of bins} = (\text{Specified span}) / (\text{Frequency bandwidth of one bin}) + 1$$

The sampling rate varies depending on span. Refer to page A–7 in *Appendix A: Specifications* for more details.

Compression Method

Generally, because the number of horizontal pixels on screen is smaller than the number of bins, bin data is compressed according to the number of pixels on screen when they are displayed (see Figure 3–90).

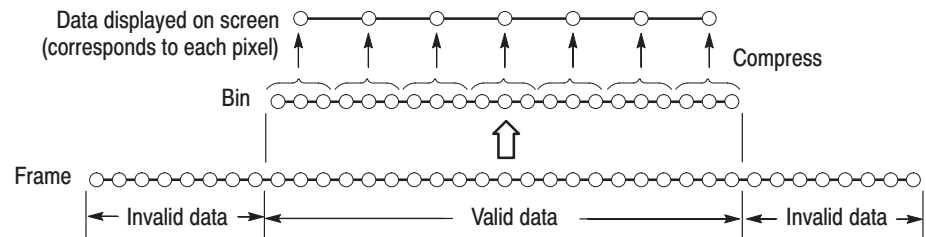

Figure 3–90: Relationships between frame, bin, and pixel

There are three types of compression methods: Max, Min, and Max-Min (see Figure 3–91).

Selecting Compression Method

Max is the most commonly used compression method. Max-Min is used in the time domain waveform display in the DEMOD mode. (The compression method is always set to Max on the spectrogram view in three-dimensional modes.)

You can select the compression method using the following steps in S/A mode:

1. Press the **TRACE/AVG** key on the front panel.
2. Press the **Display Detection...** side key and select **Max**, **Min**, or **Max-Min**.

NOTE. *Display Detection determines how to deal with data between spectrum display points. The analyzer performs RMS detection using the linear A/D converter regardless of the Display Detection setting.*

Max

Acquires the maximum value of data points corresponding to each pixel.

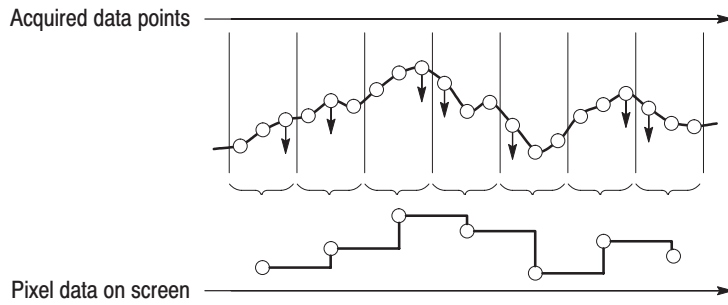

Min

Acquires the minimum value of data points corresponding to each pixel.

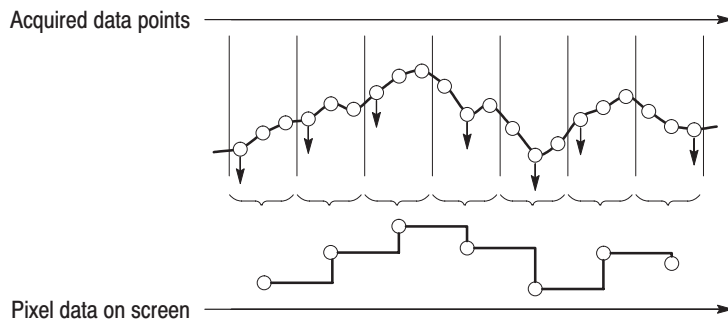

Max-Min

Acquires the minimum and maximum values of data points corresponding to each pixel.

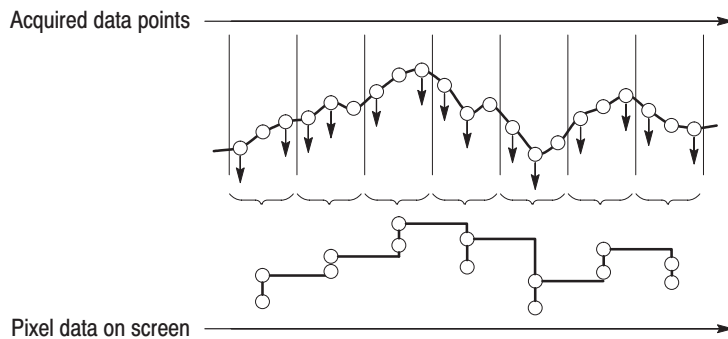

Figure 3-91: Compression method for displaying the waveform

Marker Operation and Peak Search

The marker moves on a waveform to measure amplitude or frequency. One or two markers can be displayed on the screen. There is another measurement method, which uses the reference cursor together with the marker. The marker is also used for peak search. For information on the band power marker used in the spectrum analysis, refer to *Spectrum Analysis (S/A mode)* on page 3–1.

These items are explained in this section:

- Marker Operation
- Peak Search

Marker Operation

Operate the marker with the Markers menu.

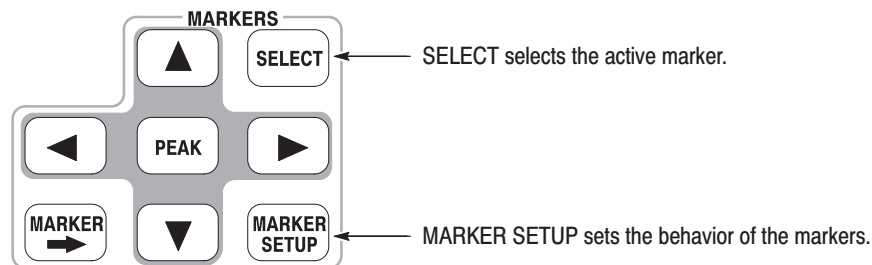

One or two markers can be displayed on the screen.

- **Single marker mode**
One marker (called Marker 1) indicated by “□” moves on a waveform. It is used to measure absolute values.
- **Delta marker mode**
Two markers (called Marker 1 and 2) indicated by “□” and “◇” move on a waveform. “□” and “◇” represent an active and a fixed marker, respectively. They are used to measure relative values.

NOTE. If multiple views are displayed on one screen, before operating the markers, press the VIEW: SELECT key on the front panel to select the view in which you want to operate the markers. The selected view is enclosed by a white frame.

Measuring with a Single Marker

To measure amplitude or frequency with a single marker, follow these steps:

1. Press the **MAKER SETUP** key on the front panel.
2. Press the **Makers** side key to select **Single**.

Only Marker 1 is enabled.

Note that the **Marker X Position** menu item is already selected.

3. Rotate the general purpose knob (or enter the value using the numeric keypad) to move the marker to the measurement location.

The marker readout is displayed in the top left portion of the screen (see Figure 3–92).

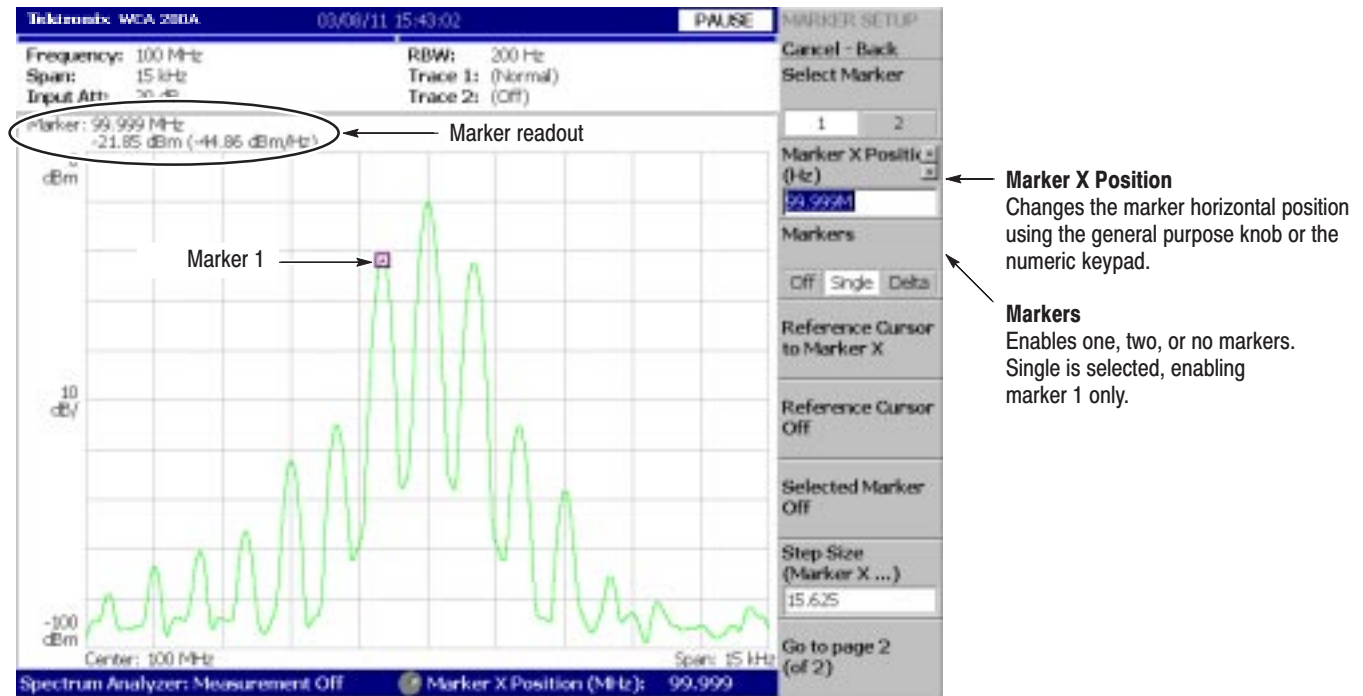

Figure 3–92: Measurement with a single marker

Measuring with the Delta Marker

To measure differences in amplitudes or frequencies using the delta marker, follow these steps:

1. Press the **MAKER SETUP** key on the front panel.
2. Press the **Makers** side key to select **Delta**.

Marker 1 and 2 are displayed, with the two markers overlapping each other. **Select Marker** is set to **1** (Marker 1) by default.

Note that the **Marker X Position** menu item is already selected.

3. Rotate the general purpose knob (or enter the value using the keypad) to move the active marker to the reference point.
4. Change the active marker by pressing the **Select Marker** side key to select **2**.
5. Rotate the general purpose knob (or enter the value using the keypad) to move the active marker to the measurement point.

As shown in Figure 3–93, the marker readout is shown in the top left portion of the screen:

$$(\text{Delta marker readout}) = (\text{Marker 1 readout}) - (\text{Marker 2 readout})$$

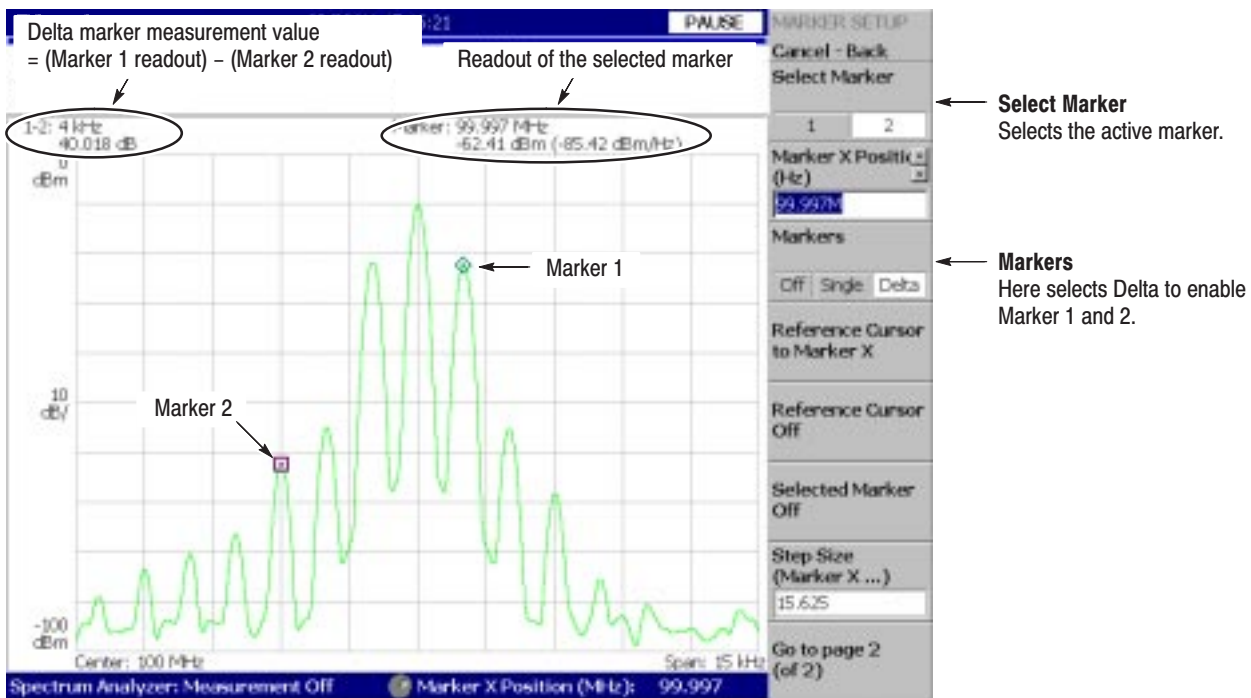

Figure 3–93: Using the delta marker to take measurements

Measuring with the Reference Cursor

The reference cursor is another way to measure relative amplitude or frequency. The reference cursor is positioned with the marker and fixed on the screen.

1. Press the **MAKER SETUP** key on the front panel.
2. Press the **Makers** side key to select **Single** or **Delta**.
3. Press the **Marker X Position** side key and rotate the general purpose knob (or enter the value using the keypad) to move the marker to the reference point.
4. Press the **Reference Cursor to Marker X** side key to display the cursor at the marker position.

Demod and Time modes only:

On the overview, you can also place the reference cursor at a trigger output position with the **Reference Cursor to Trigger** side key.

5. Press the **Marker X Position** side key and rotate the general purpose knob (or enter the value using the keypad) to move the marker to the measurement point.

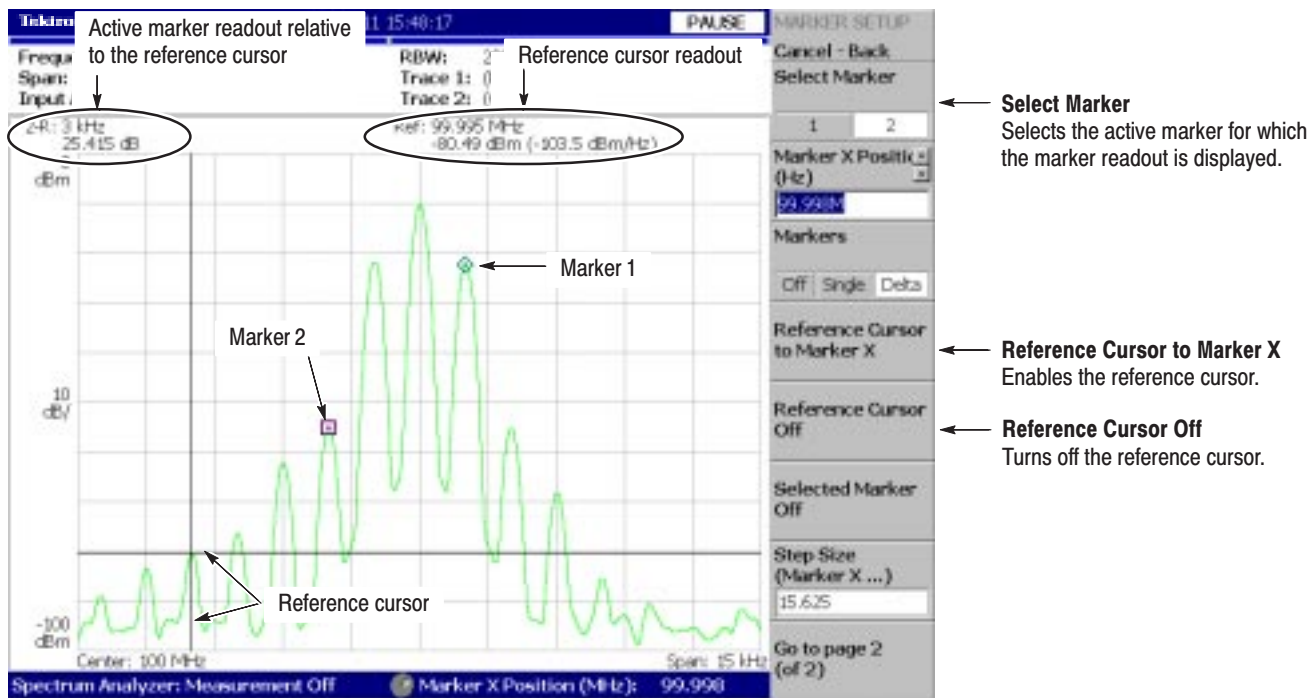

Figure 3-94: Measurement with the reference cursor

As shown in Figure 3–94, the marker readout relative to the reference cursor is shown at the top left portion of the screen for the active marker selected using the **Select Marker** side key.

To turn off the reference cursor, press the **Reference Cursor Off** side key.

Changing the Trace

Use the following steps to change the trace on which you operate the marker when displaying two traces on a view. Trace 1 is displayed in yellow and Trace 2 in green.

In the S/A (spectrum analysis) mode, two traces are shown when Trace 2 is turned on using the TRACE/AVG menu.

In DEMOD (modulation analysis) mode and TIME (time analysis) mode, two traces are shown in IQ vs. Time view (I level vs. time and Q level vs. time).

1. Press the **MAKER SETUP** key on the front panel.
2. Press the **Go to page 2 (of 2)** (bottom) side key to show the next menu page.
3. Press the **Assign Marker X to Trace** side key to select Trace 1 or 2, as shown in Figure 3–95.

The marker moves to another trace with the same horizontal position.



Figure 3–95: Changing the Trace

Interlock of the Markers

When you display multiple views on one screen, markers displayed in those views interlock each other.

Figure 3–96 shows a concurrent display of the spectrum and the spectrogram. If you move the marker to the left on the spectrum, the marker on the spectrogram moves to the left in accordance with that movement. Conversely, if you move the marker on the spectrogram to the left, the marker on the spectrum moves to the left.

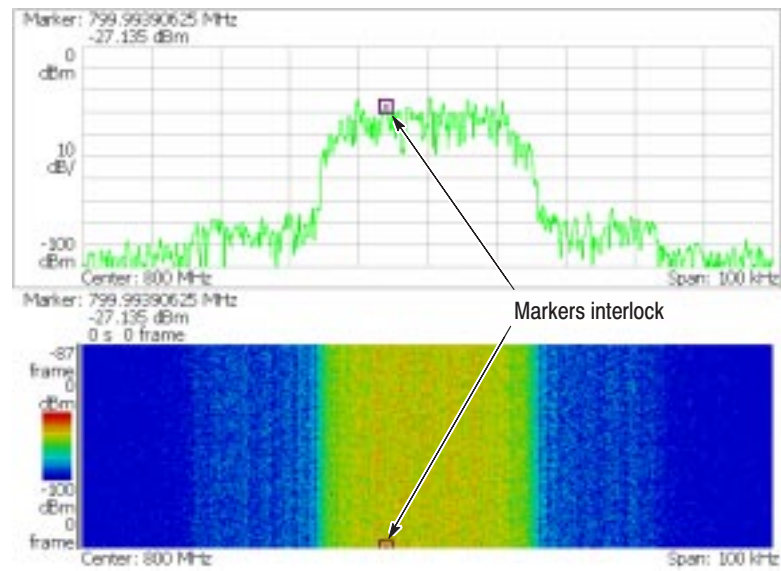
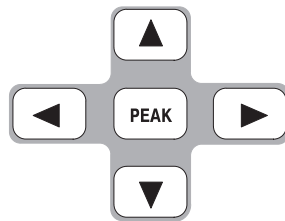

Figure 3–96: Interlock of markers

Peak Search

The peak search function searches for the peak on the waveform and moves the marker to the peak position. Use the **PEAK** and marker left/right/up/down (◀▶▲▼) keys on the front panel for peak search.



Functions of the Peak Search keys

The peak search keys have the following functions (see Figure 3–97):

PEAK Positions the marker to the highest peak signal.

- ◀ Moves the marker lower in frequency to the next signal.
- ▶ Moves the marker higher in frequency to the next signal.
- ▲ Moves the marker higher in amplitude to the next signal.
- ▼ Moves the marker lower in amplitude to the next signal.

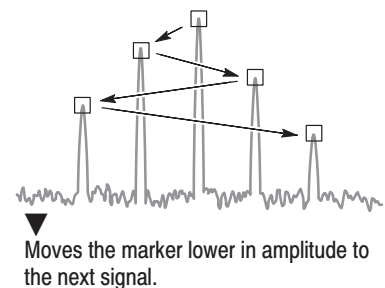
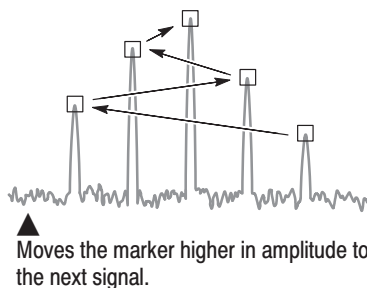
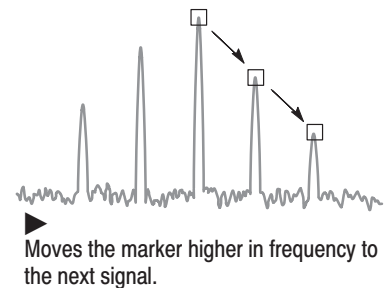
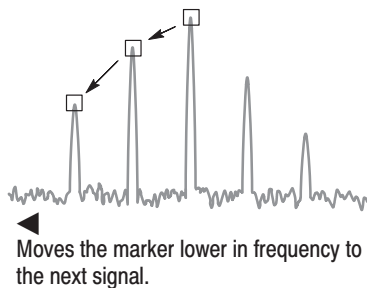
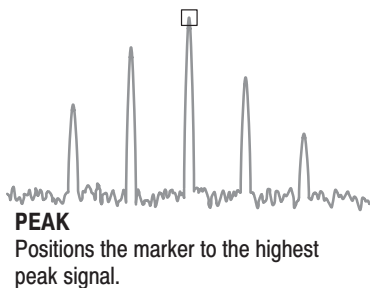

Figure 3–97: Functions of the peak search keys

Setting the Minimum Jump of the Marker

The definition of “next” can be set in the MARKER SETUP menu using the following parameters:

Peak Search Freq. Threshold. *S/A mode only.* Sets the minimum frequency jump that should be made when selecting the next signal to the left/right/up/down.

Peak Search Hor. Threshold. *Demod and Time modes only.* Selects the minimum horizontal jump that should be made when selecting the next signal to the left/right/up/down.

For example, when Peak Search Freq. Threshold is set to 1 kHz, the next peak is recognized if it is 1 kHz or more distant from the first peak (see Figure 3–98).

Example: Peak Search Freq. Threshold = 1 kHz

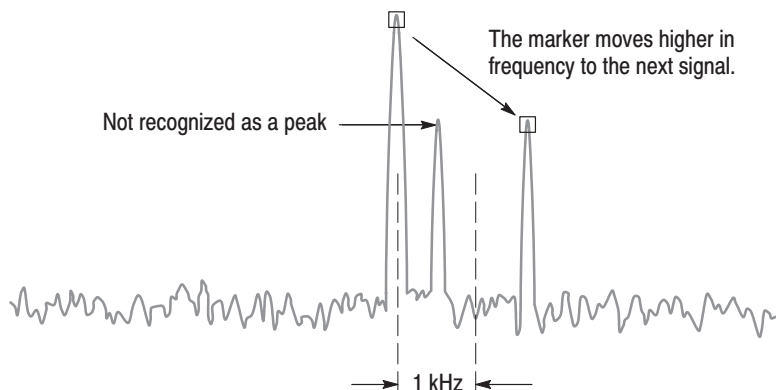

Figure 3–98: Setting the minimum frequency jump

Use the following steps to set the minimum jump:

1. Press the **MAKER SETUP** key on the front panel.
2. Press the **Go to page 2 (of 2)** (bottom) side key to show the next menu page.
3. Press either of the following side keys depending on the measurement mode and then set the minimum jump:
 - **Peak Search Freq. Threshold** in the *S/A* mode
 - **Peak Search Hor. Threshold** in the *Demod* and *Time* modes

Display Line

The analyzer provides a convenient method to determine whether a signal peak is higher or lower than a specified level, or whether it falls within a specified range.

Use the LINES menu to control the display lines.

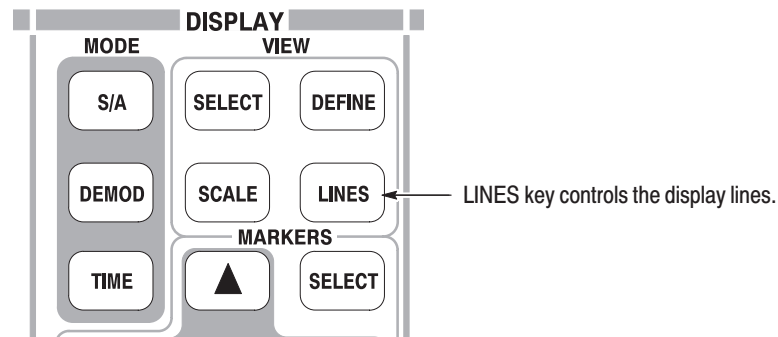

The Display Line feature displays horizontal and/or vertical line(s) at the position you specify.

Figure 3–99 shows one horizontal and one vertical line, Figure 3–100 shows two horizontal lines, and Figure 3–101 shows two horizontal and two vertical lines. You can visually compare the signal amplitude and frequency of the lines.

NOTE. The display line is available only in the S/A (spectrum analysis) mode.

There are two types of lines: horizontal line and vertical line. You can display one or two of each line. You can display the horizontal and vertical lines concurrently. The value at the position is indicated on the line.

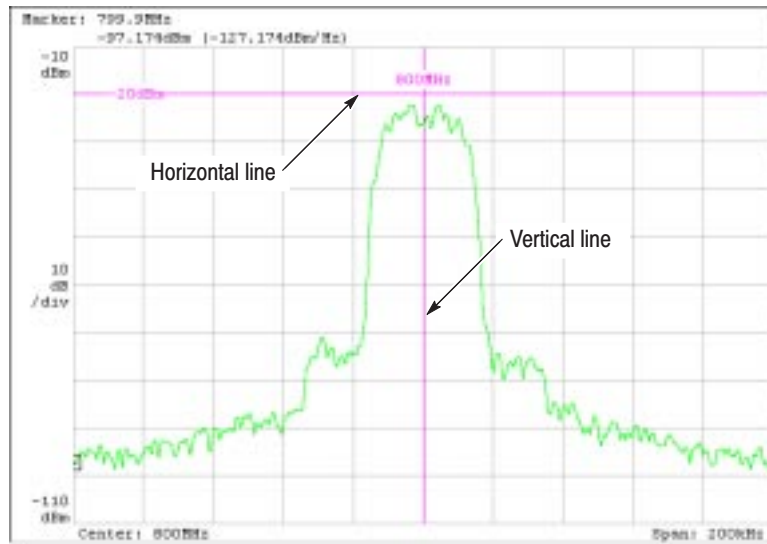

Figure 3-99: Horizontal and vertical line

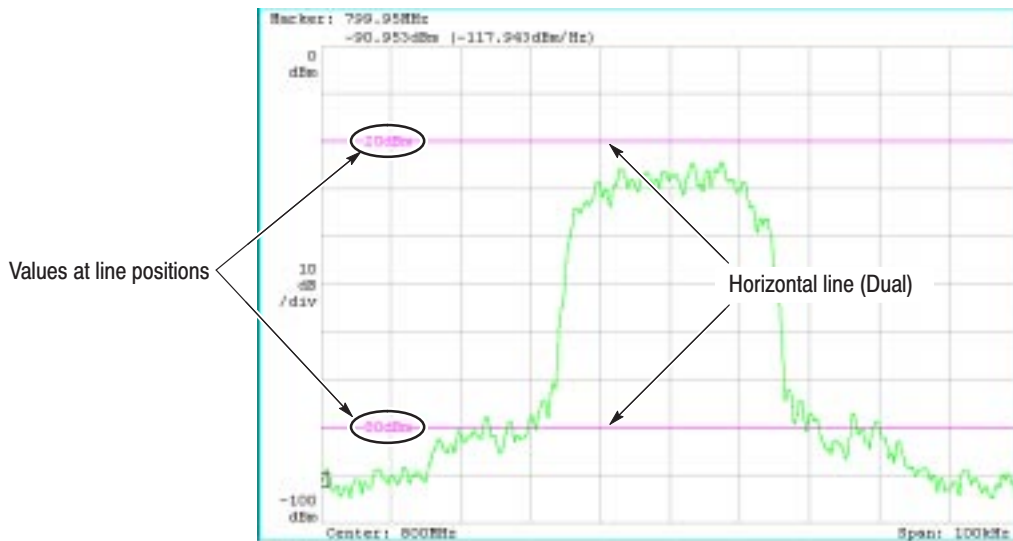

Figure 3-100: Two horizontal lines

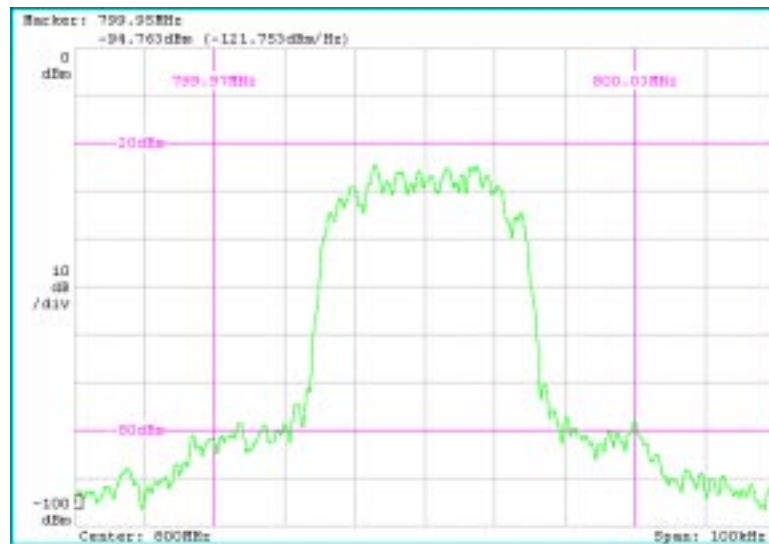

Figure 3-101: Two horizontal and two vertical lines

Horizontal Display Line

1. Press the **LINES** key on the front panel.
2. Press the **Show Line** side key to select **Horizontal**.
3. Perform one of the following options.
 - *When displaying one horizontal line:*
Press the **Number Of Line** side key to select **1**.

Press the **Line 1** side key and move the line using the general purpose knob or the numeric input keypad.
 - *When displaying two horizontal lines:*
Press the **Number Of Line** side key to select **2**.

Press the **Line 1** side key and move line 1 using the general purpose knob or the numeric input keypad. Line 2 moves in parallel.

Press the **Line 2** side key and move line 2 using the general purpose knob or the numeric input keypad.

Press the **Delta** side key and move line 2 using the general purpose knob or the numeric input keypad. The delta value indicates the following value: (value of Delta) = (value of line 2) – (value of line 1)
 - *When turning off the horizontal line:*
Press the **Number Of Line** side key to select **None**.

Vertical Display Line

1. Press the **LINES** key on the front panel.
2. Press the **Show Line** side key to select **Vertical**.
3. Perform one of the following options.
 - *When displaying one vertical line:*
Press the **Number Of Line** side key to select **1**.

Press the **Line 1** side key and move the line using the general purpose knob or the numeric input keypad.
 - *When displaying two vertical lines:*
Press the **Number Of Line** side key to select **2**.

Press the **Line 1** side key and move line 1 using the general purpose knob or the numeric input keypad. Line 2 moves in parallel.

Press the **Line 2** side key and move line 2 using the general purpose knob or the numeric input keypad.

Press the **Delta** side key and move line 2 using the general purpose knob or the numeric input keypad. The delta value indicates the following value: $(\text{value of Delta}) = (\text{value of line 2}) - (\text{value of line 1})$
 - *When turning off the vertical line:*
Press the **Number Of Line** side key to select **None**.

File Operations

The instrument settings and waveform data can be saved in or loaded from files on the hard disk or 3.5 inch disk. Figure 3–102 shows the 3.5 inch disk drive.

This section describes how to handle files, containing the following topics:

- Using a Disk
- File Type
- Saving and Loading Files
- Entering a File Name
- Deleting a File
- Making/Deleting a Directory

Using a Disk

You can use a 2HD (1.44 M bytes) or 2DD (720 K bytes) 3.5-inch disk formatted for MS-DOS.

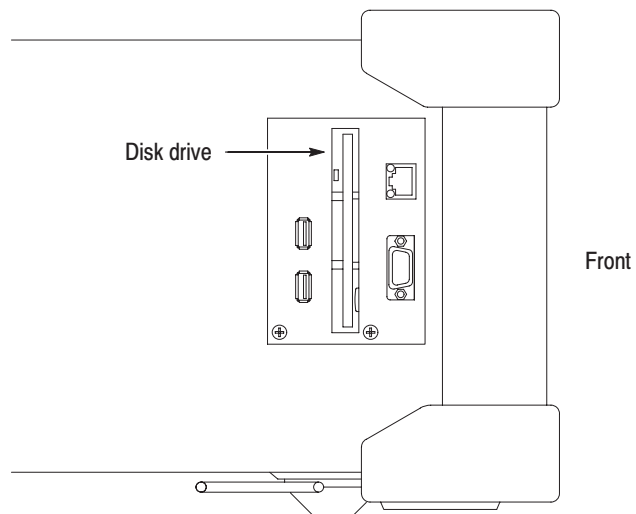

Figure 3–102: Disk drive (side panel)

File Type

The analyzer can make files with the following extensions:

- **.STA** (Status file)
A status file used to save all the current menu settings. You can save the settings you frequently use and reset the analyzer any time by loading the settings from this file.
- **.IQT** (Data file)
A file used to save time-domain waveform data acquired on the data memory in the Demod (Modulation Analysis) and the Time (Time Analysis) modes. I, Q, and T stand for in-phase, quadrature phase, and time domain, respectively.
- **.TRC** (Trace file)
A file used to save Trace 1 or 2 in the S/A (Spectrum Analysis) mode. The data in this file is loaded as the reference waveform in comparison displays between Trace 1 and 2, for example.
- **.COR** (Amplitude correction file)
A file used in the S/A (Spectrum Analysis) mode to save an amplitude correction table. The data in this file is loaded when the amplitude correction is performed. Refer to page 3–91 for the amplitude correction.

Saving and Loading Files

For saving and loading files, use the **SAVE** and **LOAD** keys on the front panel.

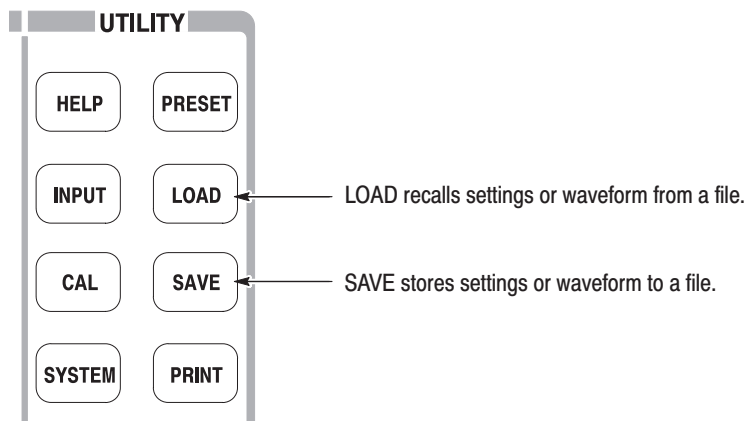

Saving a File

Use the following steps to save settings or waveforms to a file. There are two ways to save data to a file: using the preset file name and entering a new file name. When you want to return to the previous menu, press the **Cancel - Back** side key at any time.

NOTE. You cannot save data in an existing file.

1. Press the **SAVE** key on the front panel.
2. Press one of the following side keys, depending on the type of data to save:

Table 3–21: File save operation

Meas. mode	Side key	Save content	Ext.
S/A (except Real Time)	Save State	Current instrument settings	.sta
	Save Trace 1	Trace 1 waveform	.trc
	Save Trace 2	Trace 2 waveform	.trc
	Save Correction	Amplitude correction data	.cor
Real Time S/A	Save State	Current instrument settings	.sta
	Save Data	Acquired data in time domain	.iqt
Demod / Time	Save State	Current instrument settings	.sta
	Save Data...	Acquired data in time domain	.iqt
	All Blocks	Data of all blocks	
	Current Block	Data of the block currently displayed	
	Current Area	Data currently shown in the main view	

3. To enter a new file name, skip to step 5.
4. To use a preset file name, press the **Save to file name** side key (see Figure 3–103 as an example).



Figure 3–103: Save to the preset file (lower right of the screen)

There are three preset names for each file type as shown in Table 3–22.

Table 3–22: Preset file names

File type	Save file name
State (.sta)	StateA, StateB, StateC
Data (.iqd)	IQDataA, IQDataB, IQDataC
Trace (.trc)	TraceA, TraceB, TraceC
Correction (.cor)	CorrA, CorrB, CorrC

The data is saved to the file with that name in the C:\My Documents folder. The file extension is automatically added according to the file type.

5. To enter a new file name:
 - a. Press the **Folder...** side key.
 - b. Select the destination folder using the following menu items (see Figure 3–104):
 - **+Open Folder** opens the selected folder.
 - **Select Folder** selects a folder.
 - **–Close Folder** closes the selected folder.
 - **Done** accepts the selected file.

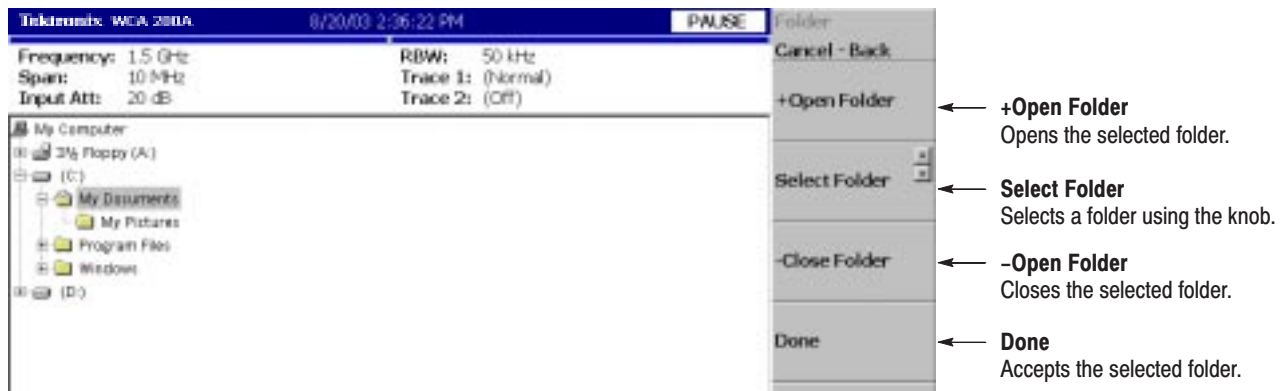

Figure 3–104: Selecting the folder

- c. After selecting the folder, press the **Done** side key to accept it. The list of files in the selected folder appears, displaying only files with the same extension as the file to be stored.
- d. Press the **Filename** side key (see Figure 3–105) and enter a file name using the front-panel keypad. The file extension is automatically added. Refer to *Entering a File Name* on page 3–160 for details about how to enter the name.

Here, input “TRACE1” for example, using the front-panel keypad.

- Press the **TUV** (number **2**) key once to select the letter “T” and then press the **ENTER** key.
 - Press the **PQRS** (number **1**) key three times to select the letter “R” and then press the **ENTER** key.
 - Press the **ABC** (number **8**) key once to select the letter “A” and then press the **ENTER** key.
 - Press the **ABC** (number **8**) key three times to select the letter “C” and then press the **ENTER** key.
 - Press the **DEF** (number **9**) key twice to select the letter “E” and then press the **ENTER** key.
 - Press the **PQRS** (number **1**) key five times to select the letter “1” and then press the **ENTER** key.
- e. After entering the file name, press the **Save File Now** side key

The data is saved to the specified file.

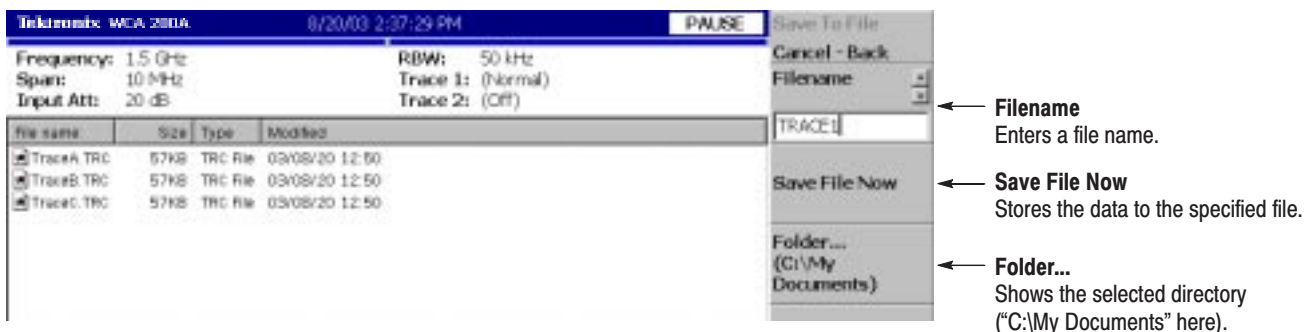

Figure 3–105: Save to File menu

Loading a File

Use the following steps to load settings or waveform from a file. There are two ways to load data from a file: selecting the preset file and selecting a file by name. When you want to return to the previous menu, press the **Cancel - Back** side key at any time.

1. Press the **LOAD** key on the front panel.
2. Press one of the following side keys according to the type of data to load:

Table 3–23: File load operation

Meas. mode	Side key	Load content	Ext.
S/A (except Real Time)	Load State	Instrument settings	.sta
	Load Trace 1	Trace 1 waveform	.trc
	Load Trace 2	Trace 2 waveform	.trc
	Load Correction	Amplitude correction data	.cor
Real Time S/A, Demod or Time	Load State	Instrument settings	.sta
	Load Data	Acquired data in time domain	.iqt

3. To select a file by name, skip to step 5.
4. To select the preset file to which you have saved data in step 4 on page 3–155, press the **Load from file name** to load the data (see Figure 3–106 as an example). The file extension is automatically added according to the file type.

NOTE. If you have not saved any data to the preset file that you select, the error message “File name not found” appears on the bottom left of the screen.



Figure 3–106: Load from the preset file (lower right of the screen)

5. To select an existing file, press the **Folder...** side key. Select the folder containing the file to be loaded. (For a file select procedure, see step 5 on page 3–156.)

6. After selecting the folder, press the **Done** side key to accept it.

The list of files in the selected folder appears.

7. Press the **Select File** side key and then select the file from the list using the general purpose knob.

8. After selecting the file, press the **Load File Now** side key. See Figure 3–107.

The data is loaded from the specified file.

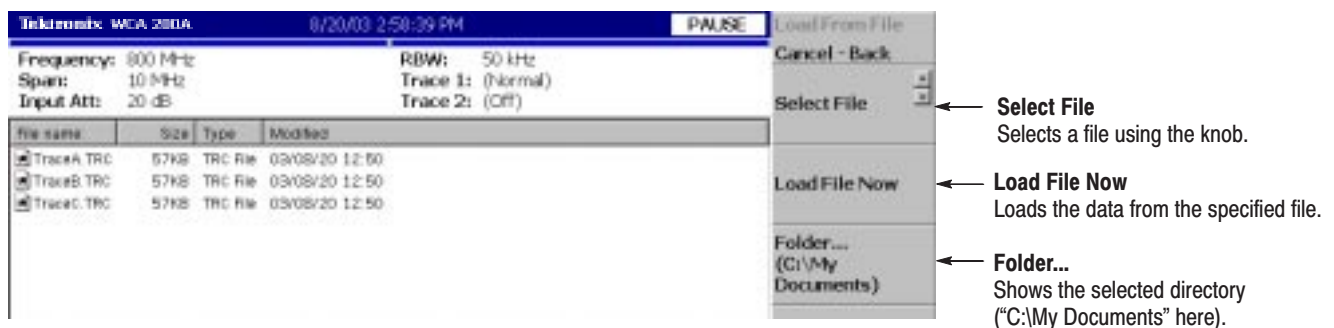

Figure 3–107: Load from File menu

NOTE. In the Real Time S/A, the Demod, and the Time modes, when you abort data acquisition before it is completed, such as in a trigger-armed state, the last data block is empty. Therefore, when you save all the blocks to a file and then load the file, the waveform does not appear at first. If you have acquired multiple blocks, select an old block to display the waveform.

Entering a File Name

When you select the file or the directory from the list, the file name or the directory name is displayed in the upper part of the screen.

Use the keypad on the front panel to input a file name (see Figure 3–108).

- **0 to 9** and **“.”** keys are used to enter alphabetic characters, numbers, punctuation and special characters indicated above each key. For example, the **8** key inputs A, B, and C, as well as 8. Each time you press the key, the selected character moves through the list: A → B → C → 8 ...
- **CAPS LOCK** key toggles a character between uppercase and lowercase.
- **BKSP** (backspace) key deletes the character just before the cursor.
- **ENTER/NEXT** key accepts the input character.

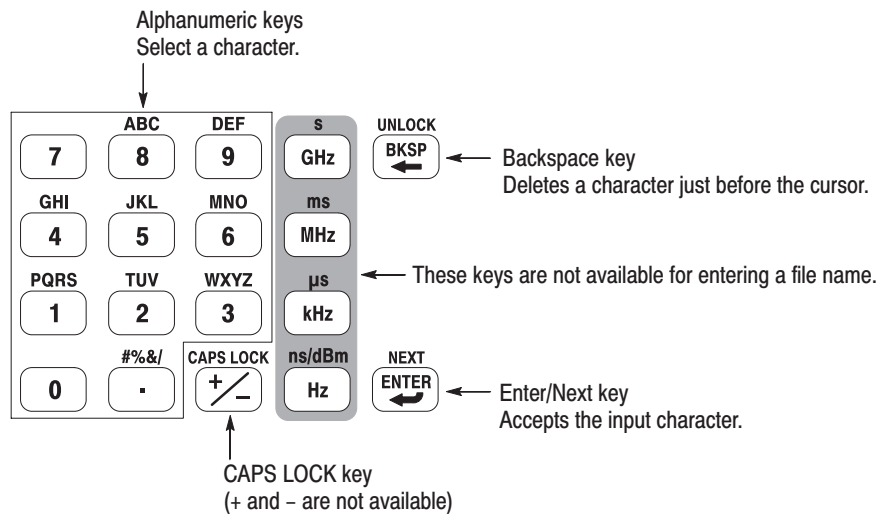
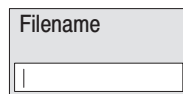

Figure 3–108: Alphanumeric keypad

Procedure To enter a new name, SAMPLE1, use the following steps:

1. Press the **Filename** side key.

The cursor appears on the left end in the text box.



A rectangular box with a grey header labeled "Filename" and a white text input area below it. A vertical cursor is positioned at the left end of the text input area.

2. Press the **PQRS** key on the keypad four times to enter "S".

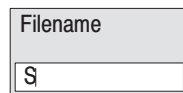

A rectangular box with a grey header labeled "Filename" and a white text input area below it. The character "S" is entered in the text input area.

3. Press the **ABC** key on the keypad once to enter "A".

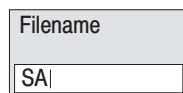

A rectangular box with a grey header labeled "Filename" and a white text input area below it. The characters "SA" are entered in the text input area.

4. Press the **MNO** key on the keypad once to enter "M".

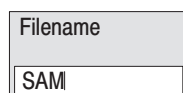

A rectangular box with a grey header labeled "Filename" and a white text input area below it. The characters "SAM" are entered in the text input area.

5. Enter the remaining characters in the same way.

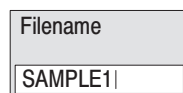

A rectangular box with a grey header labeled "Filename" and a white text input area below it. The characters "SAMPLE1" are entered in the text input area.

If you make a mistake, you can correct it any time before pressing the **Enter** side key by repeatedly pressing **BKSP** (the backspace key) until the incorrect character disappears and then typing the correct value. If you want to restart from the beginning, press the **Cancel - Back** (top) side key. You can also move the insertion cursor using the general purpose knob or up/down keys.

Deleting a File

You can delete a file using Windows, but not using the analyzer menu. Refer to page 3–179 for information about using Windows with the analyzer. Refer to Windows documentation for additional information about operating Windows.

Creating/Deleting a Directory

You can create or delete a directory using Windows, but not using the analyzer menu. Refer to page 3–179 for information about using Windows with the analyzer. Refer to Windows documentation for additional information about operating Windows.

File Format

This section describes the structure of the data file (*.IQT) and the trace file (*.TRC).

Data File Format

File Structure The data file normally consists of three blocks. You can add the date and time to the end for data logging (see Figure 3–109).

Data file (*.IQT)

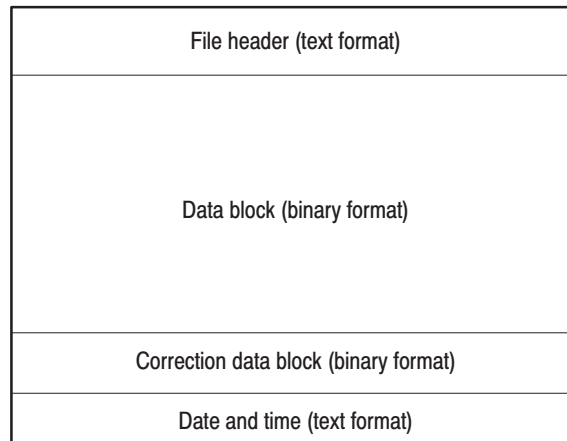

Figure 3–109: Data file structure

The file is normally created after data acquisition is complete. When logging data is acquired continuously, a data block is added each time the data is acquired.

In data logging, since the internal program adds data blocks while acquiring data, when the program creates the file header, the date and time for the last frame is not known. The program, therefore, adds date and time data to the end of the file. If you examine the file size and find the date and time at the end, use them in place of DateTime in the file header. Refer to DateTime on page 3–167 for the format of date and time.

The number of frames ValidFrames (refer to page 3–166) is not known at the time the program creates the file header, so the internal program temporarily writes ValidFrames=0. If the value of ValidFrames of the file header is 0, examine the file size and calculate the true value of ValidFrames. In this case, the correction data block is always added.

Details about each block are explained on the following pages.

File Header

The following is an example of the file header. Although Type is always written at the beginning, the order of the other items is not fixed and some new items may be added.

```
40416Type=WCA380IQT (NOTE: not WCA280AIQT but WCA380IQT)
FrameReverse=Off
FramePadding=Before
Band=RF3
MemoryMode=Zoom
FFTPoints=1024
Bins=801
MaxInputLevel=0
LevelOffset=0
CenterFrequency=7.9G
FrequencyOffset=0
Span=5M
BlockSize=40
ValidFrames=40
FramePeriod=160u
UnitPeriod=160u
FrameLength=160u
DateTime=2002/05/10@13:21:16
GainOffset=-82.3326910626668
MultiFrames=1
MultiAddr=0
IOffset=-0.0475921630859375
QOffset=0.12628173828125
```

The first character “4” indicates that the number of bytes of the file header is expressed with four characters after the second character.

In the preceding example:

Number of bytes of the file header = 1 + 4 + 0416 = 421

The number of bytes is therefore 421. Data starts from the 422nd byte.

Type. Shows the type of data. In the WCA200A series, only this type is used:

- **WCA380IQT.** The data block contains I and Q values in the time domain.

This type is called WCA380IQT for compatibility with the *.IQT file of the WCA300 series.

FrameReverse. Shows the frame order. This item is always Off in the WCA200A series. The following parameters are provided:

- **Off.** Frames are stored in the order of acquisition. The last frame in the data block is the latest acquired frame.
- **On.** Frames are stored in the reverse order of acquisition. The first frame in the data block is the latest acquired frame.

FramePadding. The analyzer adds dummy frames when acquired frames do not fill BlockSize (block size). Figure 3–110 shows the dummy frames. The FramePadding parameter is always set to Before in the WCA200A series.

- **Before.** Adds dummy frames before valid frames, but not in the first block.
- **After.** Adds dummy frames after valid frames, but not in the last block.

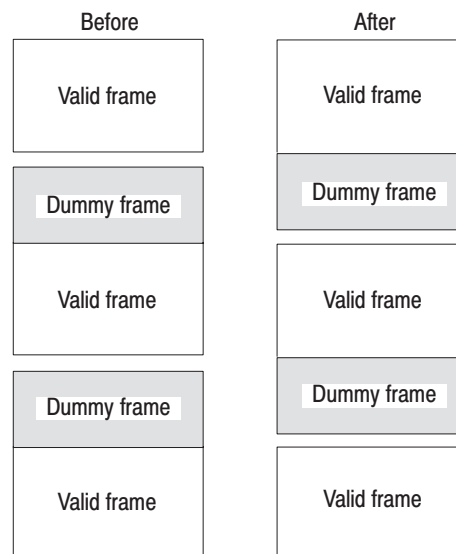

Figure 3–110: Adding dummy frames

Band. Shows the frequency band that was set when the analyzer acquired the data. It is necessary only when the analyzer reloads the data.

MemoryMode. Shows the memory mode that was set when the analyzer acquired the data. It is necessary only when the analyzer reloads the data.

FFTPoints. Shows the FFT point setting that was set when the analyzer acquired the data. This item is always 1024 in the WCA200A series.

Bins. Shows the number of bins. The same value is also entered in *bins* of each frame header of the data block (refer to *Frame Header* on page 3–168).

MaxInputLevel. Shows the reference level setting in dBm when the analyzer acquired the data.

LevelOffset. Shows the level offset setting in dB when the analyzer acquired the data.

CenterFrequency. Shows the center frequency setting in Hz when the analyzer acquired the data.

FrequencyOffset. Shows the frequency offset setting in Hz when the analyzer acquired the data.

Span. Shows the span setting in Hz when the analyzer acquired the data.

BlockSize. Shows the block size setting when the analyzer acquired the data.

ValidFrames. Shows the number of frames in the data block. This value divided by MultiFrames represents the number of frames that are scanned and synthesized into one frame.

FramePeriod. Shows the frame period setting in seconds. The actual period is obtained by multiplying UnitPeriod (described below) by the difference of time stamp ticks of each frame in the data block.

UnitPeriod. Shows the unit time in seconds of time stamp Ticks of each frame in the data block.

FrameLength. Shows the time in second necessary to acquire one frame.

DateTime. Shows the time when the analyzer acquired the last frame in a data block. Change “@” to “ ” (space) for display because files may have many “@” characters.

GainOffset. Shows the gain offset. It is used for calculating the amplitude (refer to page 3–169).

MultiFrames. Shows the number of frames in multi-frame mode. For example, when MultiFrames = 20, scanning 20 times with a span of 5 MHz makes a span of 100 MHz.

MultiAddr. Shows the last frame address in the multi-frame mode. The range is 0 to MultiFrames –1. MultiFrames –1 indicates that the data ends just at the end of scans.

IOffset. Shows the offset value of I data. It is used for calculating the data value (refer to page 3–169).

QOffset. Shows the offset value of Q data. It is used for calculating the data value (refer to page 3–169).

Data Block

Each data block contains several pairs of frame header and frame data (see Figure 3–111). The number of pairs in a block is indicated by ValidFrames in the file header. The frame order is determined by FrameReverse in the file header.

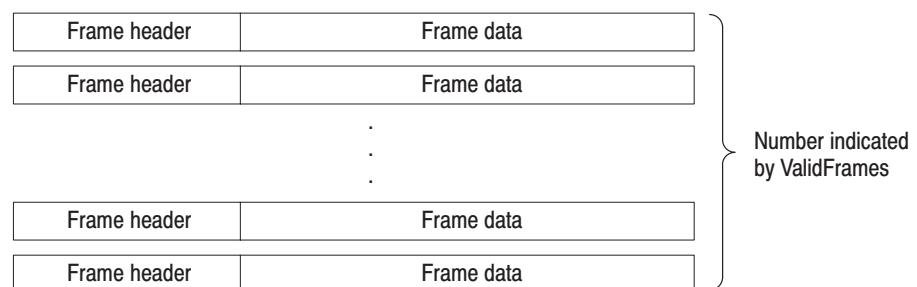

Figure 3–111: Data block

Frame Header The frame header is defined by the following structure:

```
struct frameHeader_st {
    short reserved1;
    short validA;
    short validP;
    short validI;
    short validQ;
    short bins;
    short reserved2;
    short triggered;
    short overLoad;
    short lastFrame;
    unsigned long ticks;
};
```

short reserved1. Internal use only.

short validA, validP, validI, validQ. These parameters indicate whether data of amplitude, phase, I or Q (value converted into a two-byte signed integer) is written.

- **0.** Indicates that data is not written in the file.
- **-1.** Indicates that data is written in the file.

There are seven combinations as listed in Table 3–24.

Table 3–24: Combinations of validA, P, I and Q

validA	validP	validI	validQ
0	0	0	0
-1	0	0	0
0	-1	0	0
-1	-1	0	0
0	0	-1	0
0	0	0	-1
0	0	-1	-1

short bins. Shows the number of bins. It is the same as Bins in the file header.

short reserved2. Internal use only.

short triggered. Indicates whether the frame is before or after the trigger.

- **0.** Indicates that the frame is before the trigger (pre-trigger).
- **-1.** Indicates that the frame is after the trigger (post-trigger).

short overLoad. Indicates whether an input overload occurred.

- **0.** Indicates that the MaxInputLevel value in the file header was correct.
- **-1.** Indicates that the MaxInputLevel value in the file header was too low.

short lastFrame. The analyzer can divide its memory into (100 frames) × (40 blocks), for example. LastFrame indicates the last frame in a block.

- **0.** Indicates that the frame is not the last in the block.
- **-1.** Indicates that the frame is the last in the block.

unsigned long ticks. Shows a time stamp using UnitPeriod in the file header (not FramePeriod) as a unit time.

Frame Data A frame contains 1024 pairs of I and Q data in the time domain in order of data acquisition.

Definition of Bin. The bin is defined by the following structure:

```
struct iqBin_st {
    short q;
    short i;
};
```

Definition of Frame. The frame is defined by the following structure:

```
struct iqFrame1024_st {
    struct iqBin_st iq[1024];
};
```

Calculation of Data All the data of amplitude, phase, I and Q are transformed to 2-byte signed integers, and then written in the file.

Amplitude. The amplitude is calculated using i and q in the IQT file using these formulas:

$$\begin{aligned}i &= i - \text{IOffset} \\q &= q - \text{QOffset} \\ \text{Amplitude} &= 10 * \ln(i * i + q * q) / \ln(10) \\ &\quad + \text{GainOffset} + \text{MaxInputLevel} + \text{LevelOffset} \text{ [dBm]}\end{aligned}$$

Phase. The phase is calculated using i and q in the IQT file using these formulas:

$$\begin{aligned}i &= i - \text{IOffset} \\q &= q - \text{QOffset} \\ \text{Phase} &= \text{atan2}(q, i) * (180 / \text{Pi}) \text{ [degree]}\end{aligned}$$

I, Q. I and Q are calculated using i and q in the IQT file using these formulas.

$$\begin{aligned}i &= i - \text{IOffset} \\q &= q - \text{QOffset} \\ \text{IQScale} &= \text{Sqrt}(\text{Power}(10, (\text{GainOffset} + \text{MaxInputLevel} \\ &\quad + \text{LevelOffset}) / 10) / 20 * 2) \\ I &= i * \text{IQScale} \text{ [V]} \\ Q &= q * \text{IQScale} \text{ [V]}\end{aligned}$$

Correction Data Block

The correction data block contains gain and phase correction data as one frame of data block in the frequency domain. When this block is added, the amplitude and phase are calculated using the following formulas. Be careful about the sign for phase correction.

$$\begin{aligned}\text{Amplitude} &= (\text{Original data}) - (\text{Gain correction data}/128) \text{ [dBm]} \\ \text{Phase} &= (\text{Original data}) + (\text{Phase correction data}/128) \text{ [degree]}\end{aligned}$$

Definition of Bin. The bin is defined by the following structure:

```
struct apBin_st {
    short a;
    short p;
};
```

Definition of Frame. The frame is defined by the following structure:

```
struct apFrame1024_st {
    struct apBin_st ap[1024];
};
```

Trace File Format

File Structure The trace file consists of two blocks in the text format. Figure 3–112 shows the structure and Figure 3–113 shows an example of a trace file.

Trace file (*.TRC)

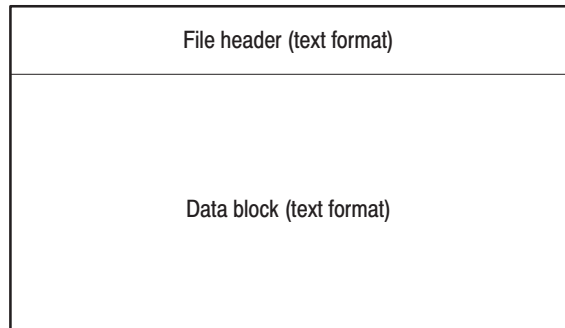

Figure 3–112: Trace file structure

```
# XNum=641
# XRightLabel=Span
# XStart=1.9995G
# XScale=1.0015625M
# XUnit=Hz
# ZNum=1
# YStart=-100
# XLeftLabel=Center
# UpdateAreas=1
# YUnit=dBm
# NBW=3.13180146596413k
# YMiddleUnit=dB
# YScale=100
# UpdatePosition=640
-100.875531204 0
-111.253515034 0
-101.342080442 0
-96.7588947616 0
-98.5946571418 0
-101.68696219 0
-97.8503895777 0
-100.806522438 0
-100.274828469 0
-95.8906131833 0
-97.9340093534 0
-101.366985559 0
...
```

The text is annotated with curly braces on the right side. The first brace, labeled 'File header', groups the lines from '# XNum=641' to '# UpdatePosition=640'. The second brace, labeled 'Data block', groups the lines from '-100.875531204 0' to '-101.366985559 0'.

Figure 3–113: Trace file example

File Header

The following is an example of the file header:

```
# XNum=641
# XRightLabel=Span
# XStart=1.9995G
# XScale=1.0015625M
# XUnit=Hz
# ZNum=1
# YStart=-100
# XLeftLabel=Center
# UpdateAreas=1
# YUnit=dBm
# NBW=3.13180146596413k
# YMiddleUnit=dB
# YScale=100
# UpdatePosition=640
```

Each item is explained below.

“*Required*” means that the item is prerequisite for displaying waveform.

XNum. *Required.* Represents the number of data in the data block.

XRightLabel. Represents the label displayed on the right of the horizontal axis:
Span (span) when XLeftLabel is Center (center frequency), or
Stop (stop frequency) when XLeftLabel is Start (start frequency).

XStart. *Required.* Represents the minimum (left) edge of the horizontal axis.

XScale. *Required.* Represents the scale of the horizontal axis.

XUnit. Represents the unit of the horizontal axis: fixed to Hz.

ZNum. *Required.* Internal use only: fixed to 1.

YStart. *Required.* Represents the minimum (bottom) edge of the vertical axis.

XLeftLabel. Represents the label on the left of the horizontal axis:
Center (center frequency) when XLeftLabel is Span (span), or
Start (start frequency) when XLeftLabel is Stop (stop frequency).

UpdateAreas. Internal use only.

YUnit. Represents the unit of the vertical axis: dBm, dB μ V, V, or W.

NBW. Specifies NBW (Noise Bandwidth) when setting FFT parameters, or RBW (Resolution Bandwidth) when setting RBW parameters.

YMiddleUnit. Represents the unit of the vertical axis scale. Specify dB when YUnit is dBm. For all other values of YUnit, the YUnit value is used.

YScale. *Required.* Represents the scale of the vertical axis.

UpdatePosition. Internal use only.

Data Block Pairs of a power value and a mask value are written in order, with a tab between the power and the mask (see Figure 3–114). The number of lines is indicated by XNum in the file header.

Power 1	(tab)	Mask 1	}	Number indicated by XNum
Power 2	(tab)	Mask 2		
Power 3	(tab)	Mask 3		
.				
.				
Power N	(tab)	Mask N		

Figure 3–114: Data block

Part of the data block might look like this:

–100.875531204	0
–111.253515034	0
–101.342080442	0
–96.7588947616	0
–98.5946571418	0
...	

For example, the first line indicates that the power is –100.875531204 dBm and the mask value is 0.

Mask Value. The mask value represents whether to display the data.

- **0.** Indicates that the data is displayed.
- **–1.** Indicates that the data is not displayed.

Connecting to LAN

The analyzer is equipped with the standard LAN Ethernet interface. You can share resources such as files or disks by connecting the analyzer to your network.

You can also control the analyzer from other PC via LAN. Refer to Programmer Manual for more details on remote control.

Attaching a Cable

Figure 3–115 shows the location of connectors on the side panel. The Ethernet 10/100BASE-T connector is located at the bottom. Attach a twisted-pair cable to the connector.

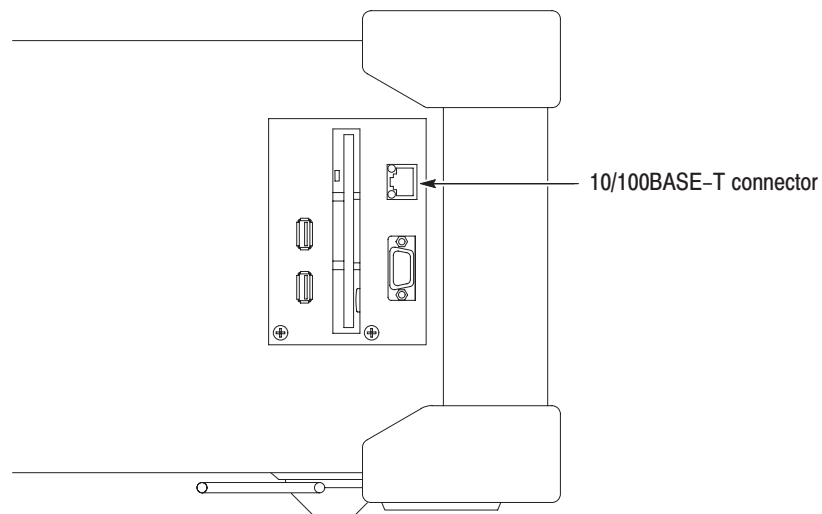

Figure 3–115: 10/100BASE-T connector (side panel)

If you reboot the analyzer after connecting to LAN, the analyzer recognizes the network speed automatically and sets it to 10 Mbps or 100 Mbps.

Network Settings

NOTE. *The network settings are not done when the instrument is shipped from the factory.*

You can use the Network dialog box in the Windows 98 Control Panel to set network parameters. You must set network parameters, such as an IP address, as appropriate to your operating environment. Contact your system administrator for information about setting these parameters. Refer to page 3–179 for operating Windows 98.

Sharing Resources

If the analyzer is connected to LAN, you can share resources such as files and disks on the network. To share resources, open the Properties dialog box for each resource such as files and disks, and enter required information on the Sharing tab. Figure 3–116 shows a setting example for sharing a folder.

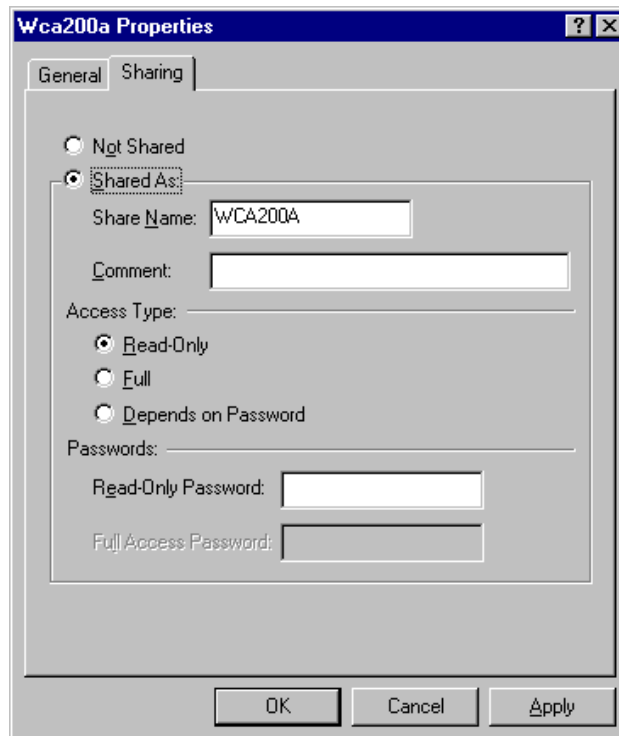

Figure 3–116: Sharing settings dialog box

Connecting USB Devices

The analyzer has two USB ports, which can accommodate the standard accessory mouse and keyboard, and other USB devices such as printers. The analyzer USB interface provides you with the following capabilities:

- Perform 12 Mbps high-speed data communication.
- Connect the USB device any time with no setup (plug & play).
- Connect and disconnect the USB device without needing to power off the analyzer (hot plug).
- Reboot the analyzer without needing to power off.

Figure 3–117 shows the location of the two USB ports on the analyzer side panel. You can connect a USB device to either or both ports.

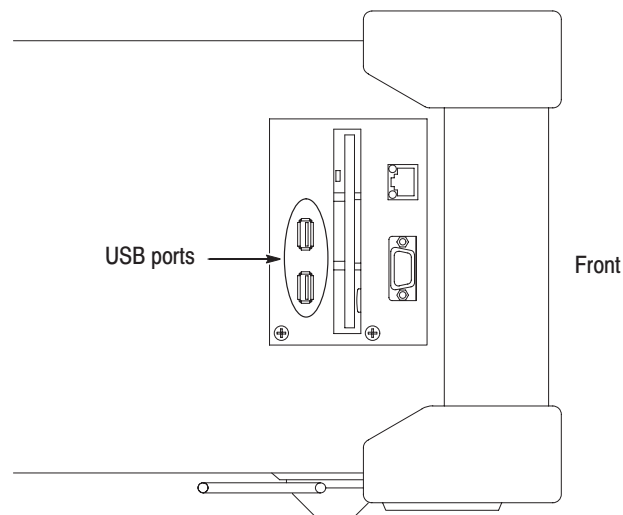

Figure 3–117: USB ports (side panel)

If you connect a mouse, keyboard, and printer, connect the mouse to the USB port on the keyboard (see Figure 3–118).

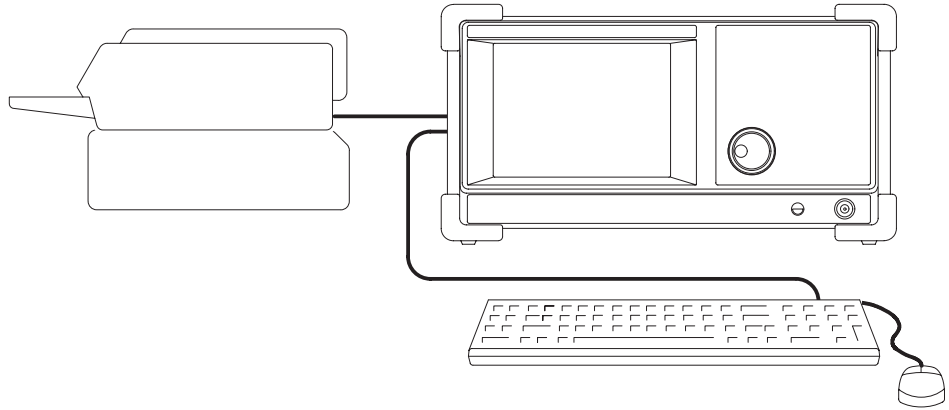

Figure 3–118: Connecting USB devices

For information about using the mouse and keyboard to operate the analyzer, see page 2–5.

Using Windows 98

This analyzer operates under Windows 98. You can switch to a Windows 98 desktop screen or execute a Windows 98 application program.

Connecting a Mouse and Keyboard

You must connect a mouse to the analyzer before you can access Windows 98. You can also connect a keyboard. Refer to *Connecting USB Devices* on page 3–177 for information about connecting these items. Refer to page 2–5 for information about using the mouse and keyboard.

When you power on the analyzer after attaching a mouse (and a keyboard), a pointer appears on the screen. You can start a Windows 98 application or switch to a Windows 98 desktop screen as you desire.

Starting Windows 98 Applications

When you use a mouse to move the pointer to the bottom of screen, a task bar appears (see Figure 3–119). The task bar contains Start and the analyzer application icons. Follow the Windows 98 operating procedure and access Windows applications using the Start menu.

Setting Date and Time

The screen displays the date and time managed by the Windows operating system. You can use the Windows 98 time setting program to set date and time.

Displaying the Windows Desktop Screen

To display a Windows desktop screen, follow these steps:

1. Use a mouse to move the pointer to the bottom of screen (see Figure 3–119). The task bar appears.
2. Locate the pointer on the **WCA230A** or **WCA280A** icon in the task bar and right-click. A menu appears.
3. Select **Close** from the menu. The system program of the analyzer terminates and the Windows 98 desktop screen appears.

Switching from Windows 98 to the Analyzer View

To switch from the Windows desktop screen to the analyzer display, from the task bar, select **Start** → **Program** → **WCA200A**. The analyzer program starts.

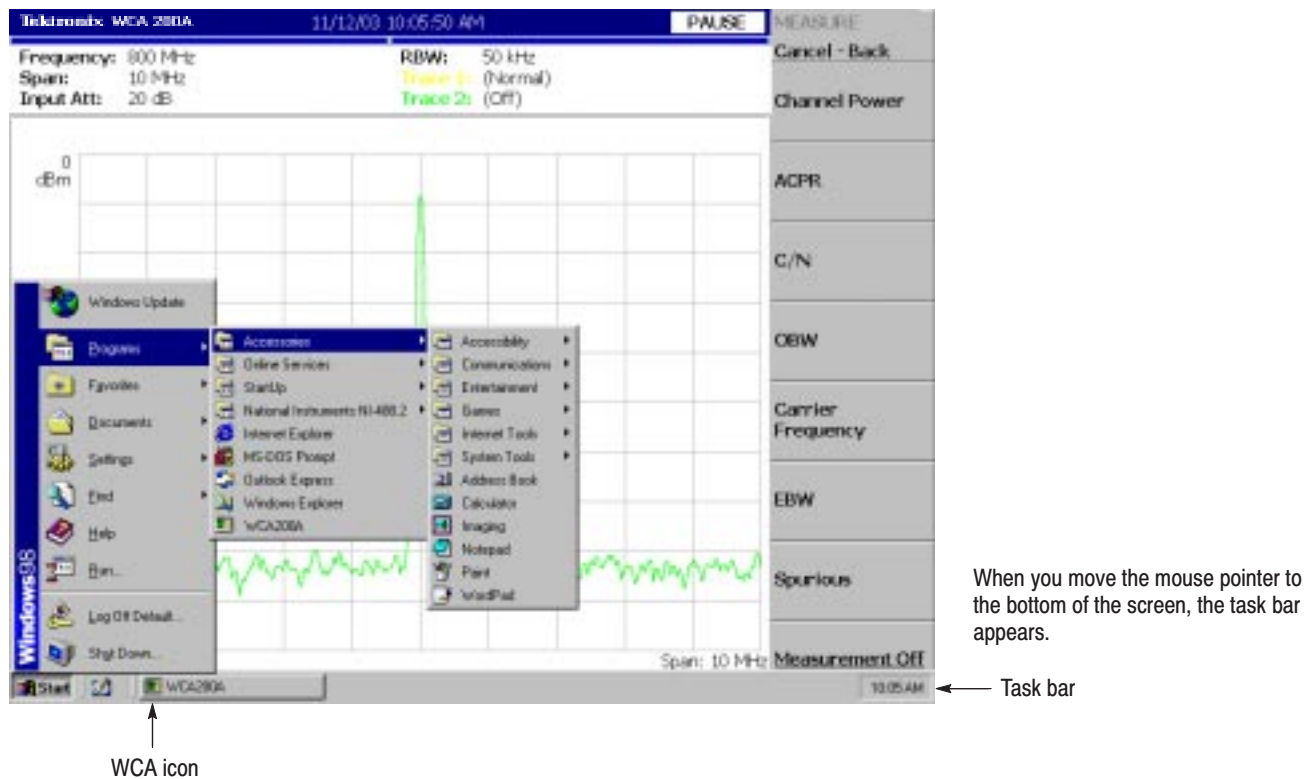

Figure 3-119: Displaying the Windows 98 accessory menu

Screen Copy

This section explains the method for sending a screen copy to a printer or a file. Use a printer that complies with USB specifications. For files, data in the bitmap format (.BMP) are created. The following items are described in this section:

- Print Menu
- Printing
- Creating a File

Print Menu

Press the **PRINT** key in the Utility section to invoke the Print menu.

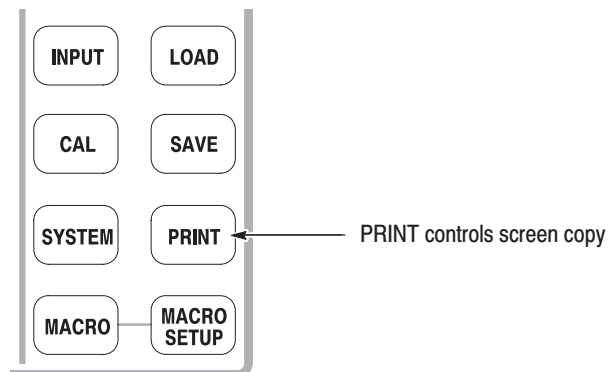

The Print menu contains the following items:

- **Print now.** Starts printing a copy of the analyzer screen to an attached printer.
- **Save screen to file...** Invokes the Save menu to save a bitmap file. For file operations, refer to page 3–153.
- **Background color.** Selects the background color for printing.
 - **Black** prints the background of screen in black.
 - **White** Reverses the background of screen to white.
- **Printer...** Selects a destination printer.

Printing a Screen Copy

You must connect the USB printer to the analyzer and install the printer driver before you can print.

Connecting a Printer

Connect the USB cable of the printer to the USB port on the side panel of the analyzer (see Figure 3–120). You can use either of two ports. Refer to page 3–177 for connecting USB devices.

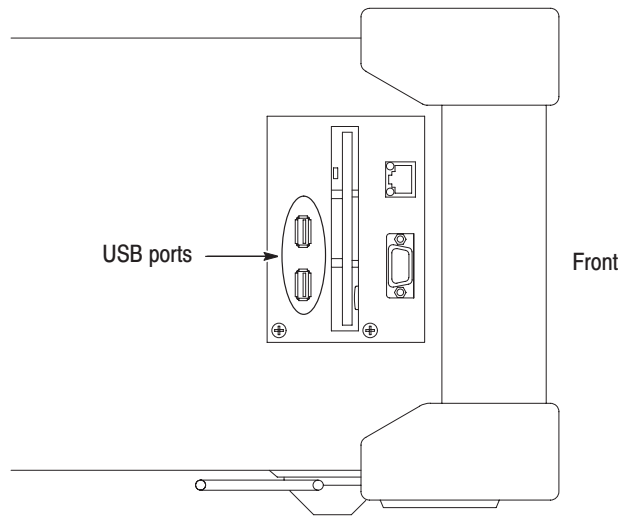

Figure 3–120: USB ports (side panel)

If the analyzer is connected to a network through a LAN interface, you can also use a network printer.

Installing Printer Driver

Install the printer driver using the Windows 98 printer wizard. Refer to the printer manual for the installation method. Refer to page 3–179 for using Windows 98.

Print To print a copy of the analyzer screen, follow these steps:

1. Press the **PRINT** key on the front panel, and select **Black** or **White** of the background color with the **Background color** side key (see Figure 3–121).

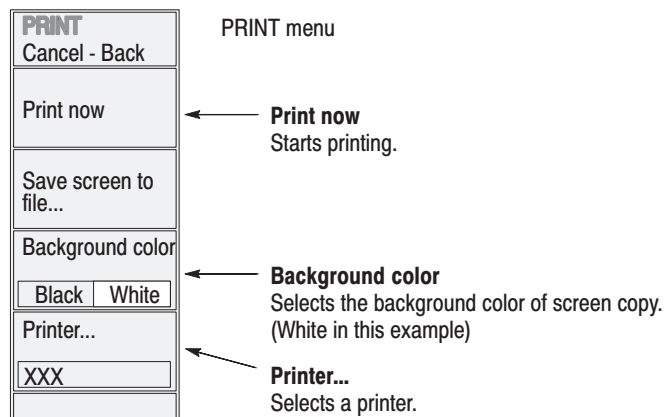

Figure 3–121: Print command

2. Display the measurement to be printed and stop data acquisition.
3. Press the **PRINT** key again. The screen image data is captured on the internal memory with the background color set in step 1.
4. Press the **Printer...** side key and select a destination printer.
5. Press the **Print now** side key to start printing.

If the printer driver displays a message during printing, follow the instructions.

Creating a File

You can save a screen image to a file as bitmap data and read the data into a word processor to create a report, for example.

If you save the file to a floppy disk, insert it to the floppy disk drive.

1. Press the **PRINT** key on the front panel, and select **Black** or **White** of the background color with the **Background color** side key (see Figure 3–122).

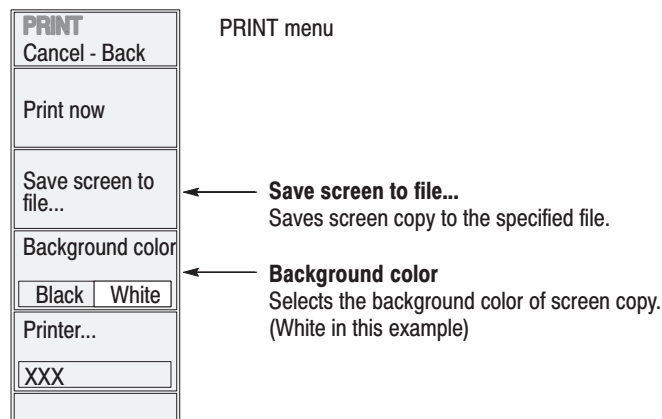

Figure 3–122: Save screen to file

2. Display the measurement to be copied and stop data acquisition.
3. Press the **PRINT** key again. The screen image data is captured on the internal memory with the background color set in step 1.
4. Press the **Save screen to file...** side key. The file selection screen appears.
5. Do one of the following to output the screen image to a specified file:
 - *Using a preset file name:* Press the **Save to BitmapA**, **Save to BitmapB**, or **Save to BitmapC** side key. The image data is stored to the file *BitmapA.bmp*, *BitmapB.bmp*, or *BitmapC.bmp* in the *C:\My Documents* folder, respectively.
 - *Entering a new file name:* Enter a file name with the **Filename** side key, referring to *Entering a File Name* on page 3–160. The file extension *.BMP* is automatically assigned. When you have finished entering the name, press the **Save File Now** side key to store the copy in the file.

After the screen copy is saved in the file, the screen returns to the original waveform display.

Using the Online Help

This section describes the analyzer help system and how to access it.

The online help system is integrated as part of the analyzer user interface, using the Windows help system. You can use the front-panel arrow keys (as in the following procedure), a mouse, or a keyboard to navigate through the help system. See page 3–188 for information about using a mouse or keyboard to navigate through the online help.

The help system provides information about operating this analyzer, providing the following help resources online:

- Front-panel key descriptions
- Online user manual
- Online programmer manual

Displaying the Online Help

Use the following procedure to show the online help:

1. Press the **HELP** key on the front panel.

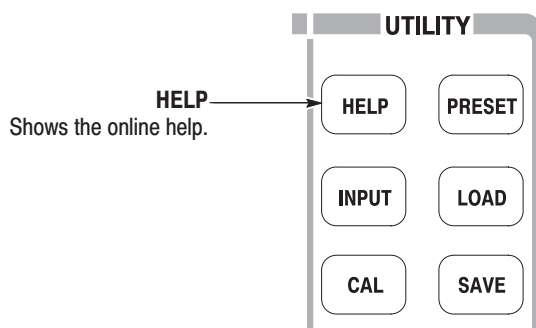

2. Select the type of online help using the side keys:
 - **View Front Panel Button Help.** Provides descriptions of the front-panel keys.
 - **View Online User Manual.** Displays the analyzer user manual, formatted for online use.
 - **View Online Programmer Manual.** Displays the analyzer programmer manual, formatted for online use.

3. Depending on the type of online manual you selected, do one of the following two procedures:
 - a. If you selected *View Front Panel Button Help*: Press the front-panel key about which you want to receive information. For example, press the **MEASURE** key to show information about that key (see Figure 3–123).

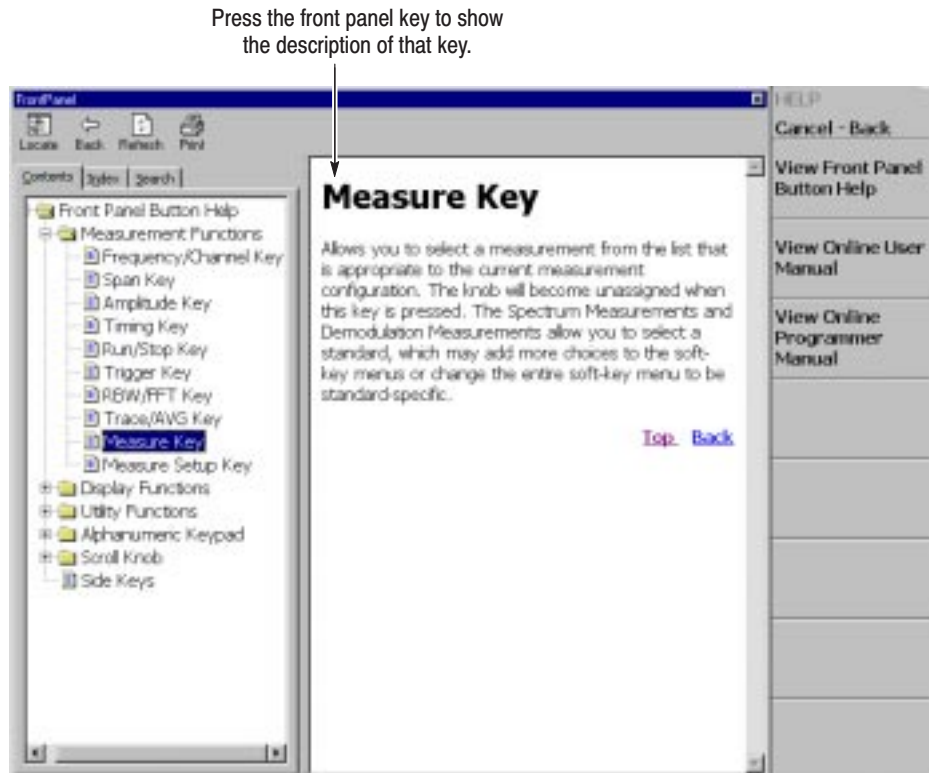

Figure 3–123: Online help for the front panel key

- b. If you selected *View Online User Manual* or *View Online Programmer Manual*: Using the front panel keys listed in Table 3–25, select the topic from the contents window on screen (see Figure 3–124). The key functions are different between the contents (left) window and the descriptions (right) window.

Table 3–25: Front panel keys for online help

Front panel key	Function	
	Contents window	Descriptions window
General purpose knob	Selects a topic.	Scrolls the display up or down.
Up key (▲)	Selects a topic on top in the window.	Scrolls the display up.

Table 3-25: Front panel keys for online help (Cont.)

Front panel key	Contents window	Descriptions window
Down key (▼)	Selects a topic on bottom in the window.	Scrolls the display down.
MARKERS: ▲	Selects the next upper topic.	Scrolls the display up.
MARKERS: ▼	Selects the next lower topic.	Scrolls the display down.
MARKERS: ◀	Moves to the next upper hierarchy.	Scrolls the display to the left.
MARKERS: ▶	Moves to the next lower hierarchy.	Scrolls the display to the right.
PEAK	Switch the window to operate the cursor.	
MARKER ➔	-	Selects a character string with hyperlink.
BKSP	Moves to the next upper hierarchy.	Returns to the previous display.
ENTER	Accepts the selection and displays the corresponding content.	

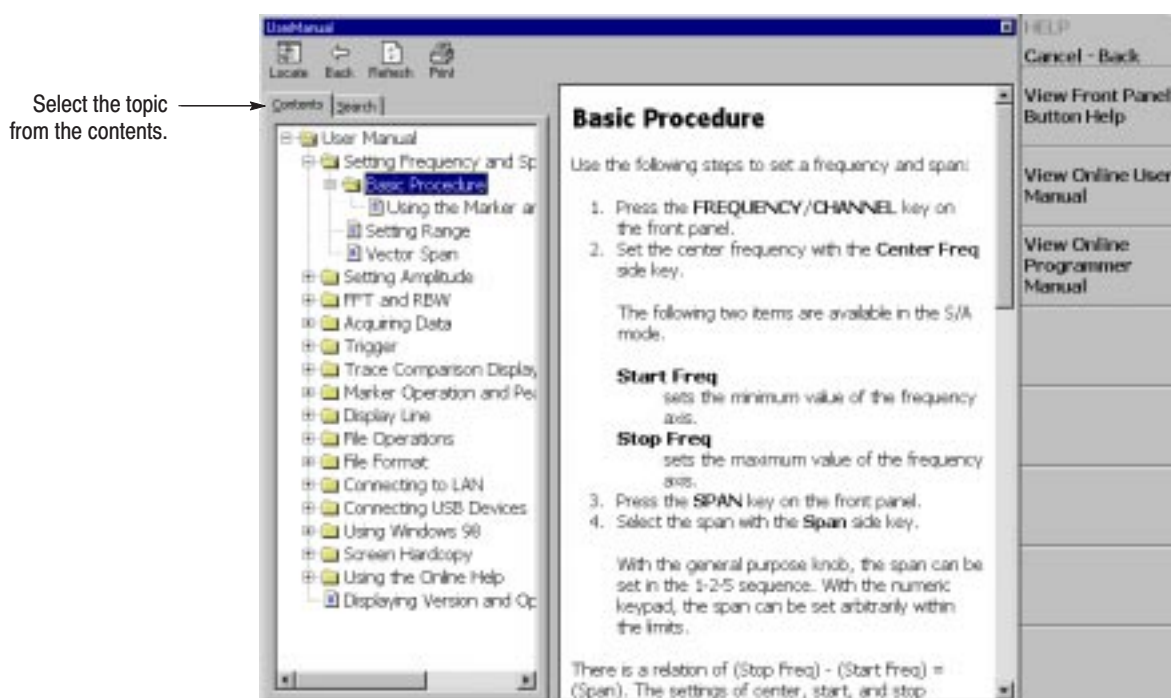

Figure 3-124: Online user manual

4. To exit the help system, press the **Cancel-Back** (top) side key.

Using a Mouse and Keyboard

You can control the help system using a mouse and a keyboard instead of the front panel keys. Using a mouse, click the topic in the contents window to show the description. Using a keyboard, select a topic or enter a search word (see Figure 3–125). Use the arrow keys to move the cursor, and the enter key to accept the selection.

Refer to *Connecting USB Devices* on page 3–177 on connecting a mouse and a keyboard to the analyzer.

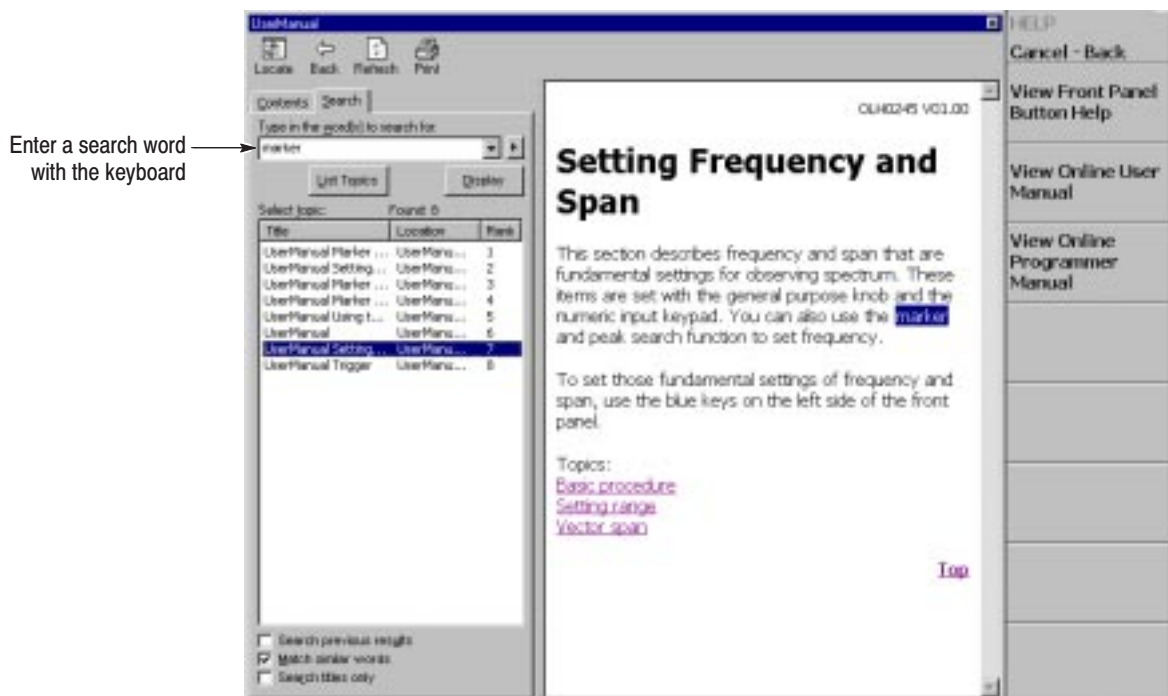
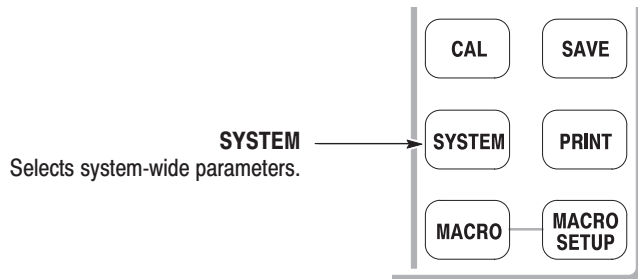

Figure 3–125: Word search using the keyboard

Displaying the Version and Options

You can see the version and optional information.

1. Press the **SYSTEM** key on the front panel.



2. Press the **Versions and Installed Options...** side key. The screen appears as shown in Figure 3–126.

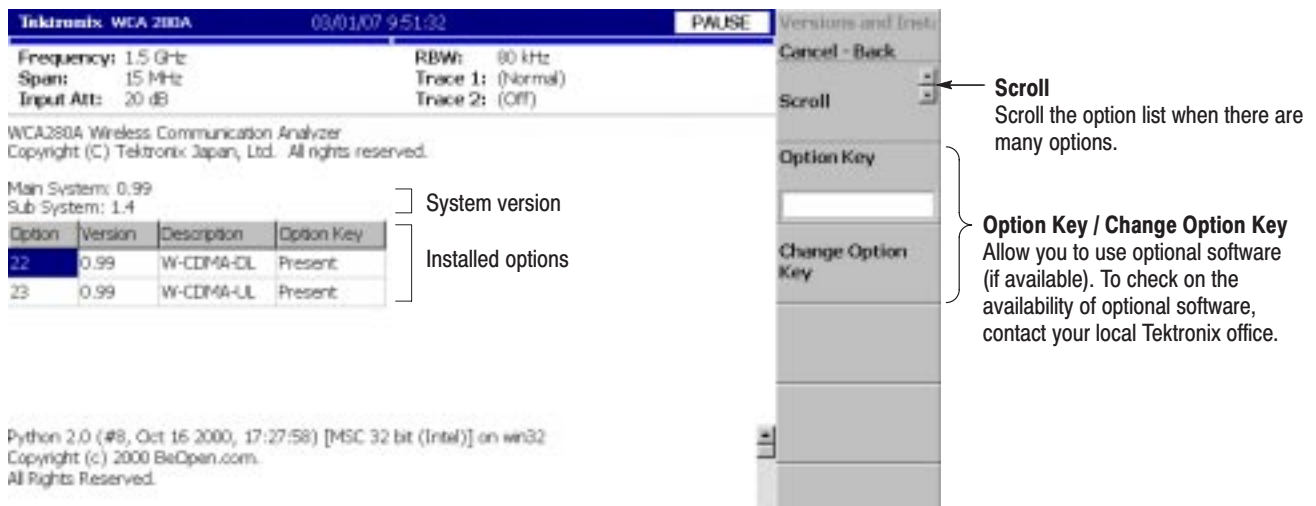

Figure 3–126: Displaying versions and options

The following information is shown on the screen:

- **Version**

- Main System: Basic application software version
- Sub System: Firmware version

- **Option**

The table shows version and name of the optional software installed. The “Option Key” field tells you the following information:

- Present: Indicates you can use the optional software.
- Not Present: Indicates you cannot use the optional software. For information about how to remove the protection and use the software, refer to *Enabling the Optional Software*.

3. To exit the version display, press any front-panel key.

Enabling the Optional Software.

1. Contact your local Tektronix office to order the software. You will receive an option key (alphanumeric code).
2. Press the **Option Key** side key (see Figure 3–126) and enter the option key using the alphanumeric keypad on the front panel.

NOTE. When you input “–” (hyphen), press the “.” (period) key until the hyphen appears.

3. Press the **Change Option Key** side key to accept the input.

Now you can use the software on the analyzer.

Appendices

Appendix A: Specifications

This appendix lists the electrical, physical, and environmental characteristics of the analyzer, and specifies the performance requirements for those characteristics. The specifications are common to WCA230A and WCA280A, unless otherwise noted.

Unless otherwise stated, the following tables of electrical characteristics and features apply to the analyzer after a 20 minute warm-up period (within the environmental limits) and after all calibration procedures have been carried out.

Electrical Characteristics

Table A-1: Frequency

Characteristics	Description
Measurement frequency	
Frequency range	Baseband: DC to 20 MHz RF: 15 MHz to 3 GHz (WCA230A) RF1: 15 MHz to 3.5 GHz (WCA280A) RF2: 3.5 GHz to 6.5 GHz (WCA280A) RF3: 5 GHz to 8 GHz (WCA280A)
Center frequency setting resolution	0.1 Hz
Frequency marker readout accuracy	Baseband: $\pm(RE \times MF + 0.001 \times \text{Span} + 0.2)$ Hz RF, RF1 to 3: $\pm(RE \times MF + 0.001 \times \text{Span} + 2)$ Hz RE: Reference frequency error; MF: Marker frequency [Hz]
At specified frequency	Baseband, Frequency = 10 MHz, Span = 1 MHz Marker: ± 1 kHz; Carrier frequency measurement: ± 1.2 Hz RF/RF1, Frequency = 2 GHz, Span = 1 MHz Marker: ± 1.2 kHz; Carrier frequency measurement: ± 210 Hz RF2, Frequency = 5 GHz, Span = 1 MHz (WCA280A only) Marker: ± 1.5 kHz; Carrier frequency measurement: ± 510 Hz RF3, Frequency = 7 GHz, Span = 1 MHz (WCA280A only) Marker: ± 1.7 kHz; Carrier frequency measurement: ± 710 Hz
Residual FM $2 f \times N$	2 Hz p-p
Span accuracy	0.1%
RBW filter bandwidth	0.1%

Table A-1: Frequency (Cont.)

Characteristics	Description
Reference frequency	
Aging per day	1×10^{-9} (after 30 days of operation)
Aging per year	1×10^{-7} (after 30 days of operation)
Temperature drift	1×10^{-7} (10 to 40 °C)
Total frequency error	2×10^{-7} (within one year after calibration)
Reference output level	>0 dBm
External reference input	10 MHz, -10 to +6 dBm

Table A-2: Spectrum purity

Characteristics	Description
Spectrum purity (Frequency = 1500 MHz)	
Carrier offset = 10 kHz, Span = 100 kHz	-100 dBc/Hz
Carrier offset = 100 kHz, Span = 1 MHz	-105 dBc/Hz
Carrier offset = 1 MHz, Span = 5 MHz	-125 dBc/Hz

Table A-3: Noise sideband

Characteristics	Description	
	Noise sideband	Offset
Frequency = 1000 MHz	-100 dBc/Hz	1 kHz
	-105 dBc/Hz	10 kHz
	-105 dBc/Hz	20 kHz
	-105 dBc/Hz	30 kHz
	-112 dBc/Hz	100 kHz
	-132 dBc/Hz	1 MHz
	-135 dBc/Hz	5 MHz
	-135 dBc/Hz	7 MHz
Frequency = 2000 MHz	-96 dBc/Hz	1 kHz
	-104 dBc/Hz	10 kHz
	-105 dBc/Hz	20 kHz
	-105 dBc/Hz	30 kHz
	-112 dBc/Hz	100 kHz
	-132 dBc/Hz	1 MHz
	-135 dBc/Hz	5 MHz
	-135 dBc/Hz	7 MHz

Table A-3: Noise sideband (Cont.)

Characteristics	Description	
Frequency = 6000 MHz (WCA280A only)	-87 dBc/Hz -104 dBc/Hz -105 dBc/Hz -105 dBc/Hz -112 dBc/Hz -128 dBc/Hz -130 dBc/Hz -130 dBc/Hz	1 kHz 10 kHz 20 kHz 30 kHz 100 kHz 1 MHz 5 MHz 7 MHz
	Noise sideband	Offset
Frequency = 1000 MHz	-103 dBc/Hz -108 dBc/Hz -108 dBc/Hz -108 dBc/Hz -115 dBc/Hz -135 dBc/Hz -138 dBc/Hz -138 dBc/Hz	1 kHz 10 kHz 20 kHz 30 kHz 100 kHz 1 MHz 5 MHz 7 MHz
Frequency = 2000 MHz	-99 dBc/Hz -107 dBc/Hz -108 dBc/Hz -108 dBc/Hz -115 dBc/Hz -135 dBc/Hz -138 dBc/Hz -138 dBc/Hz	1 kHz 10 kHz 20 kHz 30 kHz 100 kHz 1 MHz 5 MHz 7 MHz
Frequency = 6000 MHz (WCA280A only)	-90 dBc/Hz -107 dBc/Hz -108 dBc/Hz -108 dBc/Hz -115 dBc/Hz -131 dBc/Hz -133 dBc/Hz -133 dBc/Hz	1 kHz 10 kHz 20 kHz 30 kHz 100 kHz 1 MHz 5 MHz 7 MHz

Table A-4: Input

Characteristics	Description
Signal input	
Input connector	N type (RF and baseband input); BNC type (Option 03 IQ input)
Input impedance	50 Ω
VSWR	<1.4 (2.5 GHz, RF attenuation \geq 10 dB) <1.8 (7.5 GHz, RF attenuation \geq 10 dB, WCA280A only)
	<1.4 (300 kHz to 10 MHz, RF attenuation \geq 10 dB) <1.3 (10 MHz to 3 GHz, RF attenuation \geq 10 dB) <1.4 (3 GHz to 8 GHz, RF attenuation \geq 10 dB, WCA280A only)
Maximum input level	
Maximum DC voltage	\pm 0.2 V (RF, RF1 to 3) \pm 5 V (Baseband) \pm 5 V (Option 03 IQ input)
Maximum input power	+30 dBm (RF, RF1 to 3, RF attenuation \geq 10 dB)
Input attenuator	
RF/Baseband attenuator	0 to 50 dB (2 dB step in RF/RF1/Baseband; 10 dB step in RF2/RF3)
I/Q attenuator	0 to 30 dB (10 dB step)

Table A-5: Amplitude

Characteristics	Description
Reference level	
Reference level setting range	-30 to +20 dBm (2 dB step, Baseband) -51 to +30 dBm (1 dB step, RF/RF1) -50 to +30 dBm (1 dB step, RF2/RF3, WCA280A only) -10 to +20 dBm (10 dB step, Option 03 IQ input)
Accuracy (-10 to -50 dBm)	\pm 0.2 dB (at 50 MHz, 10 dB attenuation, 20 to 30 $^{\circ}$ C)
Frequency response (RF attenuation \geq 10 dB)	
at 20 to 30 $^{\circ}$ C	\pm 0.5 dB (Baseband) \pm 1.2 dB (RF/RF1) \pm 1.7 dB (RF2, WCA280A only) \pm 1.7 dB (RF3, WCA280A only)
	\pm 0.3 dB (100 kHz to 20 MHz) \pm 0.5 dB (10 MHz to 3 GHz) \pm 0.5 dB (10 MHz to 3.5 GHz, WCA280A only) \pm 1.0 dB (3.5 GHz to 6.5 GHz, WCA280A only) \pm 1.0 dB (5 GHz to 8 GHz, WCA280A only)
at 10 to 40 $^{\circ}$ C	\pm 0.7 dB (Baseband) \pm 1.5 dB (RF/RF1) \pm 2.0 dB (RF2, WCA280A only) \pm 2.0 dB (RF3, WCA280A only)

Table A-5: Amplitude (Cont.)

Characteristics	Description
Absolute amplitude accuracy at calibration point (0 dB attenuation, 20 to 30 °C)	±0.3 dB (Baseband at 10 MHz, -10 dBm signal) ±0.5 dB (50 MHz, -20 dBm signal)
Input attenuator setting uncertainty	±0.5 dB (at 50 MHz)
Level linearity in display range	±0.2 dB (0 to -40 dBfs) ±0.2 dB (0 to -50 dBfs, $2 f \gg N$) ±0.12 dB (0 to -50 dBfs, $2 f \approx N$)
Channel power measurement accuracy for W-CDMA signal at 20 to 30 °C $2 f \gg N$	±0.6 dB (Signal frequency: 1900 to 2200 MHz; Signal power: +10 to -30 dBm; RF attenuation: 0 to 20 dB; After Auto Level operation at 10 MHz span)

Table A-6: Dynamic range

Characteristics	Description
1 dB compression input	+2 dBm (RF attenuation = 0 dB, 2 GHz)
Second harmonic distortion (-30 dBm tone at input mixer)	-56 dBc (10 MHz to 1500 MHz) -56 dBc (10 MHz to 1750 MHz, WCA280A only)
3rd order intermodulation distortion (Reference level = +5 dBm , RF attenuation = 20 dB, Total signal power = -7 dBm)	
Center frequency = 2 GHz	-74 dBc
At 100 MHz to 3 GHz	-74 dBc
At 3 GHz to 8 GHz (WCA280A only)	-72 dBc
Displayed average noise level	-150 dBm/Hz at 10 MHz in baseband -150 dBm/Hz at 2 GHz -147 dBm/Hz at 3 GHz -141 dBm/Hz at 7 GHz (WCA280A only) -144 dBm/Hz (100 Hz to 10 kHz) -151 dBm/Hz (10 kHz to 10 MHz) -151 dBm/Hz (10 MHz to 100 MHz) -151 dBm/Hz (100 MHz to 1 GHz) -150 dBm/Hz (1 GHz to 2 GHz) -150 dBm/Hz (2 GHz to 3 GHz) -142 dBm/Hz (3 GHz to 5 GHz) -142 dBm/Hz (5 GHz to 8 GHz)
ACLR (3GPP down link, test model 1, 16 ch)	60 dB (5 MHz offset) 63 dB (10 MHz offset)
$2 f \gg N$	66 dB (5 MHz offset) 70 dB (10 MHz offset)
Local feed-through to input connector $2 f \gg N$	-40 dBm (local frequency 4.2 to 5 GHz) -55 dBm (local frequency 5 to 6 GHz) -60 dBm (local frequency 6 to 7 GHz) -60 dBm (local frequency 7 to 7.7 GHz, WCA280A only)

Table A-7: Spurious response

Characteristics	Description
Image Suppression $2f \pm N$	
1 st IF	75 dB (RF/RF1) 70 dB (RF2/RF3, WCA280A only)
2 nd and 3 rd IF	80 dB (RF/RF1) 75 dB (RF2/RF3, WCA280A only)
Alias suppression $2f \pm N$	
	65 dB (Baseband)
Residual response (Reference level = -30 dBm, RBW = 100 kHz)	
Baseband, 1 to 20 MHz	-93 dBm (Span = 20 MHz)
RF, 0.5 to 3 GHz (WCA280A)	-90 dBm (Span = 2.5 GHz)
RF1, 0.5 to 3.5 GHz (WCA280A)	-90 dBm (Span = 3 GHz)
RF2, 3.5 to 6.5 GHz (WCA280A)	-85 dBm (Span = 3 GHz)
RF3, 5 to 8 GHz (WCA280A)	-85 dBm (Span = 3 GHz)
Spurious response (Span = 10 MHz, Reference level = 0 dBm, RBW = 50 kHz)	
Baseband, 10 MHz	-73 dBc (Signal frequency = 10 MHz, Signal level = -5 dBm)
RF/RF1, 2 GHz	-73 dBc (Signal frequency = 2 GHz, Signal level = -5 dBm)
RF2, 5 GHz (WCA280A)	-70 dBc (Signal frequency = 5 GHz, Signal level = -5 dBm)
RF3, 7 GHz (WCA280A)	-70 dBc (Signal frequency = 7 GHz, Signal level = -5 dBm)

Table A-8: Acquisition

Characteristics	Description
Acquisition mode	Single and Continuous
Acquisition memory size	64 Mbytes (Standard); 256 Mbytes (Option 02)
Block size	1 to 16,000 frames (Standard); 1 to 64,000 frames (Option 02)
Number of data samples in one frame	1024 (Vector mode)
A/D converter	14 bits, 51.2 Msps
Real-time span	5 MHz (Option 02 only)
Vector span	15 MHz (RF, RF1 to 3), 20 MHz (Baseband), 20 MHz (Option 03 IQ input)
Real-time capture bandwidth	Baseband: 20 MHz; RF: 10 MHz; IQ: 10 MHz (Option 03 only)

Table A-9: Sampling rate

Characteristics	Description
Sampling rate (Real Time S/A, Demod, and Time modes)	
20 MHz span (Baseband)	25.6 Msps
15 MHz span (RF, RF1 to 3)	25.6 Msps
10 MHz span	12.8 Msps
5 MHz span	6.4 Msps
2 MHz span	3.2 Msps
1 MHz span	1.6 Msps
500 kHz span	800 ksps
200 kHz span	320 ksps
100 kHz span	160 ksps
50 kHz span	80 ksps
20 kHz span	32 ksps
10 kHz span	16 ksps
5 kHz span	8 ksps
2 kHz span	3.2 ksps
1 kHz span	1.6 ksps
500 Hz span	800 sps
200 Hz span	320 sps
100 Hz span	160 sps

Table A-10: Frame time

Characteristics	Description
Frame time (Real Time S/A, Demod, and Time modes)	
20 MHz span (Baseband)	40 μ s
15 MHz span (RF, RF1 to 3)	40 μ s
10 MHz span	80 μ s
5 MHz span	160 μ s
2 MHz span	320 μ s
1 MHz span	640 μ s
500 kHz span	1.28 ms
200 kHz span	3.2 ms
100 kHz span	6.4 ms
50 kHz span	12.8 ms
20 kHz span	32 ms
10 kHz span	64 ms
5 kHz span	128 ms
2 kHz span	320 ms
1 kHz span	640 ms
500 Hz span	1.28 s
200 Hz span	3.2 s
100 Hz span	6.4 s

Table A-11: Digital demodulation

Characteristics	Description
Demodulator	
Carrier type	Continuous and Burst
Modulation format	BPSK, QPSK, $\pi/4$ shift DQPSK, 8PSK, 16QAM, 64QAM, 256QAM, GMSK, and GFSK
Measurement filter	Root cosine
Reference filter	Cosine, Gauss
Filter parameter	α /BT: 0.0001 to 1, 0.0001 step
Maximum symbol rate	12.8 Msps
Standard setup	PDC, PHS, NADC, TETRA, GSM, CDPD, and Bluetooth

Table A-11: Digital demodulation (Cont.)

Characteristics	Description	
Display format		
Vector diagram	Symbol/Locus display, Frequency error measurement, and Origin offset measurement	
Constellation diagram	Symbol display, Frequency error measurement, and Origin offset measurement	
Eye diagram	I, Q, and Trellis displays (1 to 16 symbols)	
Error vector diagram	EVM, Magnitude error, Phase error, Waveform quality (ρ) measurement, Frequency error measurement, and Origin offset measurement	
Symbol table	Binary, Octal, Hexadecimal	
Accuracy		
PDC (100 kHz span)	EVM $\leq 1.2\%$, Magnitude error $\leq 1.0\%$, Phase error $\leq 0.8^\circ$	
PHS (1 MHz span)	EVM $\leq 1.4\%$, Magnitude error $\leq 1.2\%$, Phase error $\leq 0.8^\circ$	
GSM (1 MHz span)	EVM $\leq 1.8\%$, Magnitude error $\leq 1.2\%$, Phase error $\leq 1.0^\circ$	
64QAM, 5.3 Msps, 1 GHz carrier (15 MHz span,)	EVM $\leq 2.5\%$	
QPSK, 3.84 Msps, 2 GHz carrier (15 MHz span,)	EVM $\leq 2.5\%$	
QPSK	EVM	Symbol rate
Center frequency = 1 GHz	0.5%	100 kHz
	0.5%	1 MHz
	1.2%	4 MHz
	2.7%	10 MHz
Center frequency = 2 GHz	0.5%	100 kHz
	0.5%	1 MHz
	1.2%	4 MHz
	2.7%	10 MHz
Center frequency = 3 GHz	0.7%	100 kHz
	0.7%	1 MHz
	1.5%	4 MHz
	2.9%	10 MHz
Center frequency = 5 GHz (WCA280A only)	0.7%	100 kHz
	0.7%	1 MHz
	1.5%	4 MHz
	3.0%	10 MHz

Table A-11: Digital demodulation (Cont.)

Characteristics	Description	
$\pi/4$ DQPSK	EVM	Symbol rate
Center frequency = 1 GHz	0.6%	100 kHz
	0.6%	1 MHz
	1.2%	4 MHz
	2.7%	10 MHz
Center frequency = 2 GHz	0.6%	100 kHz
	0.6%	1 MHz
	1.2%	4 MHz
	2.7%	10 MHz
Center frequency = 3 GHz	0.7%	100 kHz
	0.7%	1 MHz
	1.5%	4 MHz
	2.9%	10 MHz
Center frequency = 5 GHz (WCA280A only)	0.7%	100 kHz
	0.7%	1 MHz
	1.5%	4 MHz
	3.0%	10 MHz
16QAM	EVM	Symbol rate
Center frequency = 1 GHz	0.9%	100 kHz
	0.5%	1 MHz
	1.2%	4 MHz
	2.2%	10 MHz
Center frequency = 2 GHz	0.9%	100 kHz
	0.5%	1 MHz
	1.2%	4 MHz
	2.2%	10 MHz
Center frequency = 3 GHz	0.9%	100 kHz
	0.5%	1 MHz
	1.2%	4 MHz
	2.5%	10 MHz
Center frequency = 5 GHz (WCA280A only)	0.9%	100 kHz
	0.5%	1 MHz
	1.2%	4 MHz
	2.5%	10 MHz

Table A-12: Analog demodulation

Characteristics	Description
Accuracy	
AM demodulation	$\pm 2\%$ (-10 dBfs input at center, 10 to 60% modulation depth)
PM demodulation	$\pm 3^\circ$ (-10 dBfs input at center)
FM demodulation	$\pm 1\%$ of span (-10 dBfs input at center)

Table A-13: RBW (Resolution Bandwidth)

Characteristics	Description
Filter shape	Gaussian, Rectangle, Root Nyquist
Setting range	1 Hz to 10 MHz
Minimum Resolution Bandwidth (S/A mode)	
>2 GHz span	100 kHz
1 to 1.99 GHz span	50 kHz
500 to 990 MHz span	20 kHz
200 to 490 MHz span	10 kHz
100 to 190 MHz span	10 kHz
50 to 90 MHz span	10 kHz
20 to 40 MHz span	10 kHz
10 MHz span	1 kHz
5 MHz span	1 kHz
2 MHz span	1 kHz
1 MHz span	1 kHz
500 kHz span	500 Hz
200 kHz span	200 Hz
100 kHz span	100 Hz
50 kHz span	50 Hz
20 kHz span	20 Hz
10 kHz span	10 Hz
5 kHz span	5 Hz
2 kHz span	2 Hz
1 kHz span	1 Hz
500 Hz span	1 Hz
200 Hz span	1 Hz
100 Hz span	1 Hz

Table A-14: Trigger

Characteristics	Description
Trigger mode	Free run and Triggered
Trigger event source	IF (Level comparator) External (TTL) IQ (Option 02, power comparator)
Internal trigger comparator data source	A/D output (IF level trigger) Frequency amplitude (Option 02) Time amplitude (Option 02)
Pre/Post trigger setting	Trigger position is settable from 0 to 100% of total data length.
IF level trigger setting range	1 to 100% (100% is full-scale of A/D output)
Event trigger (Option 02)	
Frequency domain	
Mask resolution	1 bin
Trigger level	0 to -60 dBfs
Real-time event detection bandwidth	5 MHz (1024-point FFT, 50% overlapping)
Time domain	
Trigger level	0 to -40 dBfs
External trigger input	
Input voltage	High: +1.6 to +5 V, Low: 0 to +0.5 V
Input impedance	>2 k Ω
Trigger output	High: >2.0 V, Low: <0.4 V (output current <1 mA)
Trigger marker position timing uncertainty	± 2 sample points

Table A-15: Measurement function

Characteristics	Description
S/A mode	Noise power, Channel power, Adjacent channel power ratio, Occupied bandwidth, Emission bandwidth, Carrier to Noise ratio, Carrier frequency, Spurious
Demod and Time modes	I/Q vs. Time, Power vs. Time, Frequency vs. Time, CCDF, Analog demodulation (AM, FM, PM), Digital demodulation (refer to Table A-11)

Table A-16: Display

Characteristics	Description
View	
Number of views	1, 2, 3, or 4
Number of display traces	2

Table A-16: Display (Cont.)

Characteristics	Description
LCD	
Size	213 mm (8.4 in)
Resolution	800 × 600 pixels
Color	Maximum 256 colors
Display detector	Positive peak, Negative peak, and Positive-Negative peak

Table A-17: Marker, trace, and display line

Characteristics	Description
Marker type	Normal, Reference, and Band power
Search function	Peak right, Peak left, Maximum, Larger peak, and Smaller peak
Trace content	Active, Average, Max Hold, Min Hold, View, and Off
Display line	Horizontal line 1 and 2, Vertical line 1 and 2

Table A-18: Controller and interface

Characteristics	Description
Controller	
CPU	Intel Pentium III 850 MHz
DRAM	256 Mbyte DIMM
OS	Windows 98
System bus	PCI, ISA
Storage medium	
Hard disk	10 Gbyte 2.5 inch IDE
Floppy disk	1.44 Mbyte 3.5 inch
Interface	
Printer port	USB
GPIB	IEEE 488.1
LAN	10/100 BASE-T (IEEE 802.3)
Mouse	USB
Keyboard	USB
Monitor out	VGA (D-SUB 15 pins)

Table A-19: Power requirements

Characteristics	Description
Rating voltage	100 to 240 VAC
Voltage range	90 to 250 VAC
Line frequency	47 to 63 Hz
Mains Fuse Data	Densei-Lambda supplies: 5 A, Time-delayed, 250 V (not operator replaceable) Cosel supply: 2 A, Time-delayed, 250 V (not operator replaceable)
Heat dissipation	
Maximum power	350 VA
Maximum line current	5 A rms at 50 Hz (90 V line with 5% clipping)
Surge current	Maximum 52 A peak (25 °C) for ≤5 line cycles after the product has been turned off for at least 30 s.

Table A-20: Power connector

Characteristics	Description
Preamp power connector	
Connector type	LEMO 6 poles
Pin assignment	Pin 1: NC, Pin 2: ID1, Pin 3: ID2, Pin 4: -12 V, Pin 5: GND, Pin 6: +12 V

Physical Characteristics

Table A-21: Physical characteristics

Characteristics	Description
Dimensions	
Width	425 mm (16.7 in) without belts
Height	215 mm (8.5 in) without feet
Depth	425 mm (16.7 in) without cover and feet
Net weight	19 kg

Environmental Characteristics

Table A-22: Environmental characteristics

Characteristics	Description
Temperature	
Operating	+10 to +40 °C
Nonoperating	-20 to +60 °C
Relative humidity	
Operating and nonoperating	20 to 80% (no condensation), maximum wet-bulb temperature 29 °C
Altitude	
Operating	Up to 3000 m (10000 ft)
Nonoperating	Up to 12000 m (40000 ft)
Vibration	
Operating	2.65 m/s ² rms (0.27 G rms), 5 to 500 Hz
Nonoperating	22.3 m/s ² rms (2.28 G rms), 5 to 500 Hz
Shock	
Nonoperating	196 m/s ² (20 G), half-sine, 11 ms duration Three shocks in each direction along each major axis, total of 18 shocks
Cooling clearance	
Bottom	20 mm (0.79 in)
Both sides	50 mm (1.97 in)
Rear	50 mm (1.97 in)

Table A-23: Certifications and compliances

Characteristic	Description																		
EC Declaration of Conformity – EMC	<p>Meets intent of Directive 89/336/EEC for Electromagnetic Compatibility. Compliance was demonstrated to the following specifications as listed in the Official Journal of the European Communities:</p> <table border="0"> <tr> <td>EN 61326</td> <td>EMC requirements for Class A electrical equipment for measurement, control and laboratory use. ¹</td> </tr> <tr> <td>IEC 61000-4-2</td> <td>Electrostatic discharge immunity (Performance criterion B)</td> </tr> <tr> <td>IEC 61000-4-3</td> <td>RF electromagnetic field immunity (Performance criterion A)</td> </tr> <tr> <td>IEC 61000-4-4</td> <td>Electrical fast transient / burst immunity (Performance criterion B)</td> </tr> <tr> <td>IEC 61000-4-5</td> <td>Power line surge immunity (Performance criterion B)</td> </tr> <tr> <td>IEC 61000-4-6</td> <td>Conducted RF immunity (Performance criterion A)</td> </tr> <tr> <td>IEC 61000-4-11</td> <td>Voltage dips and interruptions immunity (Performance criterion B)</td> </tr> <tr> <td>EN 61000-3-2</td> <td>AC power line harmonic emissions</td> </tr> <tr> <td>EN 61000-3-3</td> <td>Power line voltage fluctuation/flicker</td> </tr> </table>	EN 61326	EMC requirements for Class A electrical equipment for measurement, control and laboratory use. ¹	IEC 61000-4-2	Electrostatic discharge immunity (Performance criterion B)	IEC 61000-4-3	RF electromagnetic field immunity (Performance criterion A)	IEC 61000-4-4	Electrical fast transient / burst immunity (Performance criterion B)	IEC 61000-4-5	Power line surge immunity (Performance criterion B)	IEC 61000-4-6	Conducted RF immunity (Performance criterion A)	IEC 61000-4-11	Voltage dips and interruptions immunity (Performance criterion B)	EN 61000-3-2	AC power line harmonic emissions	EN 61000-3-3	Power line voltage fluctuation/flicker
EN 61326	EMC requirements for Class A electrical equipment for measurement, control and laboratory use. ¹																		
IEC 61000-4-2	Electrostatic discharge immunity (Performance criterion B)																		
IEC 61000-4-3	RF electromagnetic field immunity (Performance criterion A)																		
IEC 61000-4-4	Electrical fast transient / burst immunity (Performance criterion B)																		
IEC 61000-4-5	Power line surge immunity (Performance criterion B)																		
IEC 61000-4-6	Conducted RF immunity (Performance criterion A)																		
IEC 61000-4-11	Voltage dips and interruptions immunity (Performance criterion B)																		
EN 61000-3-2	AC power line harmonic emissions																		
EN 61000-3-3	Power line voltage fluctuation/flicker																		
Australia/New Zealand Declaration of Conformity – EMC	<p>Complies with EMC provision of Radiocommunications Act per the following standard(s):</p> <table border="0"> <tr> <td>AS/NZS 2064.1/2</td> <td>Industrial, Scientific, and Medical Equipment: 1992</td> </tr> </table>	AS/NZS 2064.1/2	Industrial, Scientific, and Medical Equipment: 1992																
AS/NZS 2064.1/2	Industrial, Scientific, and Medical Equipment: 1992																		
EC Declaration of Conformity – Low Voltage	<p>Compliance was demonstrated to the following specification as listed in the Official Journal of the European Union:</p> <p>Low Voltage Directive 73/23/EEC, amended by 93/68/EEC</p> <table border="0"> <tr> <td>EN 61010-1:2001</td> <td>Safety requirements for electrical equipment for measurement control and laboratory use.</td> </tr> </table>	EN 61010-1:2001	Safety requirements for electrical equipment for measurement control and laboratory use.																
EN 61010-1:2001	Safety requirements for electrical equipment for measurement control and laboratory use.																		
U.S. Nationally Recognized Testing Laboratory Listing	<table border="0"> <tr> <td>UL61010B-1</td> <td>Standard for electrical measuring and test equipment.</td> </tr> </table>	UL61010B-1	Standard for electrical measuring and test equipment.																
UL61010B-1	Standard for electrical measuring and test equipment.																		
Canadian Certification	<table border="0"> <tr> <td>CAN/CSA C22.2 No. 1010.1</td> <td>CSA safety requirements for electrical and electronic measuring and test equipment.</td> </tr> </table>	CAN/CSA C22.2 No. 1010.1	CSA safety requirements for electrical and electronic measuring and test equipment.																
CAN/CSA C22.2 No. 1010.1	CSA safety requirements for electrical and electronic measuring and test equipment.																		
Additional Compliance	<table border="0"> <tr> <td>ANSI/ISA S82.02.01:1999</td> <td>Safety standard for electrical and electronic test, measuring, controlling, and related equipment.</td> </tr> <tr> <td>IEC61010-1</td> <td>Safety requirements for electrical equipment for measurement, control, and laboratory use.</td> </tr> </table>	ANSI/ISA S82.02.01:1999	Safety standard for electrical and electronic test, measuring, controlling, and related equipment.	IEC61010-1	Safety requirements for electrical equipment for measurement, control, and laboratory use.														
ANSI/ISA S82.02.01:1999	Safety standard for electrical and electronic test, measuring, controlling, and related equipment.																		
IEC61010-1	Safety requirements for electrical equipment for measurement, control, and laboratory use.																		

¹ Emissions which exceed the levels required by this standard may occur when this equipment is connected to a test object.

Table A-23: Certifications and compliances (Cont.)

Characteristic	Description
Installation (Overvoltage) Category	<p>Terminals on this product may have different installation (overvoltage) category designations. The installation categories are:</p> <p>CAT III Distribution-level mains (usually permanently connected). Equipment at this level is typically in a fixed industrial location.</p> <p>CAT II Local-level mains (wall sockets). Equipment at this level includes appliances, portable tools, and similar products. Equipment is usually cord-connected.</p> <p>CAT I Secondary (signal level) or battery operated circuits of electronic equipment.</p>
Pollution Degree	<p>A measure of the contaminates that could occur in the environment around and within a product. Typically the internal environment inside a product is considered to be the same as the external. Products should be used only in the environment for which they are rated.</p> <p>Pollution Degree 1 No pollution or only dry, nonconductive pollution occurs. Products in this category are generally encapsulated, hermetically sealed, or located in clean rooms.</p> <p>Pollution Degree 2 Normally only dry, nonconductive pollution occurs. Occasionally a temporary conductivity that is caused by condensation must be expected. This location is a typical office/home environment. Temporary condensation occurs only when the product is out of service.</p> <p>Pollution Degree 3 Conductive pollution, or dry, nonconductive pollution that becomes conductive due to condensation. These are sheltered locations where neither temperature nor humidity is controlled. The area is protected from direct sunshine, rain, or direct wind.</p> <p>Pollution Degree 4 Pollution that generates persistent conductivity through conductive dust, rain, or snow. Typical outdoor locations.</p>
Safety Certification Compliance	
Equipment Type	Test and measuring
Safety Class	Class 1 (as defined in IEC61010-1, Annex H) – grounded product
Operating Temperature Range	+5 to +40 °C
Overvoltage Category	Overvoltage Category II (as defined in IEC61010-1, Annex J)
Pollution Degree	Pollution Degree 2 (as defined in IEC61010-1). Note: Rated for indoor use only.

Appendix B: Default Settings

The tables in this section list the default values for parameters set in the menus.

Pressing the **PRESET** key returns the analyzer to the default state for the measurement mode in use (S/A, Demod, or Time). Values for checked items (✓) in these tables are common to all measurement modes.

Table B-1: Measurement menu

Menu	S/A mode	Demod/Time mode	Common
FREQUENCY/CHANNEL			
Center Freq	1.5 GHz	1.5 GHz	✓
Start Freq	1.4925 GHz	-	✓
Stop Freq	1.5075 GHz	-	✓
Channel Table...	None	None	
Step Size (Center Freq)	200 kHz	200 kHz	
SPAN			
Span	15 MHz	15 MHz	✓
Start Freq	1.4925 GHz	-	✓
Stop Freq	1.5075 GHz	-	✓
AMPLITUDE			
Ref Level	0 dBm	0 dBm	✓
RF Atten / Mixer	Auto	Auto	✓
Mixer Level	-25 dBm	-25 dBm	✓
Vertical Scale	10 dB/div	-	
Vertical Units	dBm	-	
Corrections...		-	
Amplitude Offset	0 dB	-	
Frequency Offset	0 Hz	-	
Amplitude Table	Off	-	
Corrections...→ Interpolation			
Freq Interpolation	Lin	-	
Ampl Interpolation	dB	-	

Table B-1: Measurement menu (Cont.)

Menu	S/A mode	Demod/Time mode	Common
TIMING			
Acquisition Length	-	80 μ s	
Acquisition History	-	0	
Spectrum Length	-	40 μ s	
Spectrum Offset	-	0	
Analysis Length	-	80 μ s	
Analysis Offset	-	0	
TRIG			
Mode...	-	Free Run	
Repeat...	Continuous	Continuous	
RBW/FFT			
RBW/FFT	Auto	-	
TRACE/AVG			
Select Trace	1	-	
Trace 1	On	-	
Trace 1 Type...	Normal	-	
Number Of Averages	20	-	
Display Detection...	Max	-	
Average	-	Off	
Average Count	-	20	
Average Term Control	-	Expo	
MEASURE	Measurement Off	Measurement Off	

Table B-2: Display menu

Menu	S/A mode	Demod/Time mode	Common
DEFINE			
Grid Style	Fix	-	
Show Views	-	Multi	
Overview Content...	-	Waveform	
SCALE			
Horizontal Scale	15 MHz	80 μ s	
Horizontal Start	1.4925 GHz	-80 μ s	
Vertical Scale	100 dB	100 dB	
Vertical Stop	0 dBm	0 dBm	
LINES			
Show Line	Horizontal	-	
Number Of Line	None	-	
MARKER SETUP			
Marker X Position	0	0	
Markers	Off	Off	
Step Size (Marker X Position)	15 kHz	80 ns	
Peak Search Freq Threshold	300 kHz	-	
Peak Search Hor. Threshold	-	1.6 μ s	

Table B-3: Utility menu

Menu	S/A mode	Demod/Time mode	Common
INPUT			
Signal Input Port...	RF	RF	✓
Reference Source	Int	Int	✓

Appendix C: Inspection and Cleaning

Inspect and clean the exterior of the instrument as often as operating conditions require. Dirt acts as an insulating blanket, preventing efficient heat dissipation. Regular cleaning may prevent instrument malfunction and enhance reliability.



WARNING. To avoid personal injury, unplug the power cord from line voltage before cleaning the instrument. To avoid getting moisture inside the instrument during external cleaning, use only enough liquid to dampen the applicator.

Inspecting the Exterior

Inspect the outside of the instrument for damage, wear, and missing parts, using Table C-1 as a guide. Instruments that appear to have been dropped or otherwise abused should be checked thoroughly to verify correct operation and performance. Immediately repair defects that could cause personal injury or lead to further damage to the instrument.

Table C-1: External inspection check list

Item	Inspect for	Repair action
Cabinet, front panel, and cover	Cracks, scratches, deformations, damaged hardware or gaskets.	Contact your local Tektronix distributor or sales office.
Front-panel knobs	Missing, damaged, or loose knobs.	
Connectors	Broken shells, cracked insulation, and deformed contacts. Dirt in connectors.	
Carrying handle, bail, cabinet feet.	Correct operation.	
Accessories	Missing items or parts of items, bent pins, broken or frayed cables, and damaged connectors.	



CAUTION. *Avoid the use of chemical cleaning agents that might damage the plastics used in this instrument. Organic solvents such as benzene and acetone must never be used.*

Cleaning the Exterior

Remove the power cord before cleaning the instrument. Clean the exterior surfaces of the instrument with a dry, lint-free cloth or a soft-bristle brush. If dirt remains, use a cloth or swab dampened with a 75% isopropyl alcohol solution. A swab is useful for cleaning in narrow spaces around the controls and connectors. Do not use abrasive compounds on any part of the instrument.



CAUTION. *Do not allow moisture inside the instrument. During exterior cleaning, use only enough solution to dampen the cloth or swab.*

Lubrication

There is no periodic lubrication required for this instrument.

Cleaning the Interior

Consult your Tektronix Service Center or representative for cleaning the analyzer interior.

Appendix D: Options and Accessories

This appendix describes the options and standard and optional accessories that are available for the analyzer.

Options

The following options can be ordered for the analyzer:

- Option 1A: External preamplifier (20 dB gain to 3 GHz)
- Option 1R: Rack Mount Kit (includes: hardware and instructions for converting to 19-inch rackmount configuration)
- Option L5: Provides Japanese language user manual and programmer manual instead of English manuals.
- Option 02: 256 MB data memory with frequency mask trigger
- Option 03: IQ input function
- Option 22: UMTS/W-CDMA downlink analysis software
- Option 23: UMTS/W-CDMA uplink analysis software
- Option 24: GSM/EDGE analysis software
- Option 25: cdma2000 analysis software
- Option 26: cdma2000 1xEV-DO analysis software
- Option C3: Calibration service, 3 years
- Option C5: Calibration service, 5 years
- Option D1: Calibration data report
- Option D3: Calibration data report, 3 years (requires Option C3)
- Option D5: Calibration data report, 5 years (requires Option C5)
- Option R3: Repair service, 3 years
- Option R5: Repair service, 5 years
- Power cord options listed in Table D-1.

Table D-1: Power cord identification

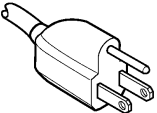
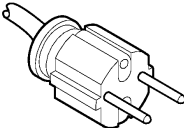
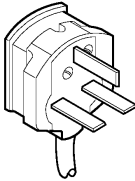
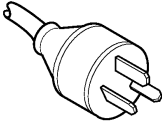
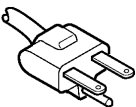
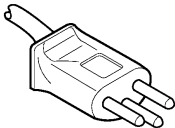
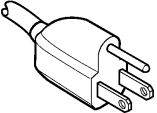
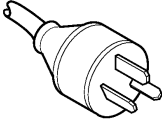
Plug configuration	Normal usage	Option number
	North America 120 V	A0
	Universal Euro 230 V	A1
	United Kingdom 230 V	A2
	Australia 240 V	A3
	North America 240 V	A4
	Switzerland 220 V	A5
	Japan 100 V	A6
	China 240 V	A10
	No power cord supplied.	A99

Standard Accessories

All analyzers in this series are shipped with the accessories listed in Table D–2.

Table D-2: Standard accessories

Accessory	Part number
English language user manual	071-1253-XX
English language programmer manual	071-1255-XX
U.S. power cord	161-0066-XX
USB mouse	119-B145-XX
USB keyboard	119-B146-XX
BNC–N adapter	103-0045-XX
Front cover	200-A524-50

Optional software includes the user manual listed in Table D–3.

Table D-3: Accessories for optional software

Accessory	Part number
Option 22 W-CDMA downlink analysis software user manual	071-1475-XX
Option 23 W-CDMA uplink analysis software user manual	071-1477-XX
Option 24 GSM/EDGE analysis software user manual	071-1479-XX
Option 25 cdma2000 analysis software user manual	071-1367-XX
Option 26 1xEV-DO analysis software user manual	071-1371-XX

Optional Accessories

You can order the accessories listed in Table D-4 to use with your analyzer.

Table D-4: Optional accessories

Accessory	Part number
Japanese language user manual	071-1254-XX
Japanese language programmer manual	071-1256-XX
Service manual	071-1257-XX
Accessory bag	016-A330-00
Preamplifier (20 dB gain to 3 GHz)	650-A900-XX
Rack mount kit (for field conversion)	

Glossary

Glossary

Accuracy

The closeness of the indicated value to the true value.

Acquisition

A series of time-contiguous Frames. This was previously called a Block.

Acquisition Time

The length of time contained in one acquisition.

Amplitude

The magnitude of an electrical signal.

Amplitude Modulation (AM)

The process, or result of a process, in which the amplitude of a sine wave (the carrier) is varied in accordance with the instantaneous voltage of a second electrical signal (the modulating signal).

Analysis Time

A subset of time-contiguous samples from one Block Time, used as input to an Analysis View.

Analysis View

Any view which produces measurement results except for Spectrum, Power versus Time, and Spectrogram.

Block

See *Acquisition*.

Calibrator

A signal generator producing a specified output used for calibration purposes.

Carrier, Carrier Signal

The electrical signal, typically a sine wave, upon which modulation is impressed.

Carrier Frequency

The frequency of the carrier signal.

Carrier-to-Noise Ratio (C/N)

The ratio of carrier signal power to average noise power in a given bandwidth surrounding the carrier; usually expressed in decibels.

Center Frequency

That frequency which corresponds to the center of a frequency span, expressed in hertz.

Clear (Erase)

Presets memory to a prescribed state, usually that denoting zero.

Controls

User-accessible mechanisms to modify setup parameters.

dBm

A unit of expressed power level in decibels referenced to 1 milliwatt.

dBmV

A unit to express voltage levels in decibels referenced to 1 millivolt.

dB μ V

A unit to express voltage levels in decibels referenced to 1 microvolt.

Decibel (dB)

Ten times the logarithm of the ratio of one electrical power to another.

Depth of Modulation

The difference between the maximum and the minimum of the RF envelope amplitude expressed as a percentage of the maximum RF envelope level.

Display Law

The mathematical law that defines the input-output function of the instrument. The following cases apply:

Linear

A display in which the scale divisions are a linear function of the input signal voltage.

Square Law (Power)

A display in which the scale divisions are a linear function of the input signal power.

Logarithmic

A display in which the scale divisions are a logarithmic function of the input signal voltage.

Display Line

A horizontal or vertical line on a waveform display, used as a reference for visual (or automatic) comparison with a given level, time, or frequency.

Display Reference Level

A designated vertical position representing a specified input level. The level may be expressed in dBm, volts, or any other units.

Distortion

Degradation of a signal, often a result of nonlinear operations, resulting in unwanted signal components. Harmonic and intermodulation distortion are common types.

Dynamic Range

The maximum ratio of the levels of two signals simultaneously present at the input which can be measured to a specified accuracy.

Export

Save data to a file in a format other than application-native.

FFT Time

The length of time covered by one frame, whether or not an RBW filter is applied to the FFT. This was previously called a “multi-frame”.

Filter

A circuit which separates electrical signals or signal components based on their frequencies.

Frame

A series of time-contiguous samples, long enough in duration and at a sufficient sample rate to produce a spectrum view of a specified span and RBW.

Frequency

The rate at which a signal oscillates, or changes polarity, expressed as hertz or number of cycles per second.

Frequency Band

The continuous range of frequencies extending between two limiting frequencies, expressed in hertz.

Frequency Domain Representation

The portrayal of a signal in the frequency domain; representing a signal by displaying its sine wave components; the signal spectrum.

Frequency Drift

Gradual shift or change in displayed frequency over the specified time due to internal changes in the spectrum analyzer, where other conditions remain constant. Expressed in hertz per second.

Frequency Modulation (FM)

The process, or result of a process, in which the frequency of an electrical signal (the carrier) is varied in accordance with some characteristic of a second electrical signal (the modulating signal or modulation).

Frequency Range

The range of frequencies over which the performance of the instrument is specified.

Frequency Span (Dispersion)

The magnitude of the frequency band displayed; expressed in hertz or hertz per division.

Graticule

The calibrated grid overlaying the display screen of spectrum analyzers, oscilloscopes, and other test instruments.

Grayed Out

An on-screen control is “Grayed Out” if it is not adjustable.

Import

Bring data into the application from a file of some format other than application-native

Input Impedance

The impedance at the desired input terminal. Usually expressed in terms of VSWR, return loss, or other related terms for low impedance devices and resistance-capacitance parameters for high impedance devices.

Intermediate Frequency (IF)

In a heterodyne process, the sum or difference frequency at the output of a mixer stage which will be used for further signal processing.

Key Contacts

A pattern of interlaced fingers on the front-panel circuit board that form a contact closure when mated with a conductive pad under a mechanical front panel button.

Link

Connect to a file containing settings or other data to be used by the application. Maintain the connection.

Live Trace

Any combination of the A trace and/or the B trace when SAVE A is off.

Load

Copy settings or other data from a file, but don't maintain any connection with that file.

Local Oscillator (LO)

An oscillator which produces the internal signal that is mixed with an incoming signal to produce the IF signal.

Marker

A visually identifiable point on a waveform trace, used to extract a readout of domain and range values represented by that point.

MAX HOLD (Peak Mode)

Digitally stored display mode which, at each frequency address, compares the incoming signal level to the stored level and retains the greater level. In this mode, the display indicates the peak level at each frequency after several successive sweeps.

MIN HOLD

A spectrum analyzer feature which captures the minimum signal amplitude at all displayed frequencies over a series of sweeps.

Modulate

To regulate or vary a characteristic of a signal.

Modulating Signal

The signal which modulates a carrier. The signal which varies or regulates some characteristic of another signal.

Modulation

The process of varying some characteristic of a signal with a second signal.

Noise

Unwanted random disturbances superimposed on a signal which tend to obscure it.

Noise Floor

The self-noise of an instrument or system that represents the minimum limit at which input signals can be observed. The spectrum analyzer noise floor appears as a “grassy” baseline in the display, even when no signal is present.

Open (Recall, Restore)

Bring data into the application from a file of application-native format.

Peak Detection

A detection scheme wherein the peak amplitude of a signal is measured and displayed. In spectrum analysis, 20 log (peak) is often displayed.

Platform Utility

User-available software applications provided with the instrument.

Primary Marker

The marker displayed in the Single Marker mode whose frequency and/or position is changed when tuning with the general purpose knob.

Reference Level

The signal level required to deflect the CRT display to the top graticule line.

Residual FM (Incidental FM)

Short term displayed frequency instability or jitter due to instability in the spectrum analyzer local oscillators. Given in terms of peak-to-peak frequency deviation and expressed in hertz or percent of the displayed frequency.

Residual Response

A spurious response in the absence of an input signal. (Noise and zero pip are excluded.)

Resolution Bandwidth (RBW)

The width of the narrowest filter in the IF stages of a spectrum analyzer. The RBW determines how well the analyzer can resolve or separate two or more closely spaced signal components.

Save

Commit data to memory in application-native format

Secondary Marker

The “second” marker displayed only in the Delta Marker mode.

Sensitivity

Measure of a spectrum analyzer’s ability to display minimum level signals, expressed in volts or decibels. Internal frequency (IF) bandwidth, display mode, and any other influencing factors must be given.

Shape Factor (Skirt Selectivity)

The ratio of the frequency separation of the two (60 dB/6 dB) down points on the response curve to the static resolution bandwidth.

Single Sweep

Operating mode in which the sweep generator must be reset for each sweep. Especially useful for obtaining single examples of a signal spectrum.

Span Per Division, Span/Div

Frequency difference represented by each major horizontal division of the graticule.

Spectrum

The frequency domain representation of a signal wherein it is represented by displaying its frequency distribution.

Spectrum Analysis

The technique or process of determining the frequency distribution of a signal.

Spectrum Analyzer

A device for determining the frequency components of a signal.

Spectrum Length

The amount of time required to acquire one frame.

Spurious Response

A response to a spectrum analyzer wherein the displayed frequency is not related to the input frequency.

Vertical Scale Factor, Vertical Display Factor

The number of dB, volts, etc., represented by one vertical division of a spectrum analyzer display screen.

View

An area or window of the display screen which contains information all of the same type (such as a Spectrum View or a Power versus Time View).

Index

Index

A

- A/D overflow, 3–90
- AC line frequency, 1–10
- Accessories, D–1
 - optional, D–4
 - standard, D–3
- ACPR measurement, 3–7
- Acquiring data, 3–109
- Acquisition history, description, 3–112
- Acquisition length, description, 3–112
- Address, Tektronix, xviii
- AM signal measurement, 3–37
- Amplitude
 - correction, 3–91
 - menu, 2–21
 - setting, 3–87
- Analog modulation analysis, 3–35
 - basic procedure, 3–35
- Analysis length, description, 3–113
- Analysis offset, description, 3–113
- Analysis range, setting, 3–29
- Architecture, 1–6
- Arrow keys, Markers menu, 2–36
- Auto Calibration side key, 1–22
- Auto level, 3–88
- Average, 3–131
 - Demod mode, 2–31
 - Time mode, 2–31
 - type, 3–134

B

- Backing up user files, 1–20
- Bin, relation between frame, bin, and pixel, 3–138
- Block diagram, 1–6
- Brightness
 - adjusting, 1–25
 - uneven, 1–19

C

- C/N measurement, 3–9
- CAL, 2–38
- Calibration, 1–21
- Carrier frequency measurement, 3–13
- Caution, RF INPUT, 1–12
- CCDF, view setting, 3–70
- CCDF measurement, 3–60

- basic procedure, 3–61
- Center offset calibration, 1–23
- Changing
 - overview, 3–32
 - subview, 3–32
- Channel power measurement, 3–5
- Channel table, using, 3–81
- Characteristics
 - electrical, A–1
 - environmental, A–15
 - physical, A–15
- Cleaning, C–1
- Compression, trace data, 3–138
- Connectors, 2–1
- Constellation
 - analysis, 3–47
 - view setting, 3–71
- Contacting Tektronix, xviii
- Continuous, trigger, 3–116
- Conventions, xvii
- Copy, screen, 3–181
- Correction, amplitude, 3–91
- Correction..., 2–23

D

- Data, acquisition, 3–109
- DC offset calibration, 1–24
- Default settings, B–1
- DEFINE, 2–33
- DEMOD, 2–32
- Demod mode, 3–27
- Difference between WCA230A and WCA280A, 1–2
- Digital modulation analysis, 3–42
 - basic procedure, 3–45
- Dimensions, A–15
- Display, dead pixel, 1–19
- Display line, operation, 3–149
- Display menu, 2–32
- Documentation list, xvi

E

- EBW measurement, 3–15
- Electrical characteristics, A–1
- Environmental characteristics, A–15
- EVM
 - analysis, 3–48
 - view setting, 3–72

External trigger input, specification, A-12
Eye diagram
 analysis, 3-51
 setting, 3-76

F

Features, 1-1
FFT
 description, 3-101
 points, 3-103
 setting parameters, 3-102
 window, 3-104
File
 entering a name, 3-160
 format, 3-163
 loading, 3-154
 operation, 3-153
 saving, 3-154
 type, 3-154
Floppy disk, using, 3-153
FM signal measurement, 3-38
Frame
 relation between frame, bin, and pixel, 3-138
 setting time parameters, 3-112
Free Run, trigger mode, 3-116
Frequency, setting, 3-79, 3-80
Frequency measurement, 3-59
FREQUENCY/CHANNEL, 2-18
Functional check, 1-14

G

Gain calibration, 1-21
General purpose knob, 2-2

H

Hard copy, screen, 3-181
HELP, 2-37

I

I/Q level measurement, 3-57
IF trigger, 3-120
INPUT, 2-38
Input, over-voltage, 3-90
Input source, selecting, 3-99
Inspection, C-1
Installation, 1-9
Interface, maps, 2-1

IQ input, description, 3-99
IQ level measurement, 3-41
IQ Level/Frequency measurement, DEMOD mode,
 3-49

K

Key, lock, 2-9
Keyboard, operation, 2-5
Keypad, 2-2
 entering a file name, 3-160
 using, 2-14

L

LAN, connection, 3-175
Level, trigger, 3-117
LINES, 2-33
LOAD, 2-39

M

MACRO, 2-41
MACRO SETUP, 2-41
Main view, modulation analysis screen, 3-28, 3-54
Manuals list, xvi
Map, interface, 2-1
Marker, operation, 3-141
MARKER SETUP, 2-35
Markers menu, 2-34
Max Hold, description, 3-134
MEAS SETUP, 2-31
MEASURE, 2-31
MEASUREMENT menu, 2-18
Menu
 details, 2-17
 operation, 2-11
Menu keys, 2-1
Min Hold, description, 3-134
Minimum jump, setting, 3-148
Mode, trigger, 3-116
Mode menu, 2-32
Modulation analysis (Demod mode), 3-27
Mouse, operation, 2-5

N

Network, settings, 3-176
Numeric input, 2-12

O

OBW measurement, 3–11
 Online help, using, 3–185
 Option, displaying, 3–189
 Option key, 3–190
 Optional accessories, D–4
 Options, D–1
 Overflow, A/D, 3–90
 Overview
 changing, 3–32
 modulation analysis screen, 3–28, 3–54
 Over-voltage input, 3–90

P

PEAK, 2–36
 Peak search, 3–141
 operation, 3–147
 setting minimum jump, 3–148
 Phone number, Tektronix, xviii
 Physical characteristics, A–15
 Pixel, relation between frame, bin, and pixel, 3–138
 PM signal measurement, 3–40
 Position, trigger, 3–119
 Power
 AC requirements, 1–10
 connecting the cord, 1–10
 Power measurement, 3–58
 Power switch, 1–11
 Powering off, 1–18
 Powering on, 1–10, 1–11
 PRESET, 2–39
 Principal power switch, 1–11
 PRINT, 2–40
 Print, screen copy, 3–181
 Product description, 1–1
 Product support, contact information, xviii

R

RBW
 description, 3–101
 setting parameters, 3–102
 RBW/FFT, 2–28
 Real Time S/A, operation, 3–22
 Real-time analysis, 1–3
 S/A mode, 3–22
 Rear panel, 2–2
 Repeat, trigger, 3–116
 Restart, 1–19
 RF INPUT, Caution, 1–12

RMS, description, 3–134
 RMSE_{Expo}, description, 3–134
 RUN/STOP, 2–25

S

S/A, 2–32
 S/A mode, 3–1
 S/A with Spectrogram, operation, 3–20
 SAVE, 2–40
 Scalar mode, span, 3–85
 SCALE, 2–33
 Scan Disk, 1–19
 Screen, configuration, 2–6
 Screen copy, 3–181
 Seamless acquisition, 3–111
 SELECT
 MARKERS, 2–34
 VIEW, 2–33
 Service support, contact information, xviii
 Setting, analysis range, 3–29
 Setup, display, 2–10
 Side keys, 2–1
 Side panel, 2–4
 Signal amplitude limit, 1–12
 Signal processing , 1–6
 Single, trigger, 3–116
 Single view, 3–34
 Slope, trigger, 3–118
 Source, trigger, 3–117
 SPAN, 2–19
 Span
 setting, 3–79, 3–80
 vector span, 3–85
 Specifications, A–1
 Spectrogram, S/A with Spectrogram, 3–20
 Spectrogram view, setting, 3–66
 Spectrum analysis (S/A mode), 3–1
 Spectrum length, description, 3–112
 Spectrum offset, description, 3–112
 Spectrum view, setting, 3–65
 Spurious signal measurement, 3–17
 Stand, setting up, 1–13
 Standard accessories, D–3
 Status, display, 2–8
 Step size
 center frequency, 2–15
 setting, 2–15
 Stop and Show Results, 3–110
 Subview
 changing, 3–32
 modulation analysis screen, 3–28, 3–54

Symbol table
 analysis, 3–50
 setting, 3–75
SYSTEM, 2–39

T

Technical support, contact information, xviii
Tektronix, contacting, xviii
TIME, 2–32
Time, setting parameters, 3–112
Time analysis (Time mode), 3–53
Time domain view, setting, 3–68
Time mode, 3–53
Time variation measurement, 3–56
 basic procedure, 3–56
TIMING, 2–24
Trace
 comparison, 3–131
 displaying, 3–132
 saving/loading, 3–137
TRACE/AVG, 2–29
TRIG, 2–25
Trigger, 3–115
 creating a mask, 3–123
 IF trigger, 3–120
 setting, 3–116
 specification, A–12
 trigger occurrence point, 3–130

 trigger output point, 3–130
 trigger point indicator, 3–130
Triggered, trigger mode, 3–116
Troubleshooting, 1–19
Tutorial, 2–43

U

UNCAL, 1–12
Unpacking, 1–9
URL, Tektronix, xviii
USB, connection, 3–177
Utility menu, 2–37

V

Vector mode, span, 3–85
Vector span, 3–85
Version, displaying, 3–189
View menu, 2–33

W

Web site address, Tektronix, xviii
Windows 98
 displaying the Windows desktop, 3–179
 using, 3–179